



DECOLAV®

MODEL NUMBER: 1112T SERIES

PRODUCT DESCRIPTION

Tempered Transparent Glass Vessel

- Translucence™ Collection
- 12 mm Glass
- 17" (43.18 cm) Round
- Tempered Natural Glass
- For Above Counter Use
- CSA Certified: CSA B45.0-02, CSA B45.11-04, IAPMO IGC172-2005



PRODUCT MEASUREMENTS

- Diameter: 17 inches (43.18 cm)
- Height: 5.5 inches (13.97 cm)

RECOMMENDED ACCESSORIES

- DECOLAV® 9020 Mounting Ring
- DECOLAV® 9290 Umbrella Drain or
- DECOLAV® 9296 Grid Drain
- DECOLAV® 9100 Decorative Bottle Trap

THANK YOU

Dear Valued Customer,
DECOLAV® would like to take this opportunity to thank you for your purchase – It is our sincere hope that you are completely satisfied with your new product. We welcome and look forward to helping you create another unique look for your next bathroom project.

Prior to installation, please take a moment to review all provided materials and hardware. For assistance with your new product, please contact our dedicated DECOLAV® customer service staff.

Sincerely,

Robert H. Mayer
Chief Executive Officer and President

*Let your dreams come alive,
Your passions become reality,
Be the envy of your neighbors™*



DECOLAV®

Changing the way you view the bathroom™

BEFORE YOU BEGIN

1. Prior to installation, unpack your new DECOLAV® product and inspect it. Keep the product in its original package until you are ready to install it.
2. The wall must be square, plumb and level.
3. Shut the water supply off when replacing an existing fixture. Preparation of the floors and walls, including all additional wall supports, may be required.
4. **Observe all local plumbing and building codes.**
5. It is recommended that this installation be done with a minimum of two people. Do not install this fixture alone.

Customer Service
561-274-2110
www.decolav.com



TOOLS REQUIRED

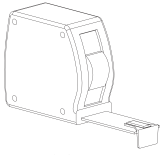

Tape Measure



Adjustable Wrench



Pipe Clamp



Channel Locks

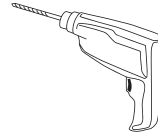

Drill



Hacksaw



Level

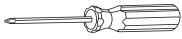

Phillips Screwdriver

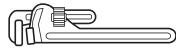

Pipe Wrench

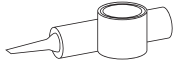

Plumber's Putty or Caulking



Putty Knife

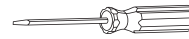

Flathead Screwdriver

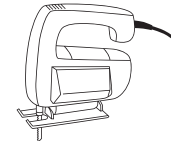

Scroll Saw

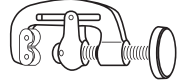

Pipe Cutter



Pencil

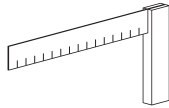

Square



Ruler

ROUGHING-IN DIMENSIONS

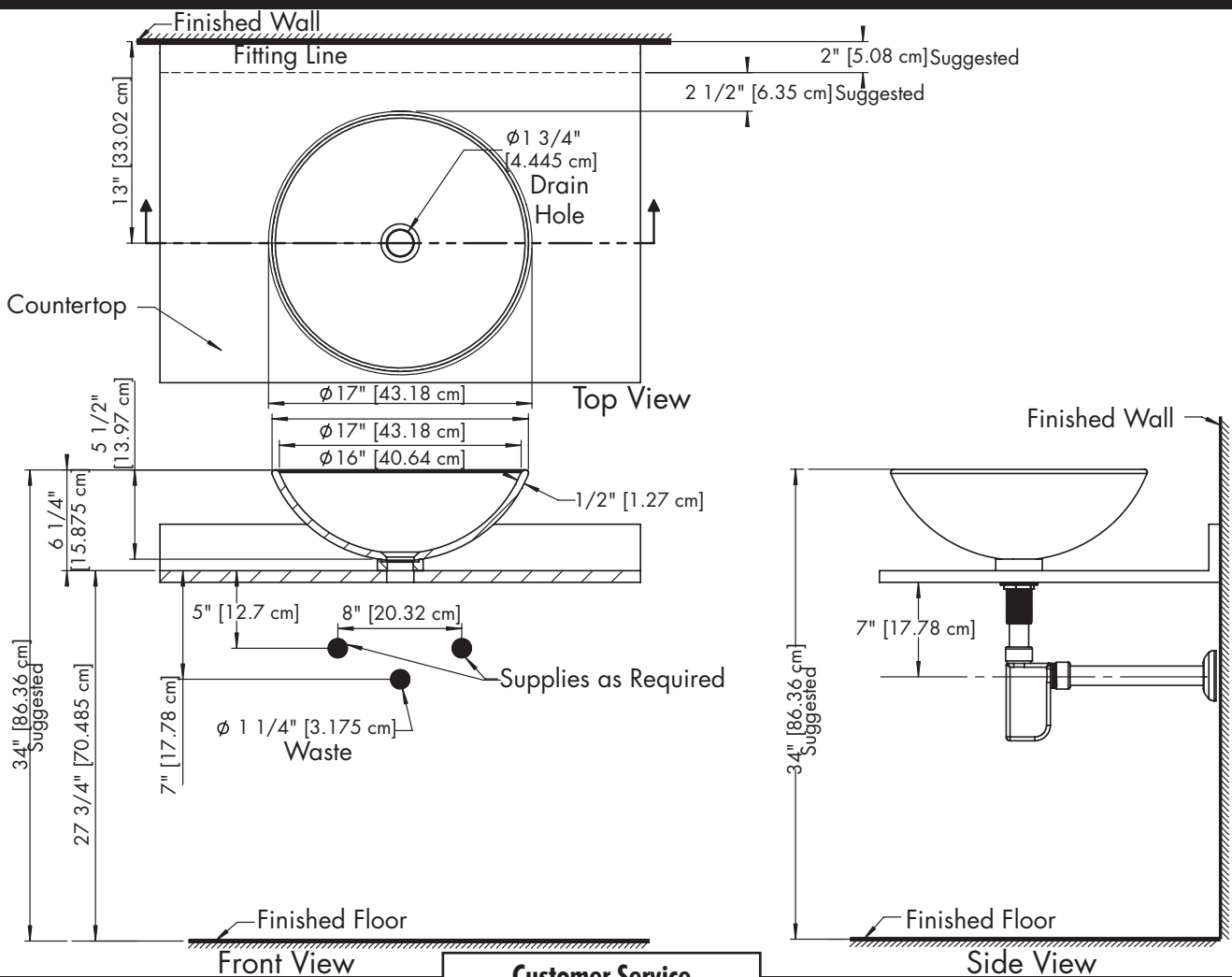

Customer Service
 561-274-2110
 www.decolav.com



PARTS

| Item | Description | Qty |
|------|-----------------------------------|-----|
| A | Tempered Transparent Glass Vessel | 1 |

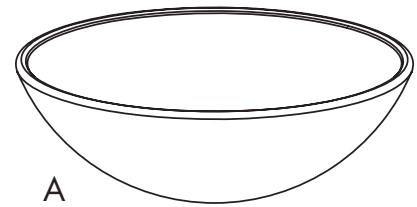

INSTALLATION INSTRUCTIONS

STEP #1

- o Prepare Countertop by drilling a 1 3/4" (4.445 cm) diameter drain hole at desired location.
- o **NOTE: MOUNTING RING SHOWN, DECOLAV® 9020 MOUNTING RING, IS A RECOMMENDED ACCESSORY AND NOT INCLUDED!**
- o Install Mounting Ring according to manufacturer's installation instructions.
- o Place **Lavatory (A)** on Mounting Ring or Countertop as shown.

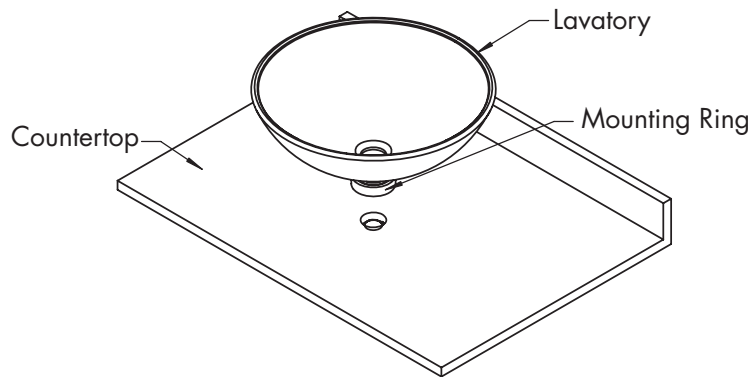

STEP #2

- o **NOTE: DRAIN SHOWN, DECOLAV® 9290 UMBRELLA DRAIN, IS A RECOMMENDED ACCESSORY AND NOT INCLUDED!**
- o Secure **Lavatory** to Countertop by installing Drain according to manufacturer's installation instructions.
- o **NOTE: DO NOT OVERTIGHTEN DRAIN!**
- o Refer to figure #1.

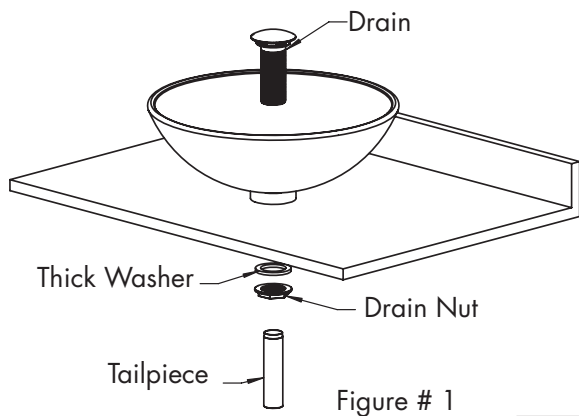
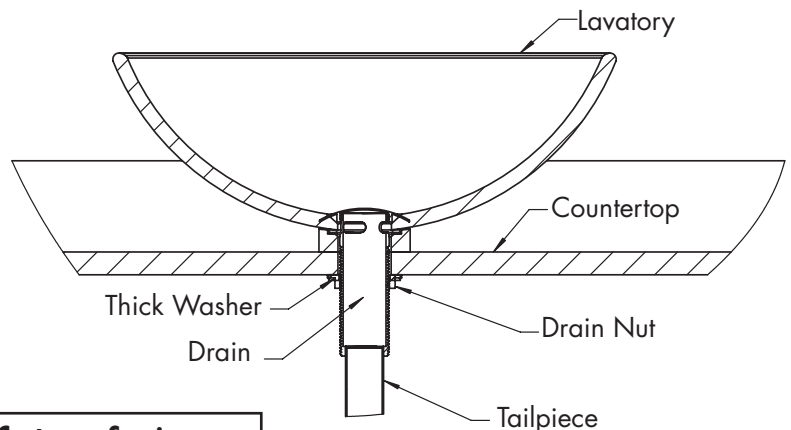

Figure # 1





INSTALLATION INSTRUCTIONS

• **STEP #3**

o **NOTE: WASTE SYSTEM SHOWN, DECOLAV® 9100 DECORATIVE BOTTLE TRAP, IS A RECOMMENDED ACCESSORY AND NOT INCLUDED!**

- o Install Waste System according to manufacturer's installation instructions.
- o Refer to figure #2.

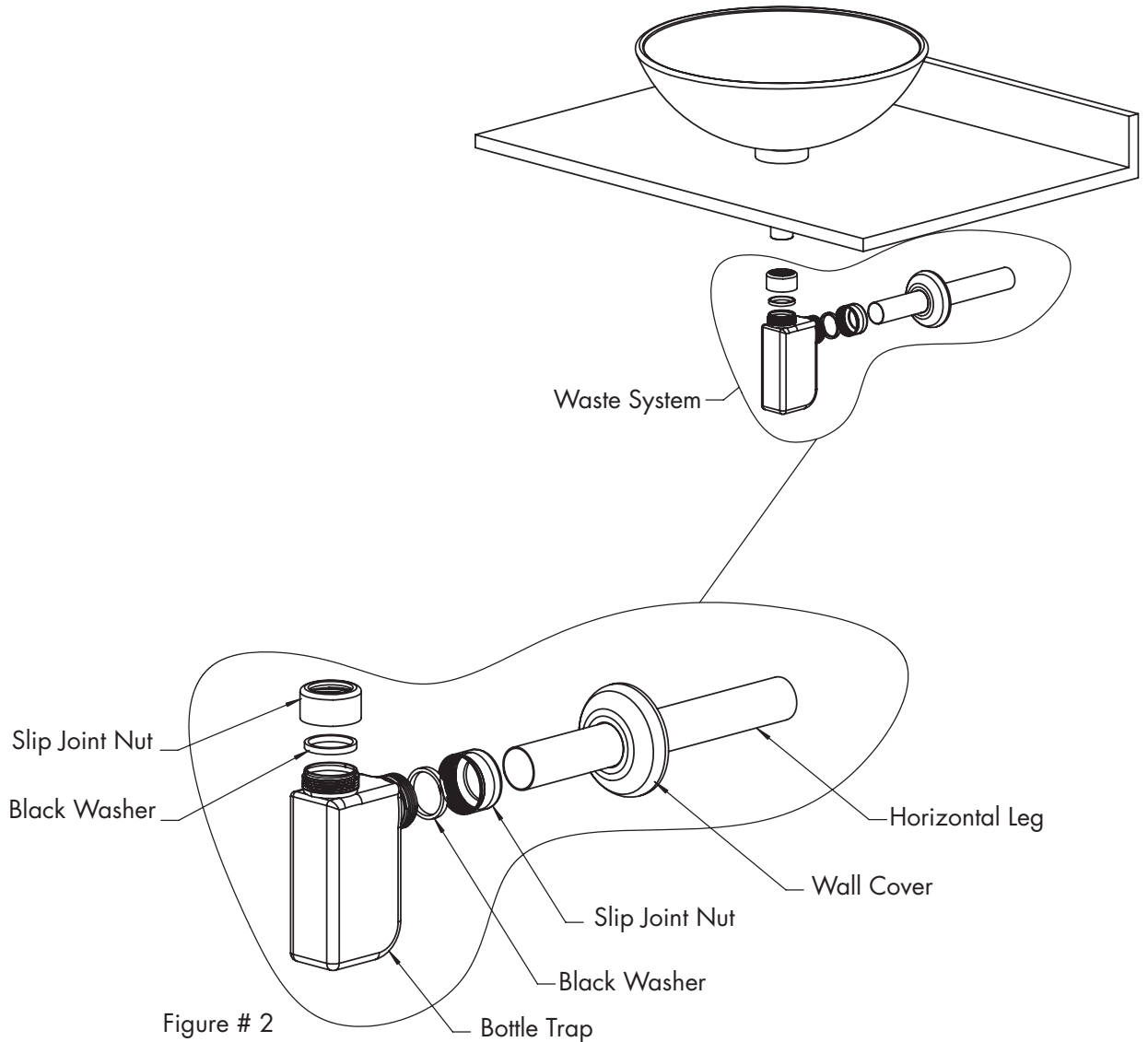

• **STEP # 4**

o Install faucet and water supply according to manufacturer's installation instructions.

o **NOTE: FAUCET AND WATER SUPPLY NOT INCLUDED!**

- o Check for leakage

**CARE AND CLEANING**

- **DO NOT OVERTIGHTEN DRAIN.** Overtightening of the drain can damage your DECOLAV® product.
- **DO NOT** clean the product with Detergents, Acid, Abrasives, Harsh Cleaners or a cloth with a coarse surface (S.O.S.® Pads, Scotch Brite® Pads). This is good advice for any plumbing fixture regardless of material.
- **DO NOT** leave any cleaning agents other than water on your DECOLAV® product.
- **DO NOT** allow your DECOLAV® product to unnecessarily encounter other solid objects.
- **DO** clean your DECOLAV® product. Wipe with a damp cloth and dry with a soft cloth. If necessary, a general mild soap and water solution can be used. Use a mild furniture polish to clean wood frame.
- **DO** clean underside of your DECOLAV® product with mild soap and water ONLY.
- **DO** wipe your DECOLAV® product with a clean, dry, soft cloth after each use, as it will limit water spots, especially in hard water areas.
- **DO** clean your DECOLAV® mirror. Wipe with a glass cleaner and a clean soft cloth. Use a mild furniture polish to clean wood frame.
- **DECOLAV® recommends proper sealing of ALL natural stone products PRIOR TO INSTALLATION.**

FULL LIFETIME WARRANTY

Any Deco Lav, Inc. ("DECOLAV") product(s), sold after January 1, 2006, will be warranted to the original end consumer to be free of true defect(s) in material and workmanship for life of the product(s) subject to the following restrictions:

- DECOLAV is notified promptly in writing, via fax or mail, by the Retail/Wholesale Purchaser upon discovery of any alleged defect(s) in the product(s), including a detailed description of the alleged defect(s).
- Proof of purchase (original sales receipt) from the original end consumer must be made available to DECOLAV for all warranty claims.
- Authorized DECOLAV personnel has inspected the product(s) and determined the product(s) to have true manufacturing defect(s).
- Such product(s) are returned to DECOLAV (unless other arrangements satisfactory to DECOLAV have been agreed upon).

This Lifetime Warranty is non-transferable and applies only to the original end consumer and to the original installation of the product(s). This Lifetime Warranty is void if the product(s) has been moved from its initial installation site or if ownership of the product(s) has changed.

THIS LIFETIME WARRANTY DOES NOT COVER ANY DAMAGES CAUSED BY SHIPPING, MISUSE, ABUSE, ACCIDENTS, NEGLIGENCE, UNAUTHORIZED REPAIRS OR ALTERATIONS, MODIFICATIONS, USE OF OTHER THAN GENUINE DECOLAV REPLACEMENT PARTS, DIRT, LIME SCALE, AND OTHER MINERALS, SCUFFS AND SCRATCHES, EXPOSURE TO MARINE AREAS, ABNORMAL USAGE, AND NORMAL WEAR AND TEAR. ANY IMPROPER INSTALLATION, IMPROPER MAINTENANCE, IMPROPER HANDLING, IMPROPER AND CONTRARY USES NOT STATED WITHIN INSTRUCTIONS, AND ALL ACTS BEYOND DECOLAV'S CONTROL WILL VOID THIS LIFETIME WARRANTY.

DECOLAV's product(s) are produced from natural raw materials and there is a slight color variance. This is **NOT** a manufacturing defect(s) and will not be covered under this Lifetime Warranty.

This Lifetime Warranty does not apply to local building code compliance. Since local building codes vary considerably, the original end consumer of the product(s) should check with a local building or plumbing contractor to ensure local code compliance before installation.

This Lifetime Warranty does not cover any mechanical pieces of any DECOLAV product(s). These mechanical pieces will be covered under a One Year Warranty, based on the same criteria as this Lifetime Warranty, from the date of the initial purchase.

Upon satisfaction of each of the foregoing conditions and requirements, DECOLAV shall, at its option, either repair or replace such defective product(s). DECOLAV shall return any product(s) repaired or replaced under this Lifetime Warranty to the original end consumer transportation prepaid. All Closeout/Discontinued product(s), at time of claim, will either be repaired or replaced with a comparable item.

DECOLAV's option to repair or replace the product(s) under this Lifetime Warranty does not cover any cost of labor to remove or install the DECOLAV product, usage and delay time, or other costs of removal or installation whatsoever. **IN NO EVENT WILL DECOLAV BE LIABLE FOR THE COST OF REPAIR OR REPLACEMENT OF ANY INSTALLATION MATERIALS, INCLUDING BUT NOT LIMITED TO, TILES, MARBLE, ETC.**

This Lifetime Warranty does not cover any liability for consequential or incidental damages, all of which are hereby expressly disclaimed, or the extension beyond the duration of this Lifetime Warranty. Some states do not allow the exclusion or limitation of incidental or consequential damages, so the above limitation or exclusion may not apply to you.

THE WARRANTIES HEREIN (A) ARE EXCLUSIVE AND STATED IN LIEU OF ALL OTHER WARRANTIES, WHETHER EXPRESS, STATUTORY, OR IMPLIED, INCLUDING BUT NOT LIMITED TO THE WARRANTIES OF MERCHANTABILITY AND FITNESS FOR AN INTENDED PURPOSE, ALL OF WHICH ARE HEREBY EXPRESSLY DISCLAIMED; (B) NEITHER ASSUME NOR AUTHORIZE PURCHASER NOR ANY OTHER PARTY TO ASSUME FOR DECOLAV ANY OTHER LIABILITIES IN CONNECTION WITH THE MANUFACTURE OR SALE OF PRODUCTS; AND (C) ARE SUBJECT TO THE LIMITATIONS ON DAMAGES AS SET FORTH ABOVE