

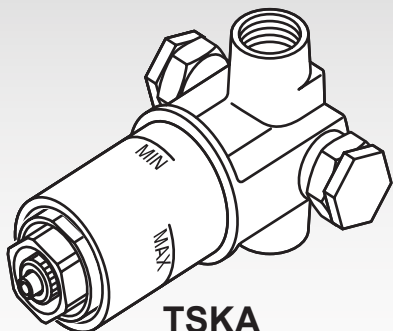

Installation and Owner's Manual

Volume Control Valves

RENESSETM



TSKA
Single Volume Control Valve

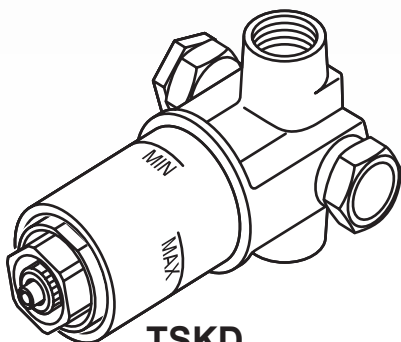

TSKD
Dual Volume Control Valve

English

Español

Français

Contents

Important Safeguards-----	1
Specifications -----	2
Before Installation -----	2
Set-up Drawing-----	3
Components -----	3
Installation Procedure -----	4~5
Set-up Options -----	6
Replacement Parts-----	6
Warranty-----	7

● Thank you for your recent purchase of the TOTO product . Please read the enclosed information to ensure the safe use of your product

Important Safeguards



(For your safety please follow the instructions below)





Read the "Important Safeguards" section thoroughly before installing the product.

•The following symbols indicate safe and proper use of the product. Failure to observe them may result in injury or property damage.





The symbols and their meanings are as follows.



•The following table demonstrates the use of safety symbols in this manual.

 Warning	Failure to observe this symbol may result in serious injury.
 Caution	Failure to observe this symbol may result in injury or property damage.

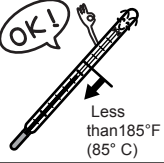
	 Absolutely Do NOT. Do not disassemble
	 Mandatory!

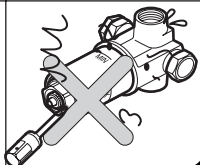
ENGLISH

 Warning		
 Do Not	Do not use hot water supply that is higher than 185°F (85°C). Do not use steam as hot water supply. If water is hotter than 185°F is used. If it is broken, property damage, scalding, and other injuries may occur.	
 Do not disassemble	Do not disassemble or modify the item in any way not described in this manual If the system is broken, property damage, scalding and other injuries are likely to occur.	

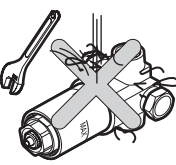
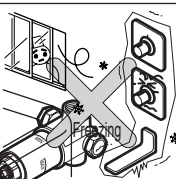
 Caution		
 Do Not	Do not strike or kick the product. If the system is broken, property damage, scalding, and other injuries may occur.	
	Do not use the product at temperature exceeding what local codes allow. If parts are damaged, property damage, scalding and other injuries may occur.	

Specification

Water Supply Pressure	Minimum pressure	20 psi (0.15MPa)(flowing pressure)
	Maximum pressure	125 psi (0.75MPa)(static) <small>Check local building code</small>
Supplied Water Temperature		Less than 185°F (85°C)
Water Quality		Water that meet National/Primary drinking water regulation
Ambient Temperature		34 - 104°F (2~40°C)
Water Supply Connection		1/2" NPT
Humidity		Maximum 90% RH

Depending on the model, some specifications may differ.

Before Installation

- Observe all local plumbing codes.
 - Make sure water supply is shut off.
 - Read these instructions carefully to ensure proper installation.
 - Check to make sure you have the following parts indicated below.
- If the water supply pressure is higher than 125psi (0.86MPa), you should buy a reducing valve to reduce the pressure to the range of 0.2-0.3MPa (0.2-0.3MPa).
To use the faucet comfortably, the recommended pressure is about 30-45 psi (0.2-0.3MPa).
 - To prevent being scalded due to malfunction, the cold water supply pressure must be higher than the hot water pressure, or you can make them equal. In addition, if you increase the pressure of the hot water, it still must be lower than that of cold water supply side.
 - To prevent being scalded due to wrong operation, it is recommended the hot water supply temperature is 140°F (60°C).
 - For ease of water flow adjustment and inspection with tools, you should prepare an extra stop valve.

Set-Up Drawing

*Some parts may differ from the illustration depending on the model.

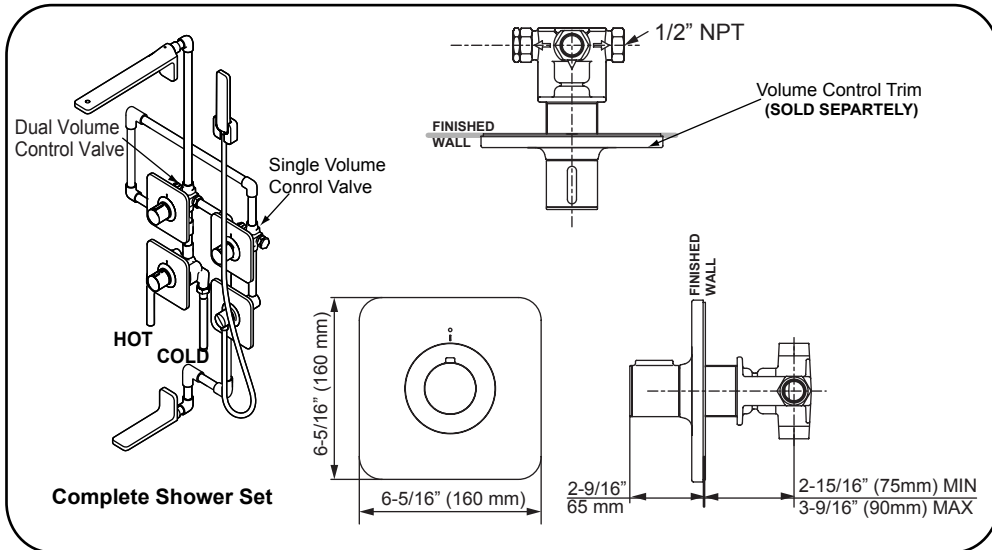

ENGLISH

Components

Check that you have the following parts.

TSKA

TSKD

Tools you will need



Pipe Tape



Adjustable Wrench



Allen Wrench

TOTO

Owner's and Installation manual

*Some parts may differ from the figures depending on the model.

Installation Procedure

Information below should be observed in order to properly install the shower.

Preparation

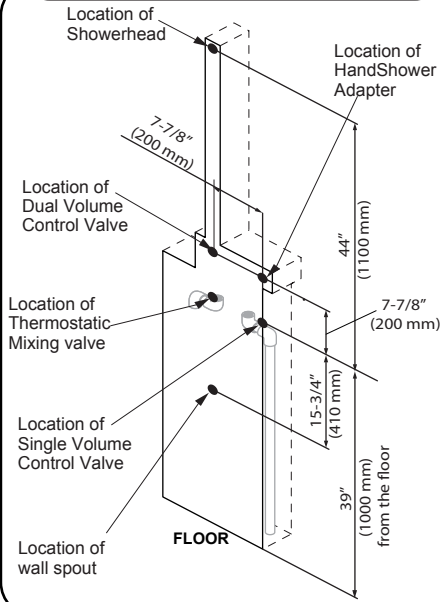

Plumbing Setup

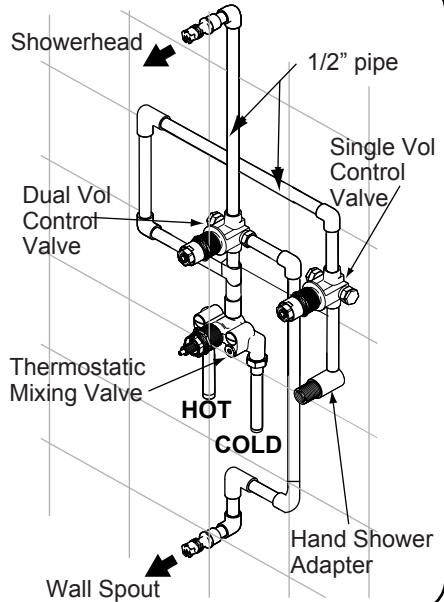

- 1 Install and connect valves with 1/2" pipe

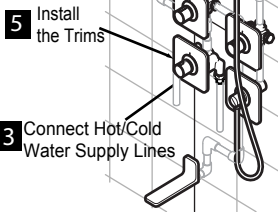

- 5 Install the Trims
- 3 Connect Hot/Cold Water Supply Lines
- 4 Finish the wall.
- 2 Clean water supply pipes by draining

Refer to the respective manual for each item for Step 1 to Step 4.

PAY SPECIAL ATTENTION TO WATER IN AND OUT DIRECTIONS OF VALVES.

TSKA (Single Volume Control Valve)

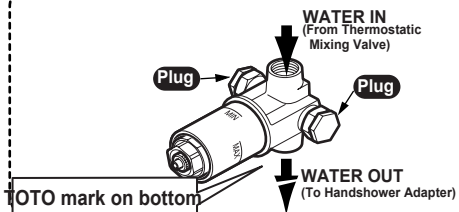

TSKD (Dual Volume Control Valve)

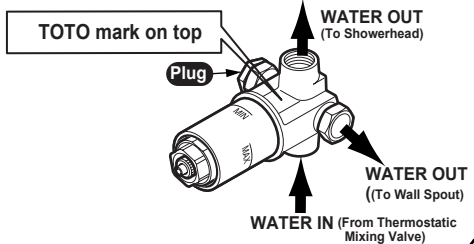

Installation of Volume Control Valve (s)

- ① Confirm the rough-in mentioned in the Set-up Drawing and Install the volume control valve(s)
- ② Connect the valve (s), Single Volume Control and/or Dual Volume Control, (please see the Shower Set up Options for Renesse Shower options) with Thermostatic Mixing Valve.

Pay special attention to flow directions of the valve(s), mentioned in the previous page. PLUG THE UNUSED OUTLETS BEFORE INSTALLATION.

Before installation, dirt and debris in the water supply pipes must be washed out.

- ③ Connect the valves with the water supply lines. Make sure that there is no leakage in the connections.

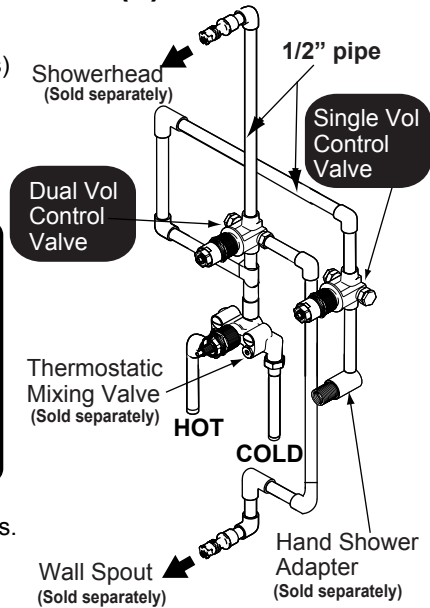

Finishing the wall

- ① Make sure with the guard cover provided that distance between Finished Wall surface and valve falls between MIN and MAX.

If the distance is beyond the MIN and MAX limit, valve trims cannot be mounted properly.

Must confirm wall, both rough and finished, thickness and distance to the valves before installing the valves.

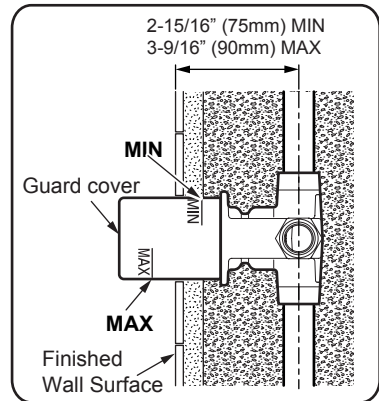

Caution

Leave the guard covers on the valves till the tile work is completed.

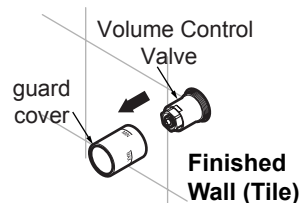

Set-Up Options

1) Complete Set

2) w/o Handshower

3) w/o wall spout

4) Showerhead only

4

Product Description	Part Number
Showerhead	TS170A#CP
Bath Spout	TS170E#CP
Hand Shower Trim	TS170F#CP
Single Volume Control Trim for Hand Shower	TS170C1#CP
Hand Shower Adapter	TSKH
Dual Volume Control Trim	TS170D#CP

Product Description	Part Number
Thermostatic Mixing Valve Trim	TS170T#CP
SMA Thermostatic Mixing Valve	TSKT
Single Volume Control Trim for Head Shower	TS170C#CP
Single Vol Control Valve	TSKA
Dual Volume Control Valve	TSKD

#CP = Polished Chrome

ENGLISH

Replacement Parts

No.	Description
1	ESCUTCHEON
2	VOLUME CONTROL RETAINER NUT
3	SCREW AND WASHER
4	VOLUME CONTROL STEM
5	DUAL VOLUME CONTROL STEM CLIP
6	STOPPER
7	VOLUME CONTROL/DIVERTER VALVE
8	O-RINGS

Warranty

LIFETIME LIMITED WARRANTY

Warranty applies to selected residential faucets only.

1. TOTO® warrants its faucets ("Product") to be free from defects in materials and workmanship during normal residential use for as long as the original consumer end-user purchaser owns their home. This limited lifetime warranty is extended only to the original consumer end-user purchaser and only so long as the Product remains in use by the original consumer end-user purchaser in its original place of installation in the purchaser's residence. This warranty applies only to Product purchased and installed in North America.

2. TOTO® obligations under this warranty are limited to repair or replacement, at TOTO®'s option, of Product or parts found to be defective in normal residential use, provided that such Product was properly installed and used in accordance with the owner's manual. TOTO® reserves the right to make such inspections as may be necessary in order to determine the cause of the defect.

3. This warranty does not apply to the following items:

- Damage or loss sustained in a natural calamity such as fire, earthquake, flood, thunder, electrical storm, etc.
- Damage or loss resulting from any accident, unreasonable use, misuse, abuse, negligence, or improper care, cleaning or maintenance of the Product.
- Damage or loss resulting from sediments or foreign matter contained in a water system.
- Damage or loss resulting from improper installation or from installation of the Product in a harsh and/or hazardous environment, or improper removal, repair or modification of the Product.
- Damage or loss resulting from the use of an abrasive cleanser.

4. If the Product is used commercially, TOTO® warrants the Product to be free from defects in materials and workmanship for one (1) year from the date the Product is installed, with all other terms of this warranty applicable except the duration of the warranty.

5. THIS WARRANTY GIVES YOU SPECIFIC LEGAL RIGHTS. YOU MAY HAVE OTHER RIGHTS, WHICH VARY FROM STATE TO STATE OR PROVINCE TO PROVINCE.

6. To obtain warranty repair service under this warranty, you must take the Product or deliver it prepaid to a TOTO® service facility with proof of purchase (original sales receipt) together with a letter stating the problem, or contact a TOTO® distributor or products service contractor, or write directly to TOTO® U.S.A., INC., 1155 Southern road, Morrow, Georgia 30260, (888) 295-8134. If, because of the size of the Product or nature of the defect, the Product cannot be returned to TOTO®, receipt by TOTO® of written notice of the defect together with proof of purchase (original sales receipt) shall constitute delivery. In such case, TOTO® may choose to repair the Product at the purchaser's location or pay to transport the Product to a service facility.

THIS WRITTEN WARRANTY IS THE ONLY WARRANTY MADE BY TOTO®. REPAIR, REPLACEMENT OR OTHER APPROPRIATE ADJUSTMENT AS PROVIDED UNDER THIS WARRANTY SHALL BE THE EXCLUSIVE REMEDY AVAILABLE TO THE ORIGINAL PURCHASER. TOTO® SHALL NOT BE RESPONSIBLE FOR LOSS OF THE PRODUCT OR FOR OTHER INCIDENTAL, SPECIAL OR CONSEQUENTIAL DAMAGES OR EXPENSES INCURRED BY THE ORIGINAL PURCHASER, OR FOR LABOR OR OTHER COSTS DUE TO INSTALLATION OR REMOVAL, OR COSTS OF REPAIRS BY OTHERS, OR FOR ANY OTHER EXPENSE NOT SPECIFICALLY STATED. IN NO EVENT WILL TOTO®'S RESPONSIBILITY EXCEED THE PURCHASE PRICE OF THE PRODUCT. EXCEPT TO THE EXTENT PROHIBITED BY APPLICABLE LAW, ANY IMPLIED WARRANTIES, INCLUDING THAT OF MERCHANTABILITY OR FITNESS FOR USE OR FOR A PARTICULAR PURPOSE, ARE EXPRESSLY LIMITED TO THE DURATION OF THIS WARRANTY. SOME STATES AND PROVINCES DO NOT ALLOW LIMITATIONS ON HOW LONG AN IMPLIED WARRANTY LASTS, OR THE EXCLUSION OR LIMITATION OF INCIDENTAL OR CONSEQUENTIAL DAMAGES, SO THE ABOVE LIMITATION AND EXCLUSION MAY NOT APPLY TO YOU.