



Specifications

# SBF 80 G1 Series

Super Quiet Bathroom Ventilation Fan

**Description:** Low RPM, low noise, ceiling mount bathroom fan engineered for continuous operation • Suitable for new construction, or remodeling • HVI certified • ENERGY STAR qualified • UL/cUL listed for use in insulated ceilings (Type I.C.).

**Motor/Blower:** Permanently lubricated enclosed condenser motor engineered for continuous operation; power rating 120v/60Hz; motor equipped with thermal shut off.

**Housing:** Rust proof paint on steel body; 4" duct connector with built-in back draft dampener; easy installation anti-vibration brackets included; designed for installation in ceilings with minimum of 8" clearance.

**Grille:** Low maintenance, wipe clean; attaches to housing with torsion springs

**Ventilating Area:** For bathrooms up to 80 sq ft.

**Installation:** Complete installation instructions included

**Shipping Weight:** 15 lbs

**Warranty:** 6 Years

**Architect's Specifications:** Ventilation fan will be ceiling mount, ENERGY STAR qualified, with no less than 80 CFM and no more than 0.3 Sones as certified by HVI at 0.1 static pressure in inches water gauge. Power consumption shall be no greater than 22.9 watts and ENERGY STAR rated with an efficiency rating of no less than 3.5 CFM/watt. The motor will be permanently lubricated, engineered for continuous operation. Duct diameter will be 4" round. Fan shall be UL/cUL listed for tub/shower enclosure when used with GFCI branch circuit wiring and shall be UL/CUL listed for use in insulated ceiling (Type I.C.). Fan shall be ASHRAE 62.2, LEED, California Title 24, and Washington VIAQ compliant.

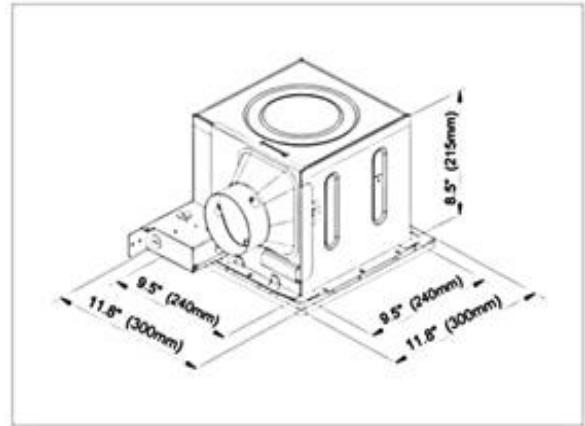

UL/CUL Listed for installation over tub/shower enclosure when used with GFCI circuit wiring



G1 Grille



Model: SBF 80 G1 Series	4" Duct	
Static Pressure (inches w.g.)	0.1	0.25
Air Volume (CFM)	80	64
Noise (sones)	<0.3	n/a
Power Consumption (Watts)	22.9	22.0
Energy Efficiency (CFM/Watts)	3.5	2.9
Speed (RPM)	817	1009
Current (AMPS)	0.16	0.16
ENERGY STAR rated	Yes	
Grille Dimensions	11 5/6" x 11 5/6"	

Model	Qty	Comments	Project
			Location
			Architect
			Engineer
			Contractor
			Submitted by
			Date