

# Installation Care and Cleaning

## Bathtub Wall Panel Systems

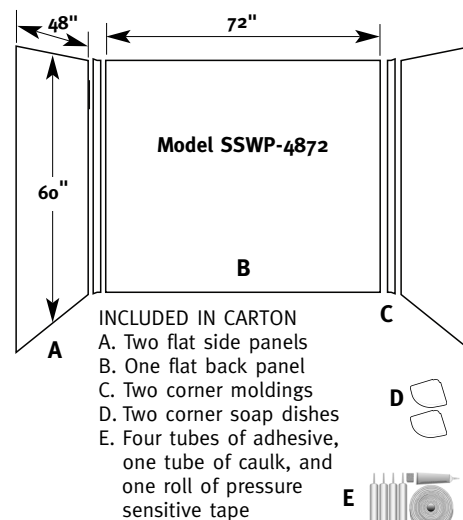
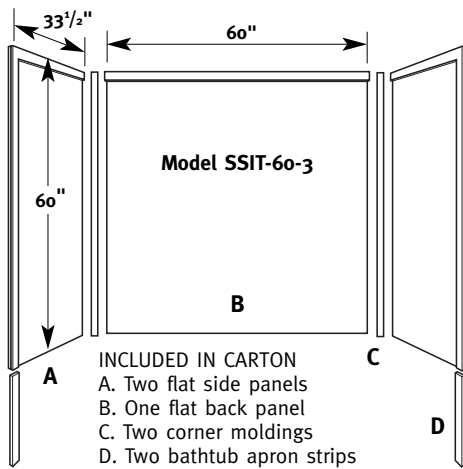
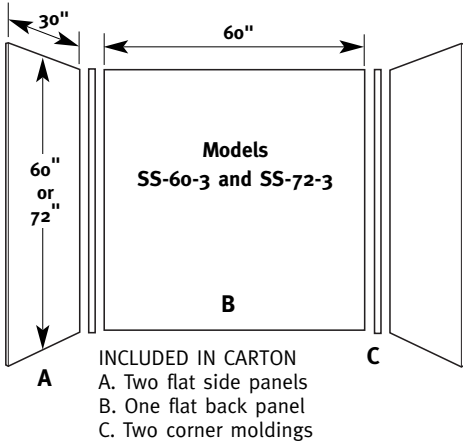

Kits that include caulk, adhesive, and pressure sensitive tape are sold separately.

### CAUTION

Read **ALL** instructions carefully **BEFORE** starting your installation. Save this manual for future reference.

## Bath Shower Wall Panels

**Model SS-3072-1**  
Single Swanstone wall panel 30"x72"

**Model SS-3672-1**  
Single Swanstone wall panel 36"x72"

**Model SS-3696-1**  
Single Swanstone wall panel 36"x96"

**Model SS-4896-1**  
Single Swanstone wall panel 48"x96"

**Model SS-6060-1**  
Single Swanstone wall panel 60"x60"

**Model SS-6072-1**  
Single Swanstone wall panel 60"x72" each

## Decorative Wall Panels

**Models:**  
DWP-3696BA Barcelona  
DWP-3696BB Beadboard  
DWP-3696BS Brushed Squares  
DWP-3696GO Geometric  
DWP-3696PB Pebble  
DWP-3696TN Tangier  
DWP-9636WB Wainscot Beadboard

Single Swanstone decorative wall panel 36"x96"

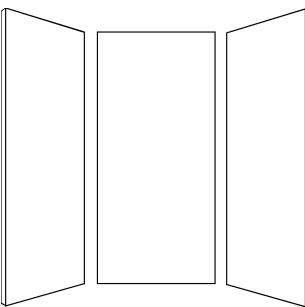
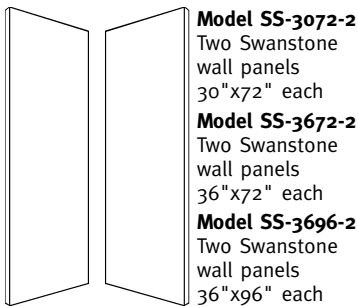

Kits that include caulk, adhesive, and pressure sensitive tape are sold separately. It may be necessary to combine panels to accommodate desired installation.

## Shower Wall Panel Systems

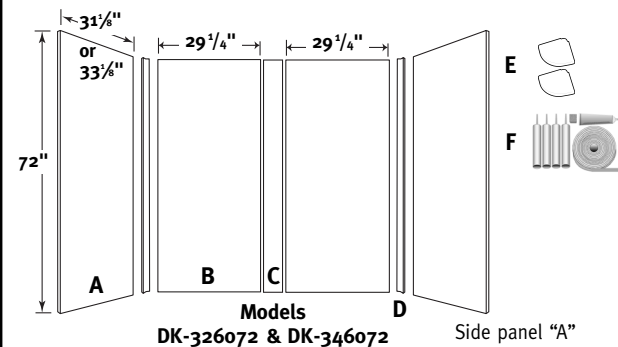
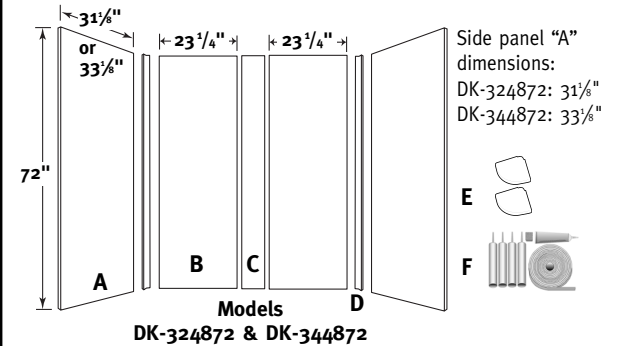
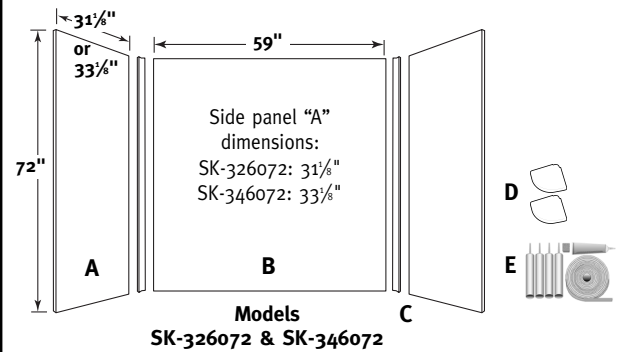
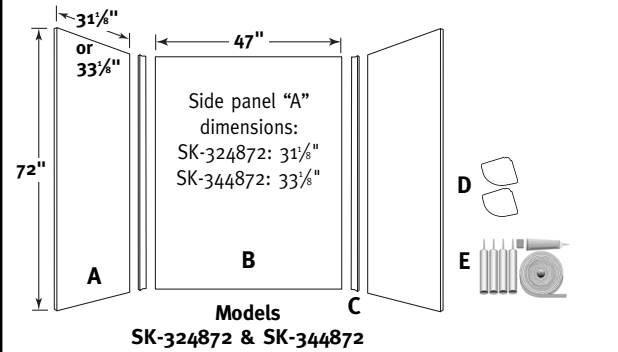
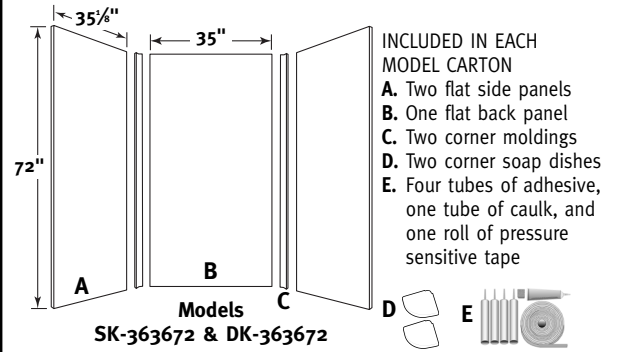

**INCLUDED IN EACH MODEL CARTON**

A. Two flat side panels B. Two flat back panels  
C. One batten strip D. Two corner moldings  
E. Two corner soap dishes  
F. Four tubes of adhesive, one tube of caulk, and one roll of pressure sensitive tape

## WALL SURFACE PREPARATION FOR SWANSTONE TUB WALL AND SHOWER WALL UNITS

### When installing over SHEETROCK/GREENBOARD/WOOD:

- A.** Surface must be dry, smooth, and free of any dust, soap scum or any other contaminants. Wipe wall surface with a damp cloth.
- B.** To insure proper adhesion between the Swanstone product and Sheetrock/Greenboard/Wood, it is best to use a primer/sealer, and it is **IMPORTANT** to follow these guidelines: Oil based primer/sealers (such as Bin-Seal, or all purpose enamel paint) should **NOT** be used to cover the entire wall surface (Sheetrock/Greenboard/Wood) but only should be applied at the areas where the double-faced tape adheres to the wall surface. Water based primer/sealers (such as latex paint) **MAY** be used to cover the entire wall surface (Sheetrock/Greenboard/Wood).
- C.** After the proper primer/sealer is completely dry, complete the installation following the installation instruction sheet.

### When installing over PLASTER:

- A.** Surface must be dry, smooth and free of any dust, soap scum or any other contaminants. Wipe wall surface with a damp cloth.
- B.** The wall surface (textured/swirled finish must be sanded smooth) must be sealed with a primer (Bin-Seal or other primer/sealer).
- C.** After primer/sealer is completely dry, complete the installation following the installation sheet.

### When installing over CEMENT/CONCRETE:

- A.** Surface must be dry, smooth and free of any dust, soap scum or any other contaminants. Wipe wall surface with a damp cloth.
- B.** The complete area must be sealed with two coats of primer. (Bin-Seal or other primer/sealer).
- C.** After primer/sealer is completely dry, complete the installation following the installation sheet.

### NOTE:

- CERAMIC: LOOSE TILE MUST BE REMOVED.**
- PLASTIC: ALL TILES MUST BE REMOVED.**

### When installing over OLD TILE:

- A.** Rough up the glossy tile surface by belt sanding the wall area with 60-grit sandpaper.
- B.** Surface must be dry, smooth and free of any dust, or any other contaminants. Wipe wall surface with a damp cloth.
- C.** For proper adhesion, the wall surface must be sealed with a primer (Bin-Seal or other primer sealer).
- D.** After primer/sealer is completely dry, complete the installation following the installation sheet.

### When installing over WALL PAPER:

- A.** All wallpaper must be removed from the area to be covered. Surface must be dry, smooth and free of any dust, soap scum or any other contaminants. Wipe wall surface with a damp cloth.
- B.** The complete wall surface area to be covered by unit must be sealed with two coats of primer (Bin-Seal or other primer sealer).
- C.** After primer/sealer is completely dry, complete the installation following the installation sheet.

### When installing over MASONITE:

- A.** Surface must be dry, smooth and free of any dust, soap scum or any other contaminants. Wipe wall surface with a damp cloth.
- B.** For proper adhesion, the wall surface must be sealed with a primer (Bin-Seal or other primer sealer).
- C.** Complete the installation following the installation sheet.

## NOTE

The Swanstone SS-29 Installation Kit (an accessory — p.3) contains the four tubes of adhesive, one tube of caulk, and one roll of pressure sensitive tape needed for installation. This kit is suggested for installing the SS-60-3, SS-72-3 and SSIT-60-3. To mount individual Swanstone wall panels, the SS-72 installation kit will be needed.

## TOOLS NEEDED TO INSTALL

Saber saw, drill, ruler, caulking gun and tools needed for faucet work.

## CUTTING AND ROUTING TOOLS

- Circular saw: Minimum 40-tooth carbide blade (triple chip grind, 60-tooth will give a smooth, clean cut).
- Portable power plane with carbide blades or cutter heads.
- Saber Saw (straight up/down blade travel). Fine plywood carbide blade or blade with no tooth overhang (14 teeth per inch).

To mount panels to wall we suggest that your purchase the SS-72 installation kit for each panel that you plan to install.

## DO NOT NAIL PANELS TO TUB WALLS

Panels mount to walls with adhesive and pressure sensitive tape.

## IMPORTANT SS-60-3 and SS-72-3 only

Measure the width of the back wall. If it measures more than 60", the SS-60-3 or SS-72-3 cannot be installed.

If your bath area is more than 29" deep, the side panels will not come flush to the front edge of the tub. For bath areas 32" deep, the TK-6072 trim kit may be required. You must follow the procedures, as directed, in the Swanstone trim kit installation instructions.

## FILLER BOARD

Measure the height of the tiles from the tub ledge upward. If the tiles measure less than 59 5/8", it is necessary to install a filler board. The filler board must equal the thickness of the tile. Usually, 1/4" masonite or similar material is adequate. For best results, extend the filler board from the top tile edge to the ceiling.

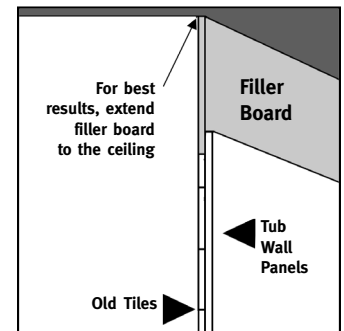

## IMPORTANT SSIT-60-3

Measure the width of the back wall. If it measures more than 60", Model SSIT-60-3 cannot be used. Model SS-IT-60-3 is designed to overhang the front edge of the bathtub. To give a finished look to your installation, the bathtub apron strips may be cut to fit the wall area in front of the bathtub.

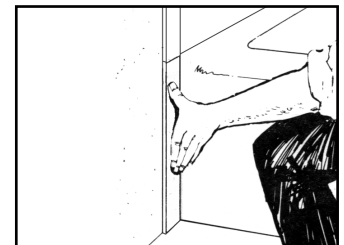

Side panels can be notched so the integral trim butt-joints to the back panel. However, this is not required as long as the corner molding seals the joint below the integral trim area.

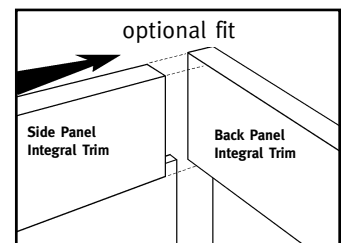

## ACCESSORIES

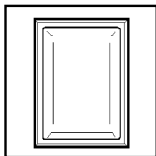

**AS-1075**  
Recessed  
Accessory Shelf

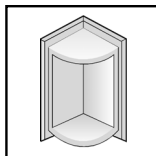

**SS-7211**  
Corner Soap Dish

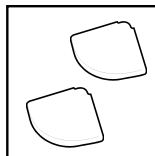

**ES-2**  
Two corner Soap  
Dishes included  
with SK-363672,  
SK-344872, and  
SS-326072 show-  
er wall panel  
system.



**SS-29**  
Installation Kit.  
The SE-363672,  
SK-344872, and  
SK-326072  
includes all instal-  
lation materials

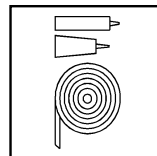

**SS-72**  
Installation Kit

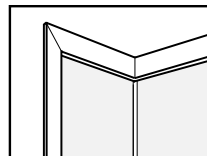

**Wall Panel Trim Kits**  
**TK-6072** Fits Swanstone 60"  
and 72" high bathtub and  
shower wall panel system.  
**TK-105** Fits Swanstone 96"  
high shower wall panel sys-  
tems including NEO 96" walls.

### TK-0372

Batten Strip includes  
one 3-3/4" x 72" flat  
batten strip.

## READ ALL INSTALLATION INSTRUCTIONS (INCLUDING ANY ACCESSORIES) BEFORE STARTING.

### INSTALLATION PROCEDURE

Allow panels to adjust to room temperature (65° to 90°) for at least 6 hours.

Next, turn off hot and cold water supply, remove faucet handles, escutcheons, filler spouts and any fittings mounted to the wall that will be covered i.e. towel bars, soap dishes, etc.

Use hammer and chisel to remove objects cemented to walls. Old ceramic tiles, if solidly adhered to walls, may be covered with this kit and need not be removed.

Loose ceramic tiles must be removed and sub walls sanded smooth.

Front edge ceramic tiles may be reset for appearance only. Remove soap film and all dirt from wall surface using detergent. Wipe dry. Wall surface must be dry before panels can be applied.

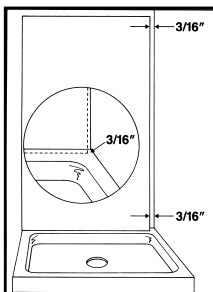

### NOTE

If installing a Corner Shower Unit (DTF Double Threshold or NEO):

Select either wall for initial panel installation. Measure out from the wall which is perpendicular (right angle) to the wall you selected 3/16" onto the shower floor threshold. You will locate the lower back corner of the Swanstone panel on this mark. This will allow symmetrical panel location as both panels extend from the corner along the wall to the front edge of the shower floor. There must NEVER be more than 3/16" gap between the first panel and the perpendicular (right angle) wall. If a gap greater than 3/16" exists, it may be necessary to shim the panel slightly.

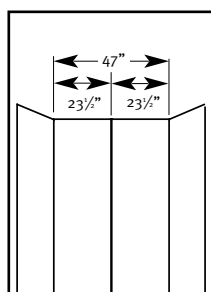

### MULTIPLE PANEL APPLICATION FOR BACK WALL:

Measure the distance along the back wall. The width of the panel will determine the procedure to use. If the back wall is greater than the overall width of the panel, a second panel, or possibly a third, will be required. When multiple panels are installed, divide the distance by two, or three if a third panel is required, and transfer that measurement to each of the back panels. Trim panels using tools as directed in step one. Repeat steps two and three. **NOTE:** Set trimmed edges into the corner of the shower area. They will be covered with side panel.



### 1. IF TRIMMING IS REQUIRED

Transfer measurements of the back wall onto the back wall panel. Cut the panel from the back side with a saber saw. Sand the cut edge with fine or medium sandpaper.



### 2. BACK WALL

Apply the pressure sensitive tape (see SS-29 or SS-72 installation kit) 1" from each edge. Apply adhesive as shown above. Keep adhesive at least one inch from the tape.

### IMPORTANT

Trial fit before you begin. Swanstone panels have a finished surface side and a non-finished backer side. Before trial fit, note which side of the Swanstone panel has a sticker or stickers attached. This will be the non-finished backer side and, upon installation, should be placed against the sub-wall.

### MEASURE BEFORE YOU START

The Swanstone wall panel system allows for variety of size applications. One-, two-, or three-panel cartons may be combined for installing over any shower floor situation.

### NOTE

We recommend that professional installers be consulted on applications for Swanstone panels not covered in these installations instructions.



**3.** Remove the backing from the pressure sensitive tape. Carefully, place panel edge into the corner (left or right) and press firmly into place. Use hand pressure up and down, side-to-side, to make firm contact to the wall.

**3a.** If your wall panel kit requires a batten strip application, apply a 1/8" bead of adhesive to the back of the batten strip. Keep the adhesive at least one inch from the panel edges.

Carefully, center the panel and firmly press, from top to bottom, making sure of a solid contact.

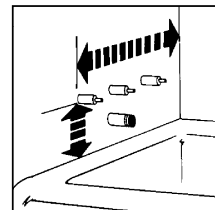

### 4. SIDE WALL

If wall or tub are out of square, cut the bottom edge of side panel(s) for a level edge across the top from the back panel(s). Measure location of the plumbing outlets from the back wall forward and from the top tub ledge upward. Transfer these measurements to the side panel.



**5.** Cut holes 1/2" larger than the diameter of the pipes. Drill from the finished side of the panel. For best results place a scrap of wood beneath the hole to be made. This will ensure a clean cut.

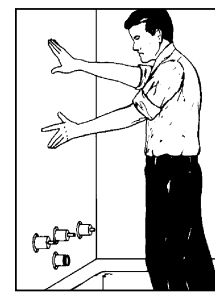

**6.** Trial fit each panel before proceeding. For an attractive installation, it is important that the top edges properly align.

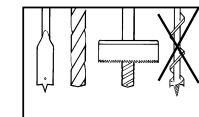

### IMPORTANT

USE ROUTER, SPADE BITS, TWIST DRILLS OR HOLE SAWS ONLY.



**7.** Apply adhesive and tape as indicated in step two.

## Trial Fit All Panels Prior To Final Application

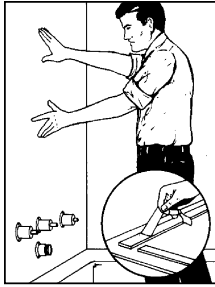

**8.** Remove the backing from the pressure sensitive tape. Place the appropriate panel edge carefully into the corner seam and press entire panel firmly to the wall. Use hand pressure up and down and side-to-side. Make sure all areas are in solid contact with the wall. Repeat the above for the opposite panel.

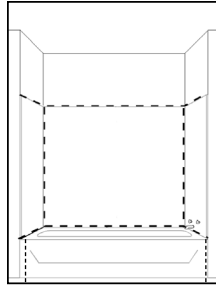

**9. CAULKING**  
Follow the instructions on the caulking tube and apply a bead of caulk along the bottom and top edge of the back and side walls. Also apply caulk to all vertical seams and edges.

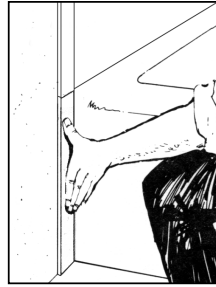

**10. BATHTUB APRON STRIP INSTALLATION, SSIT-60-3 ONLY.**  
Apron strips provide a finished look to your installation. Measure the wall area in front of the bathtub and cut the apron strips to fit. Apply a bead of adhesive to back of apron strips and press into place. Adhesive cures overnight.

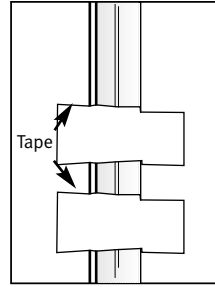

**11. CORNER MOLDING**  
Trial fit placement of corner moldings and transfer the height measurement of the vertical seam to the corner molding. Trim moldings and apply a  $3/16$ " bead of adhesive in each corner seam. Press corner moldings firmly into appropriate corners. Immediately remove any excess adhesive with a damp cloth. Temporarily secure corner moldings to the back and side walls with masking tape.

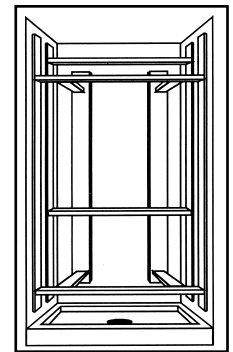
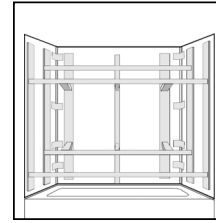

### NOTE

To promote contact until adhesive sets, use temporary bracing and allow adhesive to cure overnight. Temporary bracing may be constructed by wedging, as illustrated, lengths of 1 x 2's, 2 x 2's, and 1 x 3's.

### POSITIVELY NO HAMMERING OR NAILING IS TO BE DONE

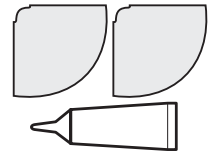

## ES-2 SOAP DISHES INSTALLATION

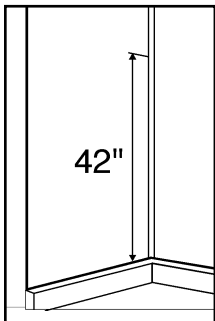

**1.** Select a desirable location for the mounting of the soap dish. While Swan recommends a minimum distance of 42" from the shower floor ledge to the soap dish, you may choose to stack the soap dishes in one corner or set them in opposite corners.

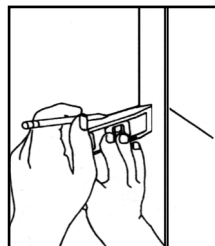

**2.** After settling on a location, draw a 4" level line on both walls. These lines will be used to line up the top edges of the soap dish.

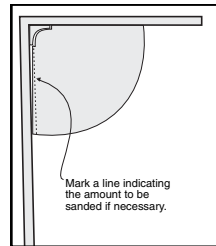

**TRIAL FIT**  
**3.** Prior to applying adhesive, set the soap dish into position. This will insure that it will fit tightly against the wall. If the wall is not exactly 90 degrees square, it will be necessary to sand one side in order to achieve proper fit. Use a course grit (60 grit) sandpaper.

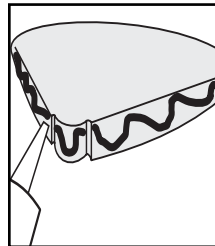

**4.** Apply a generous amount of adhesive to both sides and the sculpted back of the soap dish.

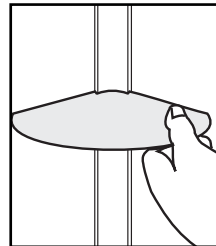

**5.** Line up to the 4" level line and press and hold into place. Wipe off excess adhesive. You will want a uniform bead on both top and bottom.

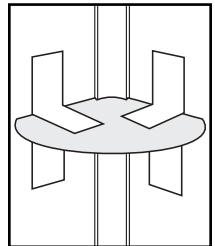

**7.** Temporarily secure with masking tape as illustrated. Remove tape after approximately two hours. Do not place anything on the soap dish for at least 24 hours.

### NOTE

You may have extra color coordinated caulk left over from your Swanstone wall installation. If this is the case, you can run a bead of caulk around the soap dish installation. Do this after the adhesive has dried.

### CLEANING

Clean your Swanstone Bathtub panels as you would any other fine bath fixture, using normal household detergents and cleansers. Just wiping the wall surfaces, quickly removes watermarks and residue. Occasional scrubbing with household abrasive cleansers maintains Swanstone's beautiful luster.

### REPAIRING

Use 400 grit sandpaper to remove scratches and gouges in the surface. A "Scotchbright pad" can be used to blend the repair into the surrounding area.