

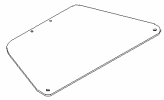

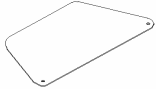

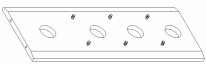

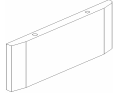





Model AVM-005

Components List

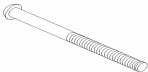
| Part Name | Part Details | | | Qty |
|-----------|---|----------------------------------|---|-----|
| | Description | Specification | Figure | |
| TB Glass | Glass for top and bottom shelves | Size: 610*520mm Thickness:8mm |  | 2 |
| M Glass | Glass for middle shelves | Size:610*495mm Thickness:8mm |  | 3 |
| CT | Cable tidy | Size: Thickness: |  | 1 |
| F-WD | Foot (Wood Support) | Size: Thickness |  | 1 |
| TB-1 | Tube | Length:146mm Diameter:50mm |  | 6 |
| TB-2 | Tube | Length:246mm Diameter:50mm |  | 2 |
| FT | Foot Tube | Length:130mm Diameter:50mm |  | 2 |
| CC-L | Chrome Cap | Diameter:50mm Thickness:8mm |  | 2 |
| CC-S | Chrome Cap | Diameter:28mm Thickness:8mm |  | 2 |
| I B-1 | I bolt (NO.1) | Length:45mm Diameter:6mm |  | 2 |
| IB-2 | I bolt (NO.2) | Length:35mm Diameter:10mm |  | 2 |
| I B-3 | I bolt (NO.3) | Length:50mm Diameter:10mm |  | 8 |
| F B | Foot bolt (Attached in the cable tidy) | Length:90mm Diameter:6mm |  | 2 |
| T E S | Tube send seal | Diameter:50mm Thickness:2mm |  | 18 |
| TOOL-1 | 3# Tool (screw IB-1) | |  | 1 |
| TOOL-2 | 5# Tool (screw IB-2 and IB-3) | |  | 1 |

Model AVM-005

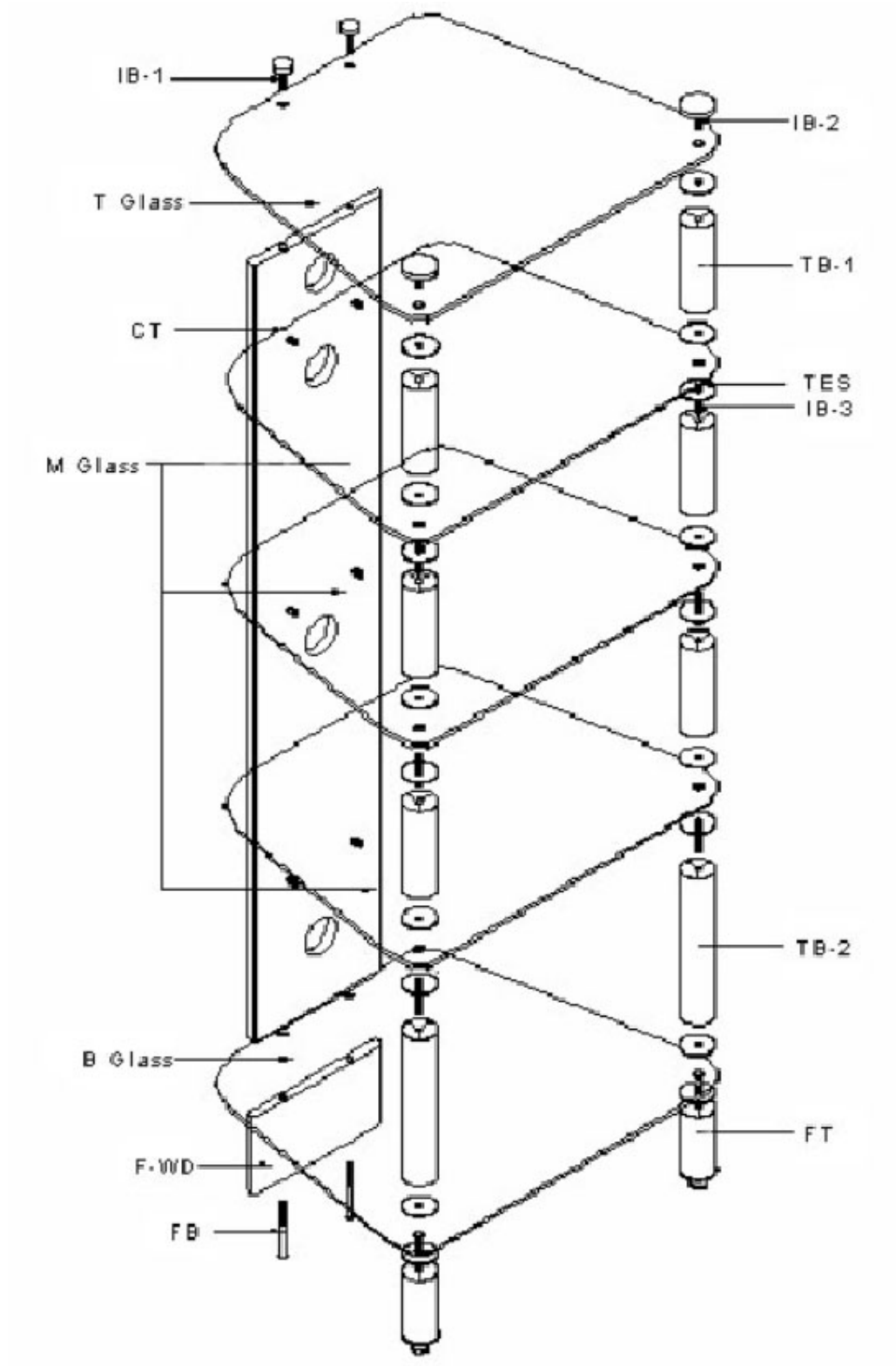

Model AVM-005

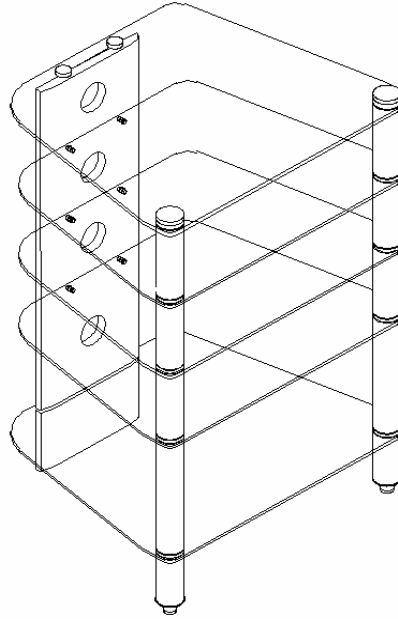

Stage 1

Please note stand is best assembled from the bottom up.

- 1.1 Place foot bolts (FB) through bottom shelf (B Glass), Foot (F-WD) and the holes at the bottom of the cable tidy (CT). Then screw the foot bolts into the cable tidy nuts until tight.
- 1.2 Screw in I bolts (IB-3) to top of each foot tube (FT).
- 1.3 Place I bolts in the foot tubes through bottom shelf. Then screw tubes (TB-2) onto each exposed bolt until tight.
- 1.4 Screw in I bolts to the top of each tube (TB-2).
- 1.5 Place middle shelf (M Glass) in position over each tube leg with I bolts passing through holes in each corner of the shelf and resting on support pegs located on cable tidy.
- 1.6 Repeat the same stage of 1.5 to assemble other middle shelves.

Stage 2

- 2.1 Screw tubes (TB-1) onto I bolts until tight.
- 2.2 Screw in I bolts (IB-2) to top of tubes (TB-1).
- 2.3 Place top shelf over I bolts resting on tubes.
- 2.4 Secure top shelf (T Glass) with chrome caps. (Screw the large chrome caps to the top of the tubes and screw the small chrome caps to the holes of cable tidy until tight.)