



















Model CT-009

Components List

Part Name	Part Details			Qty
	Description	Specification	Figure	
G-1	Glass(NO.1)	Size:400*220mm; Thickness:8mm		1
G-2	Glass(NO.2)	Size:400*220mm; Thickness:8mm		1
G-3	Glass(NO.3)	Size:1080*620mm; Thickness:8mm		1
G-4	Glass(NO.4)	Size:1080*200mm; Thickness:8mm		1
G-5	Glass(NO.5)	Size:620*310mm; Thickness:8mm		1
TB-1	Tube(NO.1)	Length:; Diameter:		2
TB-2	Tube(NO.2)	Length:528mm; Diameter:50mm		1
TB-3	Tube(NO.3)	Length:430mm; Diameter:50mm		1
TB-4	Tube(NO.4)	Length:178mm; Diameter:50mm		2
TB-5	Tub(NO.5)	Length:86mm; Diameter:50mm		2
TB-6	Tube(NO.6)	Length:718mm; Diameter:50mm		1
TB-7	Tube(NO.7)	Length:620mm; Diameter:50mm		1
CC	Chrome Cap	Diameter:50mm; Thickness:8mm		4
I B-1	I bolt (NO.1)	Length:25mm; Diameter:10mm		2
I B-2	I bolt (NO.2)	Length:50mm; Diameter:10mm		5
I B-3	I bolt (NO.3)	Length:35mm; Diameter:10 mm		4
T E S	Tube send seal	Diameter:50mm; Thickness:2mm		14
TOOL	5# Tool (screw I Bolts)			1

Model CT-009

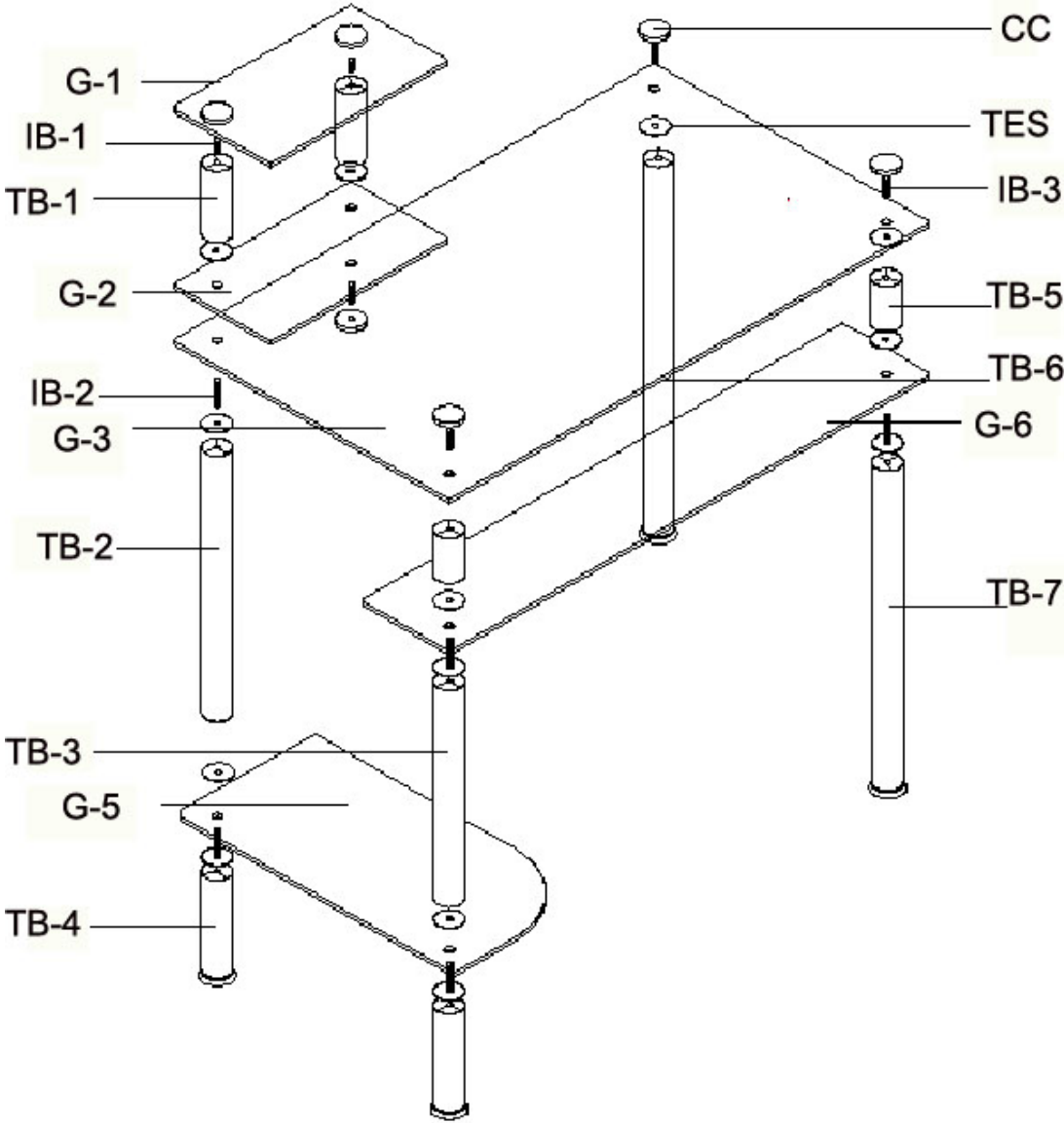

Model CT-009

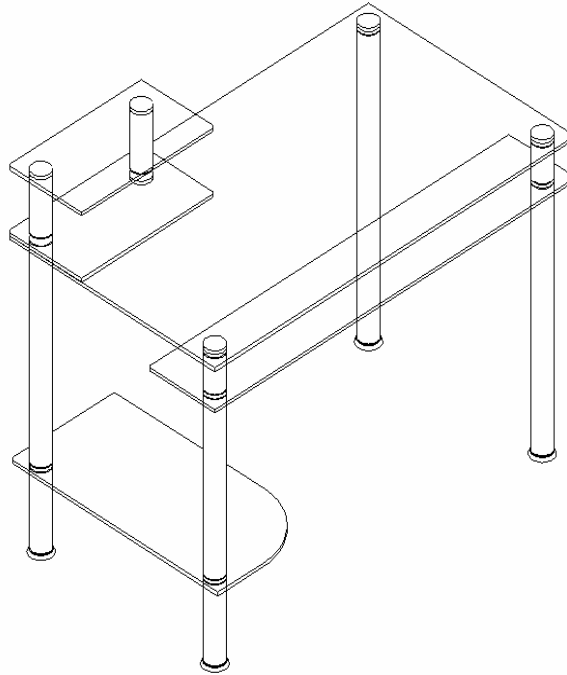

Stage 1

Please note stand is best assembled from the bottom up.

- 1.1 Screw in I bolts (I B-2) to the top of each tube (TB-4).
- 1.2 Place NO.5 Glass (G-5) in position over each foot tube leg with I bolts passing through holes in each corner of the shelf. Then screw tubes (TB-2 and TB-3) onto each exposed bolt until tight.
- 1.3 Screw in I bolts (I B-2) to the top of each tube (TB-3 and TB-7) and screw in I bolt (IB-3) to the top of tube (TB-6).

Stage 2

- 2.1 Place NO.4 Glass (G-4) in position over each tube leg with I bolts passing through holes in each corner of the shelf. Then screw tubes (TB-5) onto I bolts until tight.
- 2.2 Screw in I bolts (IB-3) to top of each tube (TB-5) and screw in I bolt (IB-2) to top of tube (TB-2).
- 2.3 Place NO.3 Glass (G-3) in position over each tube leg with I bolts passing through holes in each corner of the shelf.
- 2.4 Secure NO. 3 Glass with chrome caps on the three tubes (TB-5 and TB-6).

Stage 3

- 3.1 Screw in I bolts (IB-1) to the top of each tube (TB-1). Then screw the tubes to chrome caps on the NO.1 Glass (G-1).
- 3.2 Place NO.2 Glass resting on the NO.3 Glass. Then screw one of the tubes (TB-1) onto exposed bolt.
- 3.3 Screw in I bolt (IB-3) to the chrome cap. Then screw the chrome cap to another tube (TB-1).