

### FEATURED MODEL

440169 1-1/2 Bowl, 8" & 6-3/4" bowl depths

### ADDITIONAL MODELS

440167 1-1/2 Bowl, 10" & 6-3/4" bowl depths

440166 Reverse 1-1/2 Bowl, 6-3/4" & 10" bowl depths

440168 Reverse 1-1/2 Bowl, 6-3/4" & 8" bowl depths

### FEATURES

- Required outside cabinet: 36"
- 18 gauge, 304 series stainless steel
- Premium 18/10 chrome/nickel content
- Satin Polish finish
- Rear drain placement provides MAXIMUM flat space
- New design allows for easy installation in standard 25" countertop
- Sound deadening pads

### OPTIONAL ACCESSORIES

Stainless Steel Sink Grid Large: 220994

Stainless Steel Sink Grid Small: 220995

Colander: 510889

### CODE/STANDARDS COMPLIANCE

ASME 112.19.3-00

IAPMO/UPC listed

### WARRANTY

Blanco America's Stainless Steel sinks feature a LIMITED LIFETIME WARRANTY to be free of all manufacturing defects under normal use. See our complete warranty for details.

While Blanco America endeavors to provide accurate information, all dimensions are nominal, cannot be guaranteed, and are subject to change or cancellation. Blanco America assumes no responsibility for use of superseded or voided specifications.

### JOB INFORMATION

Job Name: \_\_\_\_\_

Contact: \_\_\_\_\_

Date Specified: \_\_\_\_\_

Specifier: \_\_\_\_\_

Contractor: \_\_\_\_\_



### NOMINAL DIMENSIONS

Model 440169 shown

OVERALL	CUT OUT SIZE	BOWL DEPTHS		DRAIN
		LEFT	RIGHT	
31-1/2" x 20-7/8"	Template provided with approximate 1/8" reveal	8"	6-3/4"	3-1/2"

DXF cutout templates available on our website.

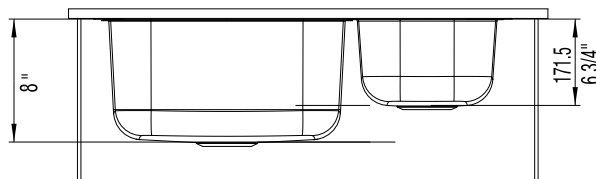
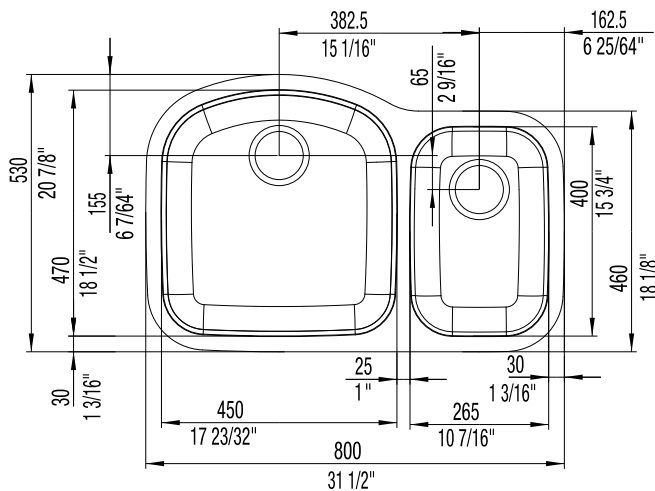

### BLANCO AMERICA

800.451.5782

www.blancoamerica.com

© 2013 BLANCO AMERICA

6/13

SPEC-003