

**SELECTRONIC®
HARD-WIRED AC POWERED PROXIMITY
TOILET FLUSH VALVE
1.1, 1.28, 1.6, 1.6/1.1 & 1.28/1.1**

PRODUCT NUMBERS

6067.111	6068.161
6067.721	6068.121
6067.761	6068.111
6067.121	6068.761
6067.161	6068.721

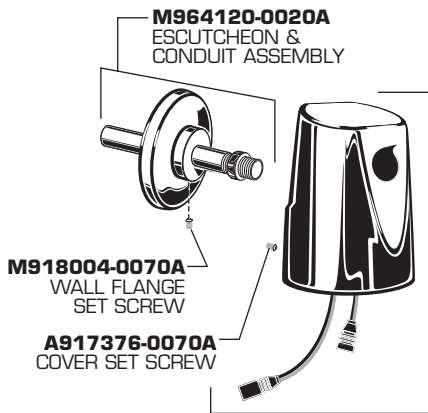

- M964892-0024000A**
COVER ASSEMBLY FOR
FLUSH VALVE WITH 1.6/1.1 gpf
- M964892-0025000A**
COVER ASSEMBLY FOR
FLUSH VALVE WITH 1.28/1.1 gpf
- M964892-0021600A**
COVER ASSEMBLY FOR
FLUSH VALVE WITH 1.6 gpf
- M964892-0021280A**
COVER ASSEMBLY FOR
FLUSH VALVE WITH 1.28 gpf
- M964892-0021100A**
COVER ASSEMBLY FOR
FLUSH VALVE WITH 1.1 gpf

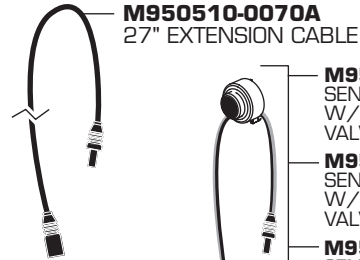
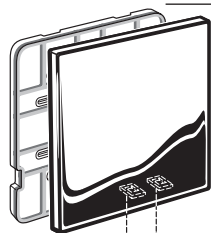

- M950319-0071600A**
SENSOR ASSEMBLY
W/MTG. KIT. FOR FLUSH
VALVE WITH 1.6 gpf
- M950319-0071280A**
SENSOR ASSEMBLY
W/MTG. KIT. FOR FLUSH
VALVE WITH 1.28 gpf
- M950319-0074000A**
SENSOR ASSEMBLY
W/MTG. KIT. FOR FLUSH
VALVE WITH 1.6/1.1gpf
- M950319-0075000A**
SENSOR ASSEMBLY
W/MTG. KIT. FOR FLUSH
VALVE WITH 1.28/1.1gpf
- M950319-0071100A**
SENSOR ASSEMBLY
W/MTG. KIT. FOR FLUSH
VALVE WITH 1.1gpf



- OPTIONAL ADJUSTABLE TAILPIECE
(Purchased Separately)
- M962836-0020A** (8-1/4" to 9-1/4" Rough-in)
- M962835-0020A** (7-1/4" to 8-1/4" Rough-in)
- M962834-0020A** (6-1/4" to 7-1/4" Rough-in)
- M962833-0020A** (5-1/4" to 6-1/4" Rough-in)

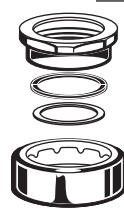
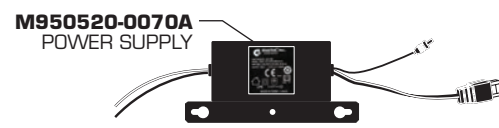
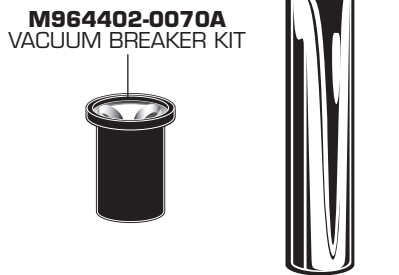
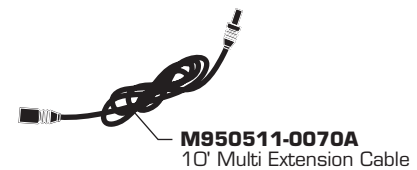
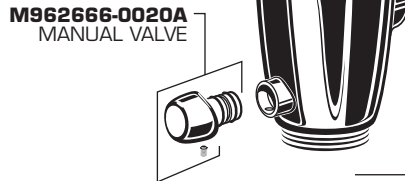

M952269-0020A
ESCUTCHEON KIT



HOT LINE FOR HELP
For toll-free information and answers to your questions, call:
1 (800) 442-1902
Weekdays 8:00 a.m. to 6:00 p.m. EST
IN MEXICO 01-800-839-12-00
IN CANADA 1-800-387-0369 (TORONTO 1-905-306-1093)
Weekdays 8:00 a.m. to 7:00 p.m. EST

Product names listed herein are trademarks of AS America, Inc.
© American Standard Inc. 2012