

R701 Shown

**MODEL NUMBER:**

- ☐ **R701 On/Off & Volume Control Valve**  
1/2" inlet/outlet. Less handle.
- ☐ **R711 On/Off & Volume Control Valve**  
3/4" inlet/outlet. Less handle.

**Model R701**

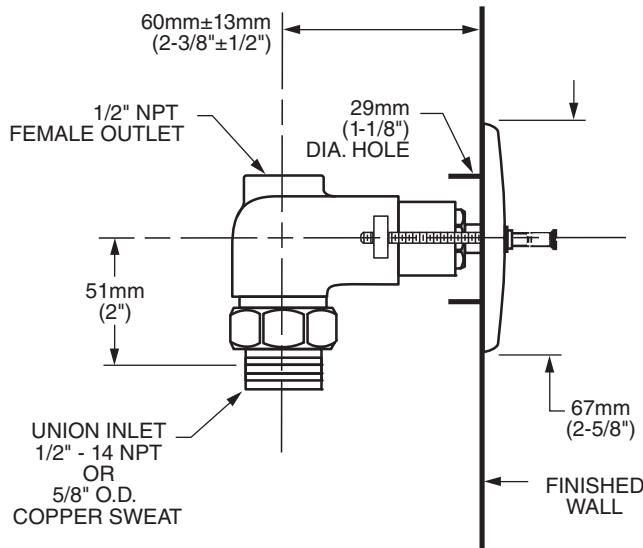

**Model R711**

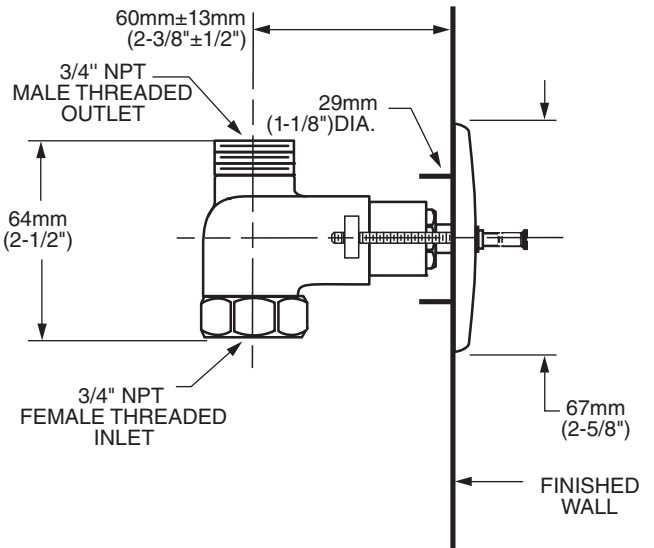

**GENERAL DESCRIPTION:**

Cast brass valve body. Washerless ceramic disc valve cartridge. Model R701 with combination 1/2" NPT threaded and direct sweat inlets. 1/2" NPT female outlet. Model R711 with 3/4" female inlet. 3/4" male outlet.

**PRODUCT FEATURES:**

**Brass Construction:** Durable - Excellent in high use applications. Ideal for prolonged contact with water.  
**Ceramic Disc Valve Cartridge:** Assures a lifetime of drip-free performance.

**SUGGESTED SPECIFICATION:**

In-wall single valve shall feature a cast brass valve body. Model R701 shall feature combination 1/2" NPT threaded and direct sweat inlets. 1/2" NPT female outlet. Model R711 shall feature 3/4" female inlet. 3/4" male outlet. Shall also feature 1/4 turn washerless ceramic disc valve cartridges. Fitting shall be American Standard Model # R7\_1.

**CODES AND STANDARDS**

These products meet or exceed the following codes and standards:

**ASME A112.18.1  
CSA B125.1**



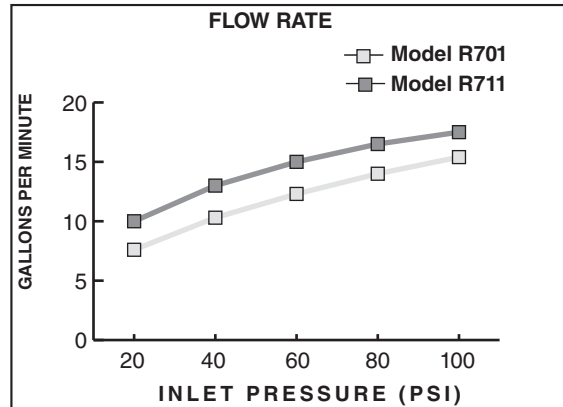















 Meets the American Disabilities Act Guidelines and **ANSI A117.1** Requirements for the physically challenged.



ROUGH VALVE BODIES	Product Number	Description
	R701*	In-wall single valve. 1/2" inlet/outlet. Less handle.
	R711*	In-wall single valve. 3/4" inlet/outlet. Less handle.

\* Trim and Handles must be ordered separately.

R701 and R711 will accept the following handles:

AVAILABLE TRIM KITS	Town Square®	Serin®	Green Tea®	Copeland™	Moments™	Times Square™
						
	T555.700 	T064.700 	T010.700 	T005.700 	T506.700 	T184.700 
Berwick®	Berwick®	Portsmouth®	Portsmouth®	Quentin™		
						
T430.700 	T430.702	T420.700 	T420.702	T440.700 