

## Saxton™ RT6-4GL

4 Hole Roman Tub Trim Kit  
Juego Para La Tina Romana De 4 Agujeros  
Baignoire Romaine Kit Garniture De 4 Trous

## Quick Installation Guide Guía de instalación rápida Guide d'installation rapide

Installation Support • Soporte de instalación • Support d'installation

### Personal Assistance, Product Specs, & "How-to" Questions:

Asistencia personal, especificaciones del producto y preguntas sobre "cómo hacerlo":

Aide personnelle, spécifications du produit et questions « pratique-pratiques » :

**1-800-PFAUCET (732-8238)**

**pfisterfaucets.com/support**

Installation Videos Available  
Videos de instalación a disposición  
Vidéos d'installation disponibles



pfisterfaucets.com/videos



### WARNING / AVERTENCIA / AVERTISSEMENT

To reduce the risk of injury or property damage, read all instructions before installing product. Wear safety goggles. Product must be installed in accordance with all state & local plumbing & building codes. Call a professional if you are uncertain about installing this product.

This product has been designed for use with the Pfister™ OX6-440R Roman Tub series rough-in. It will not work with any other product. For optimum performance of your roman tub, a minimum water pressure of 25 PSI (172 kPa) is recommended.

Para disminuir el riesgo de lesiones o daños a la propiedad, lea todas las instrucciones antes de instalar el producto. Utilice gafas de seguridad. El producto deberá instalarse de acuerdo con la normativa de plomería y construcción estatal y local. Llame a un profesional si no está seguro sobre cómo instalar este producto. Este producto ha sido diseñado para uso con la tubería empotrada para bañera romana OX6-440R de Pfister™. No trabajará con ningún otro producto. Para un desempeño óptimo de su bañera romana, se recomienda una presión de agua mínima de 25 PSI (172 kPa).

Pour réduire le risque de blessures ou de dommages, lire toutes les instructions avant d'installer l'appareil. Porter des lunettes de sécurité. Il faut installer l'appareil en respectant tous les codes de construction et de plomberie locaux et d'État. Appelez un professionnel si vous n'êtes pas certain de la façon d'installer cet appareil. Cet appareil a été conçu pour utiliser avec la plomberie brute Pfister série OX6-440R baignoire romaine. Il ne fonctionnera pas avec un autre appareil. Pour obtenir la performance optimale de votre baignoire romaine, une pression d'eau minimale de 25 PSI (172 kPa) est recommandée.

### Required Tools

#### Herramientas necesarias

#### Outils nécessaires



Adjustable Wrench  
Llave ajustable  
Clé à mollette



PTFE plumber's tape  
Cinta para plomería PTFE  
Ruban PTFE de plombier



Plumber's Putty  
Masilla para plomería  
Mastic de plombier



Safety Goggles  
Anteojos de seguridad  
Lunettes de sûreté

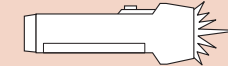

Flashlight  
Linterna  
Lampe de Poche

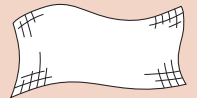

Cloth  
Paño de limpieza  
Chiffon

### Parts in the Box • Piezas en la caja • Contenu de la boîte

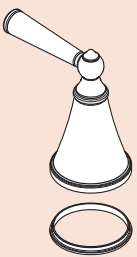

A (2X)

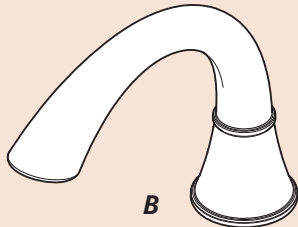

B



C

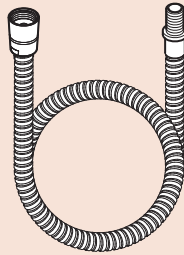

D

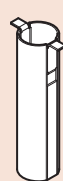

E



F



G



H



J

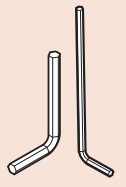

Hex Wrenches  
Llaves hexagonal  
Clés hexagonale

## 1 Turn Off Water Supply • Cierre el suministro de agua • Couper l'alimentation en eau

Locate the water supply inlets & shut off the water supply valves. These are usually found near the water meter. If you are replacing an existing unit, remove the old unit & clean mounting surface thoroughly.

Ubique las entradas del suministro de agua y cierre las válvulas de suministro. Estas se encuentran generalmente cerca del medidor de agua. Si reemplaza una unidad existente, retírela y limpie completamente la superficie de montaje.

Cherchez les entrées d'alimentation d'eau et fermez les robinets d'arrêt. Ils sont normalement trouvés près du compteur d'eau. Si vous remplacez un appareil existant, enlevez le vieil appareil et nettoyez soigneusement la surface de montage.

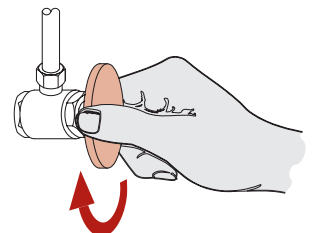

## 2 Prepare Rough-In & Set Up Stem Rotation

Prepare la tubería y configure la rotación del vástago  
Préparez la plomberie brute et réglez la rotation

### Spout Outlet Dimensions

Dimensiones del espacio del surtidor

Dimensions de espace de bec

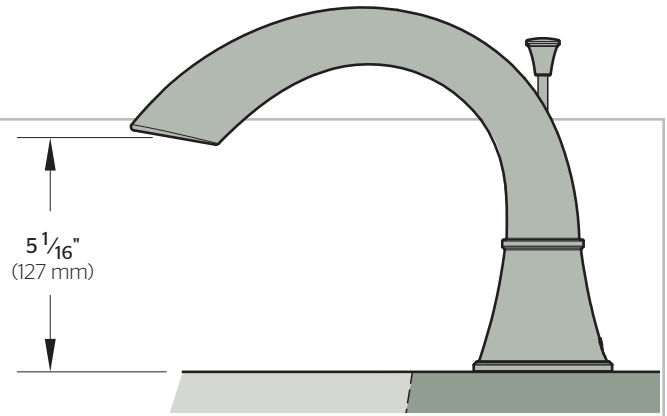

### 2A

#### Thin Surface Installation (1 3/8" Max) Instalación de una superficie delgada (35 mm) Installation sur une surface mince (35 mm)

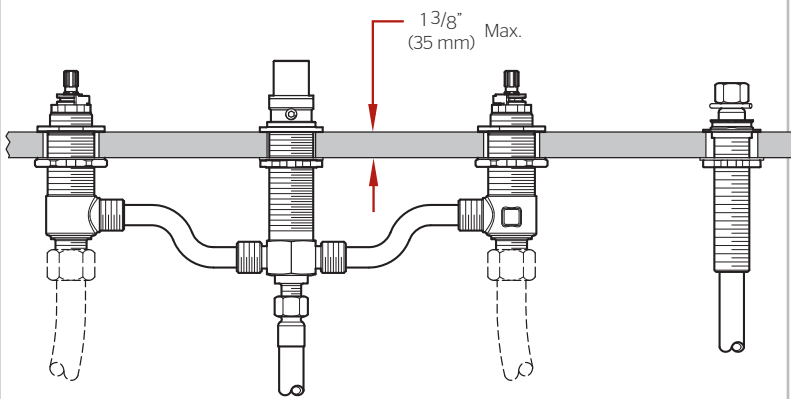

#### Thick Surface Installation (1 3/8" - 2 3/4" Max) Instalación de una superficie gruesa (41 mm - 70 mm) Installation sur une surface épaisse (41 mm - 70 mm)

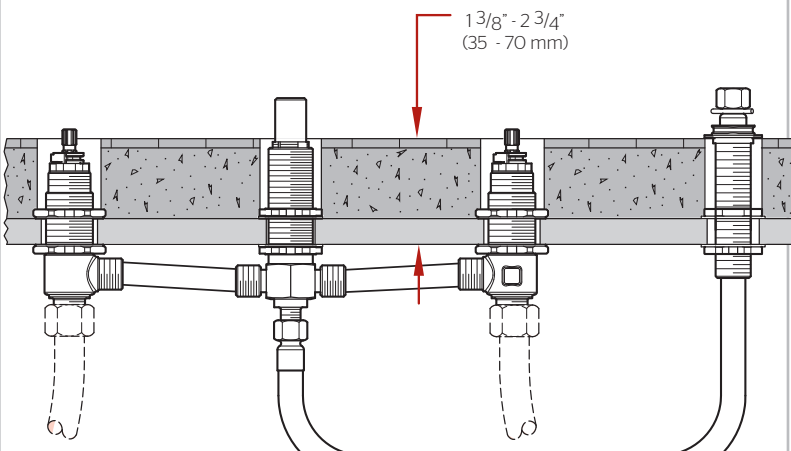

If deck thickness exceeds 1 3/8" (35 mm), Pfister™ Stem Extension Kit 974-375 must be used.

Si el grosor de la plataforma excede 1 3/8 pulg. (35 mm), se debe utilizar un juego de extensión del vástago 974-375 de Pfister™.

Si l'épaisseur du plateau de montage dépasse 1 3/8 po. (35 mm), il est nécessaire d'utiliser un kit de prolongement de tiges Pfister™ 974-375.

### 2B

#### Stem Rotation Set Up Determinación de la rotación de las espigas Rotation de la tige

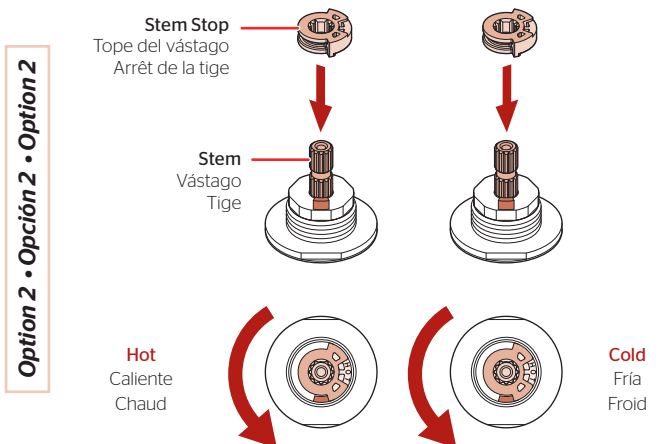
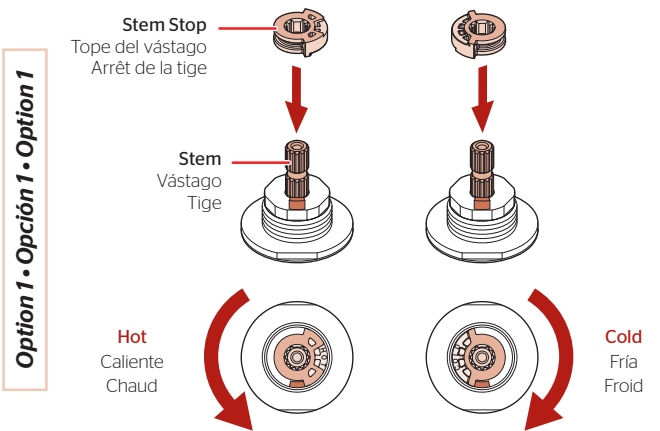

Stem Stop can be inserted into Stem in either of two ways, depending on the rotation you want to have for your handles.

El tope de la espiga puede ser insertado en la espiga en dos posiciones, dependiendo de la rotación que se quiera tener en los puños.

L'Arrêt De La Tige peut être introduit dans la tige de deux façons, selon la rotation que l'on veut obtenir pour les leviers.

### 3 Install Handle & Diverter

#### Instalación de la manija y el desviador

#### Installez la poignée et le mitigeur



Plumber's Putty  
Masilla para plomería  
Mastic de plombier

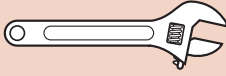

Adjustable Wrench  
Llave ajustable  
Clé réglable



Hex Wrench  
Llave hexagonal  
Clé hexagonale

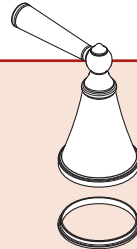

A (2X)



C



J

3A

#### Handle Installation

#### Instalación de la manija

#### Installez la poignée

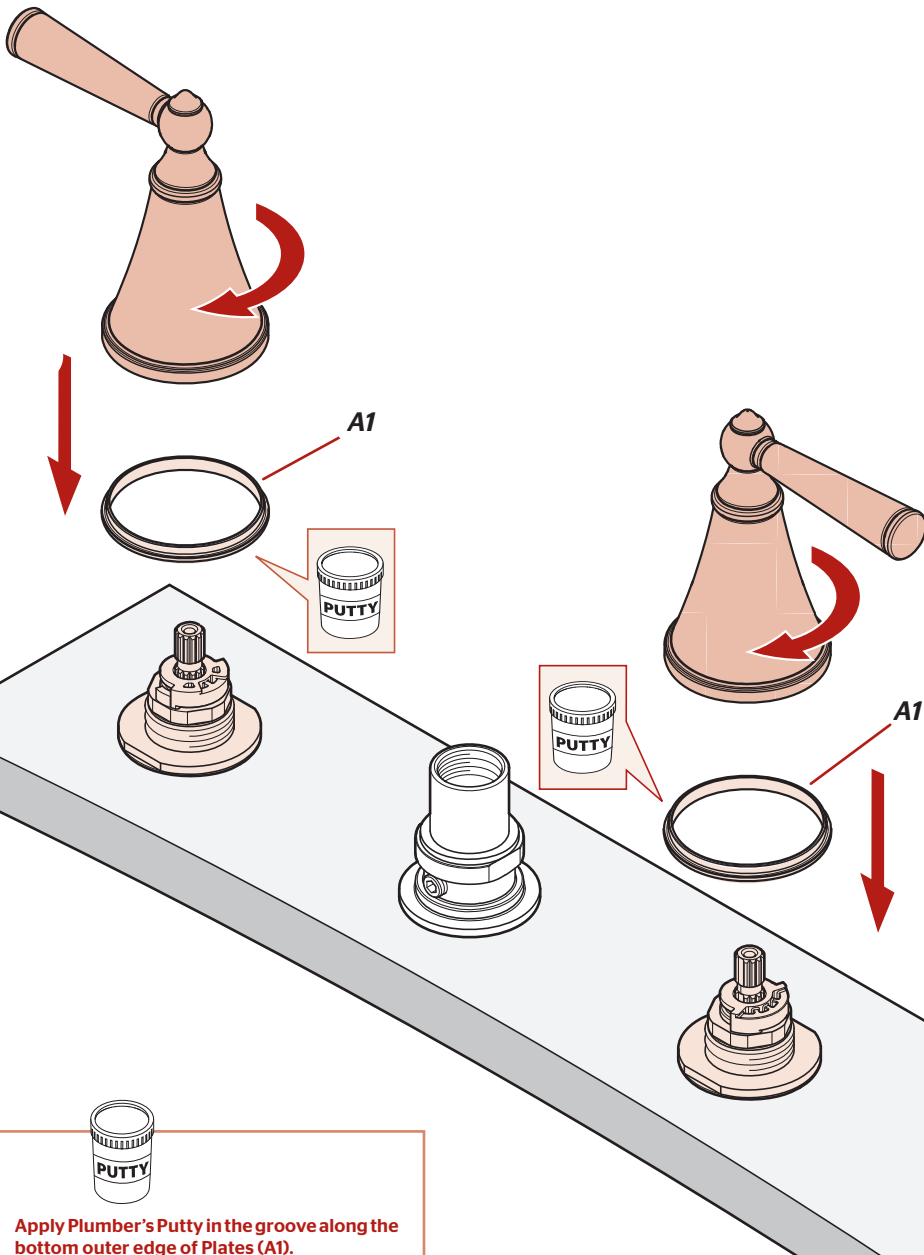

Apply Plumber's Putty in the groove along the bottom outer edge of Plates (A1).

Aplique masilla de plomería en la ranura a lo largo del borde exterior de la placa inferior (A1).

Appliquer le mastic de plombier dans la rainure prévue à cet effet sur la plaque inférieure (A1).

3B

#### Diverter Installation

#### Instalación de la manija y el desviador

#### Installez la poignée et le mitigeur

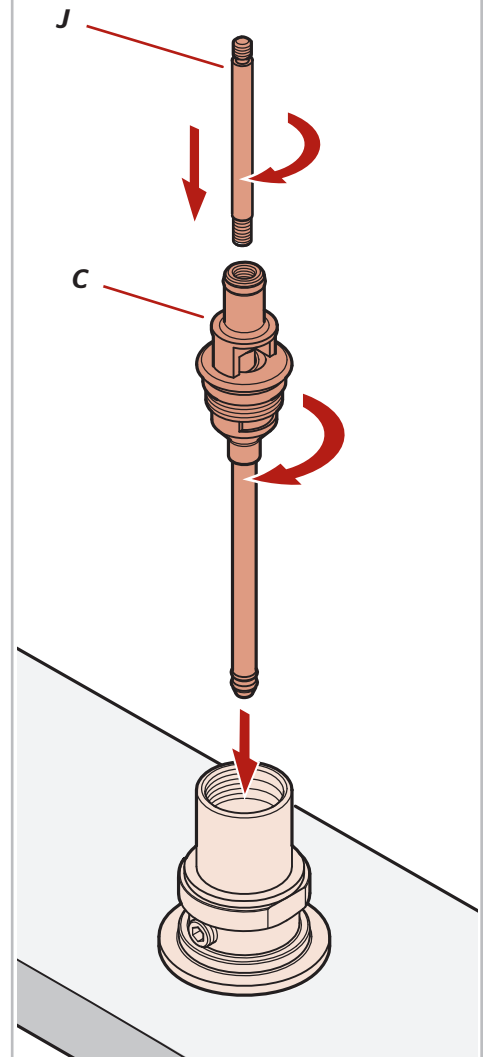

# 4

## Install Spout Instalación de el surtidor Installez le bec



Plumber's Putty  
Masilla para plomería  
Mastic de plombier



Hex Wrench  
Llave hexagonal  
Clé hexagonale

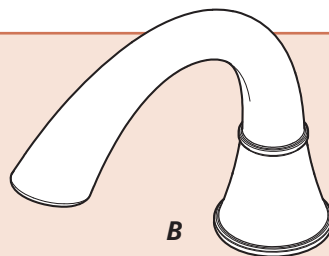

H

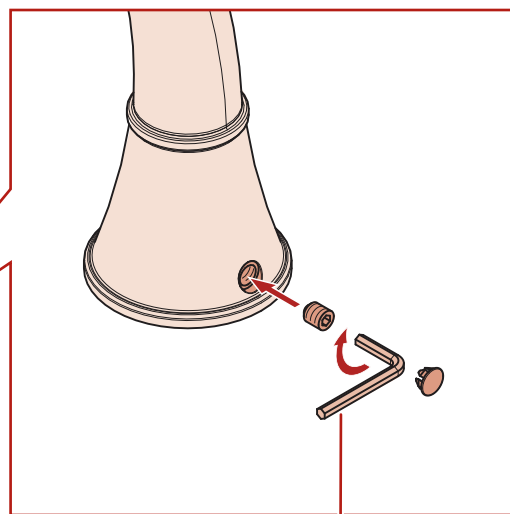
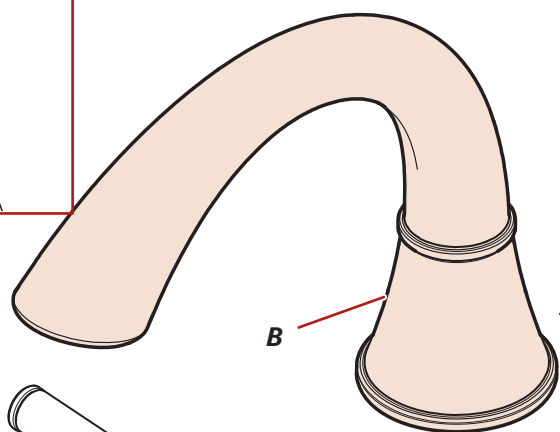
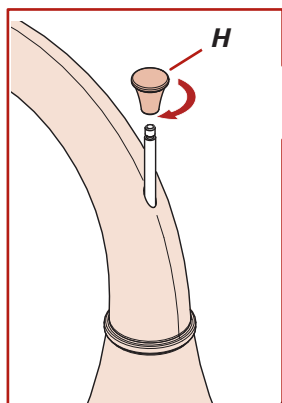

Hex Wrench  
Llave hexagonal  
Clé hexagonale

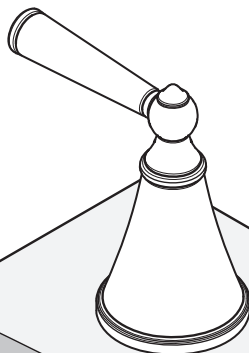

J

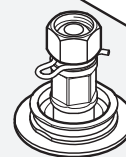
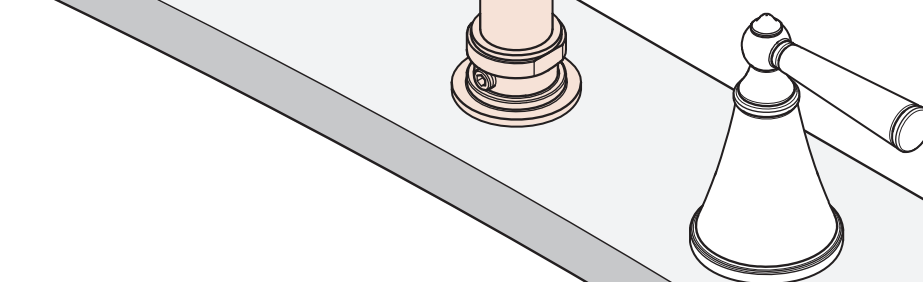
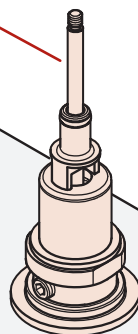

**Apply Plumber's Putty in the groove along the bottom outer edge of Plate (B).**

Aplique masilla de plomería en la ranura a lo largo del borde exterior de la placa inferior (B).

Appliquer le mastic de plombier dans la rainure au long du bord extérieur de la plaque (B).

# 5

## Install Hose Guide

### Instalación de la guía de la manguera

### Installez le guide du tuyau



Plumber's Putty  
Masilla para plomería  
Mastic de plombier



PTFE plumber's tape  
Cinta para plomería PTFE  
Ruban PTFE de plombier



Hex Wrench  
Llave hexagonal  
Clé hexagonale

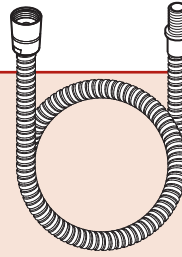

D



F

#### 5A

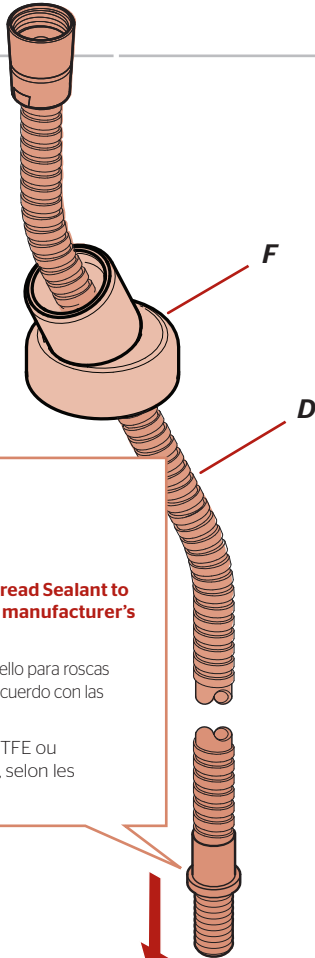

**Apply PTFE Plumber's Tape or Thread Sealant to all threaded fittings according to manufacturer's instructions.**

Aplique cinta para plomería de PTFE o sello para roscas en todos los adaptadores roscados de acuerdo con las instrucciones del fabricante.

Appliquez du ruban de plomberie PTFE ou du mastic à tous les raccords filetés, selon les recommandations du fabricant.

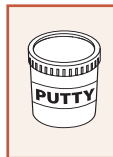

F1



#### 5B

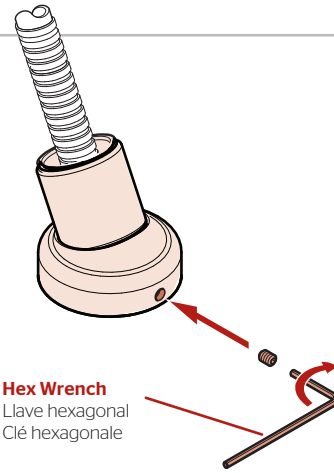

Hex Wrench  
Llave hexagonal  
Clé hexagonale

**Do not remove clip until hoses are securely tightened to each other.**

No quite el clip hasta que las mangueras se aprieten con seguridad el uno al otro.

N'enlevez pas l'agrafe jusqu'à ce que des tuyaux soient solidement serrés entre eux

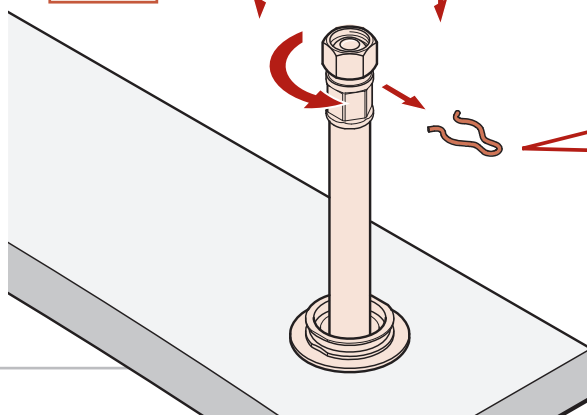

## 6 Turn On Water & Confirm Proper Installation

Active el suministro de agua y confirme que la instalación está adecuadamente efectuada

Ouvrez l'eau et confirmez que l'installation est adéquate

### 6A

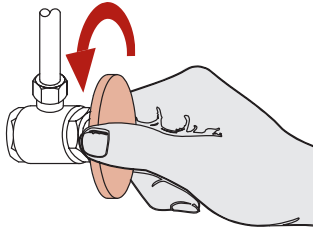

**Check for leaks above and below the tub.**

Revise si hay fugas encima y debajo de la tina.

Assurez-vous qu'il n'y a pas de fuite au dessus ou au dessous de la baignoire.

### 6B

**Faucet Functions • Funciones del grifo • Fonctions du robinet**

**Hot**  
Caliente  
Chaud

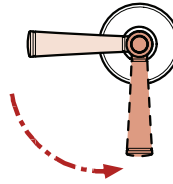

**Open**  
Abierta  
Ouvverte



**Cold**  
Fría  
Froid

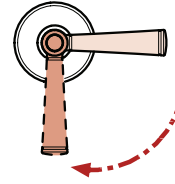

**Open**  
Abierta  
Ouvverte

## 7

### Flush the Faucet

Enjuague el grifo

Vidanger le robinet

### 7A

**Flush Spout**

Enjuague del surtidor

Rinçage du bec

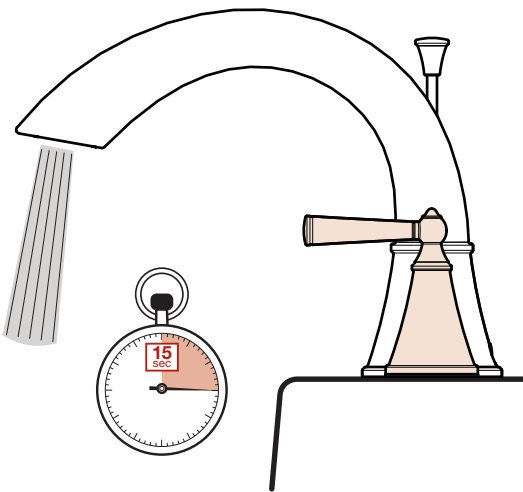

**Allow full hot & full cold water to run for at least 15 seconds each.**

Deje correr el agua caliente y fría durante al menos 15 segundos cada una.

Laissez couler de l'eau chaude et de l'eau froide pendant au moins 15 secondes chacune.

Permettez l'eau chaude ainsi que l'eau froide de couler pendant au moins 15 secondes.

### 7B

**Flush Hose**  
Enjuague  
Rinçage du tuyau

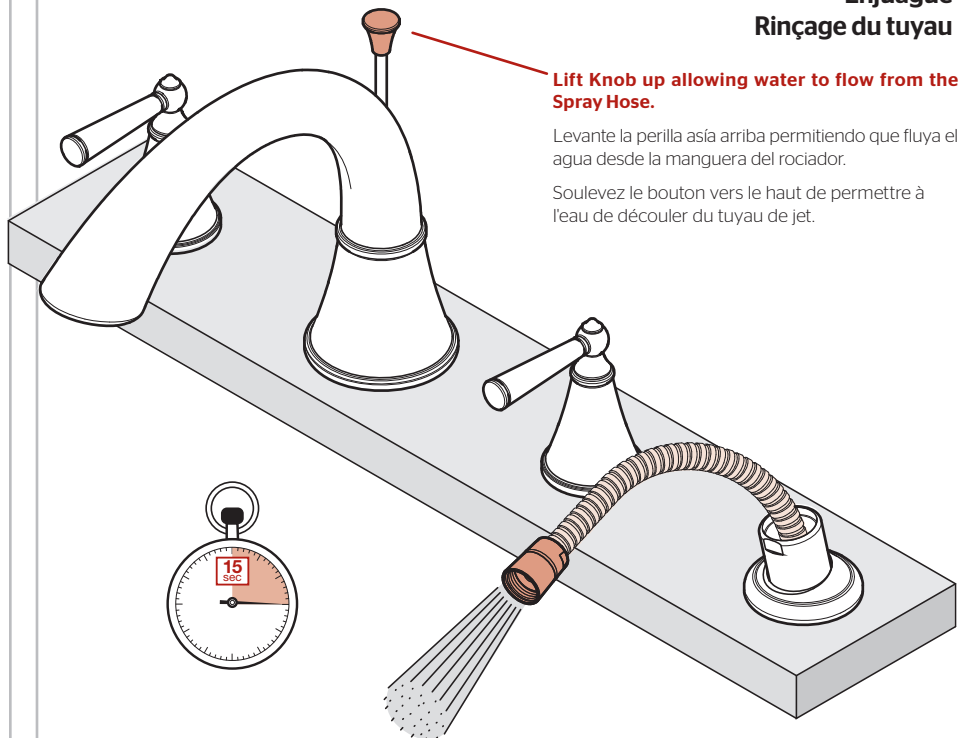

**Lift Knob up allowing water to flow from the Spray Hose.**

Levante la perilla así arriba permitiendo que fluya el agua desde la manguera del rociador.

Soulevez le bouton vers le haut de permettre à l'eau de découler du tuyau de jet.

**Allow hot & cold water to run for at least 15 seconds each.**

Deje correr el agua caliente y fría durante al menos 15 segundos cada una.

Laissez couler de l'eau chaude et de l'eau froide pendant au moins 15 secondes chacune.

# 8

## Install Hand Shower Instalación de la ducha de mano Installez la douche de main

No Tools Required for This Step  
No se necesitan herramientas para este paso  
Aucun outil nécessaire pour cette étape

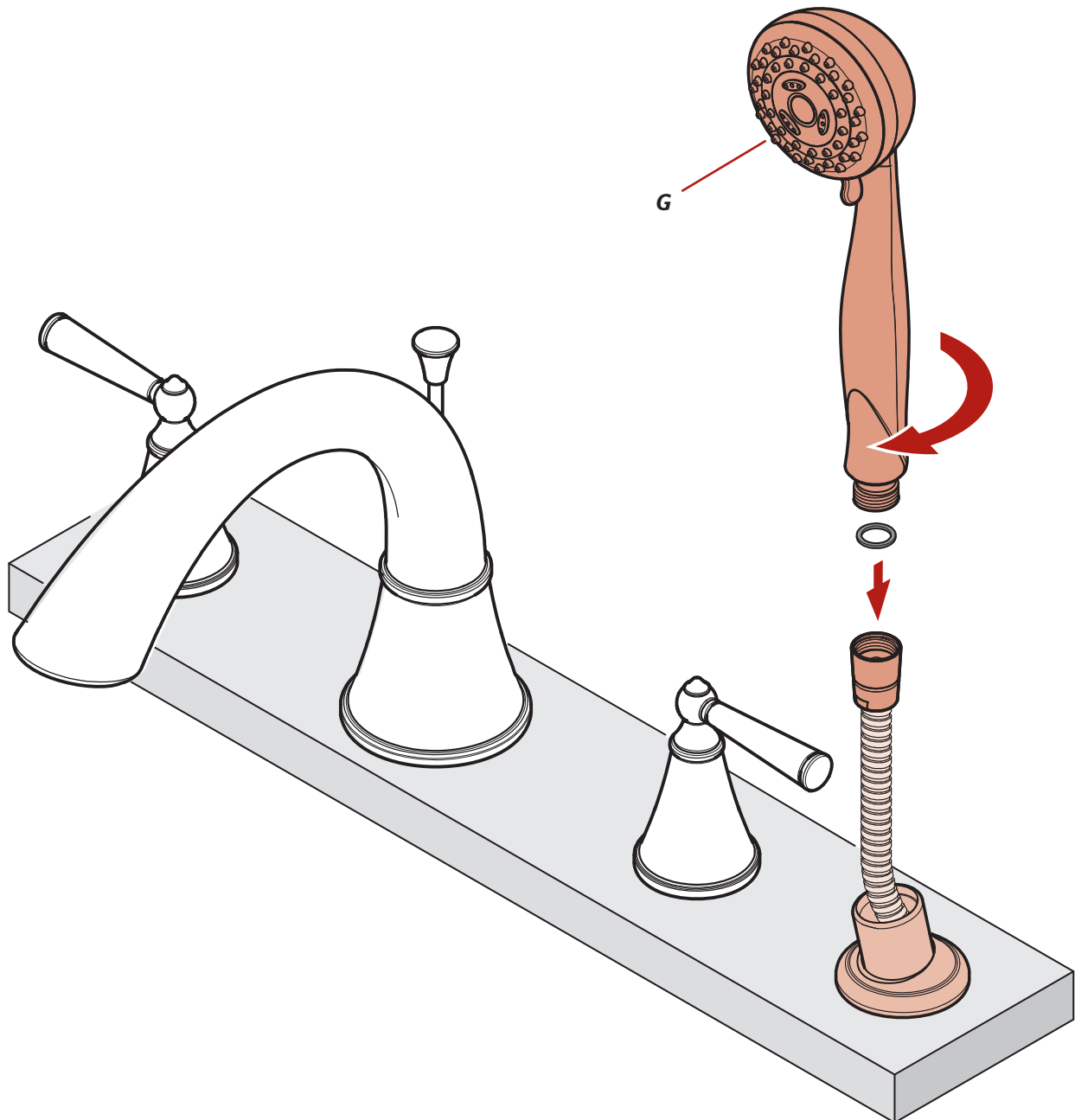

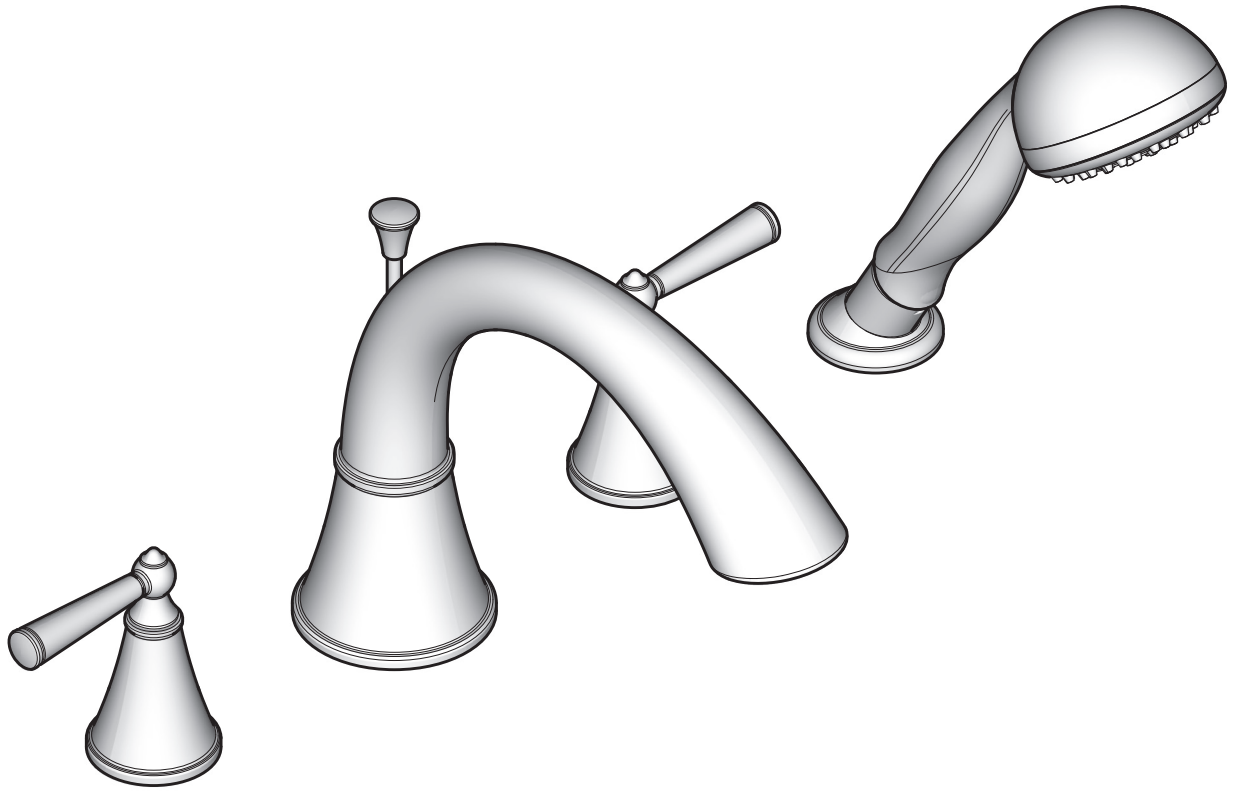

**For Additional Installation Help:**

Para la instalación adicionales de ayuda:  
Pour aider à l'installation supplémentaires:

**Pfister**

**1-800-PFAUCET (732-8238)**  
**[pfisterfaucets.com](http://pfisterfaucets.com)**