



GAZEBO PENGUIN INC.

4660 Hickmore, St-Laurent
Quebec, Canada H4T 1K2

1-800-737-7174 / 514-276-3485

Fax : 1-514-276-4147

adlonco@hotmail.com

436586 GRILL GAZEBO INSTALLATION MANUAL

**PLEASE, READ
BEFORE
INSTALLATION**

**PLEASE, READ
BEFORE
INSTALLATION**



Base Dimensions 6'10 1/2" x 4'11 1/4"; Largest Dimensions 7'10" x 4'11 1/4"

Before Assembly:

- Read instructions and check that all parts are present in the boxes. If any parts are missing, refer to warranty information on pg. 9.
- Assembly will require at least two persons and 2 hours.
- A stepladder will be required for assembly.
- The gazebo should be assembled on a level, flat surface.

Step 1:

Assemble each leg (A, B, C, D) onto base (E) using bolt (U), washer (U-2), and acorn nut (U-1). Each base can be installed in 4 directions, orient as required for your surface.

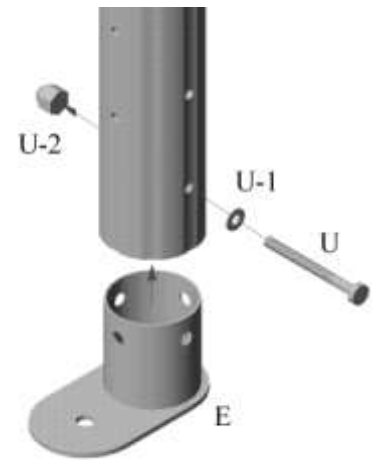

Step 2:

Assemble shelf support bar (F-1) under each top shelf (F) using 4 bolts (Bb) and locknuts (Aa-1) each. Attach one shelf between legs (A & C) using 4 bolts (X). Repeat with the second top shelf between legs (B & D).

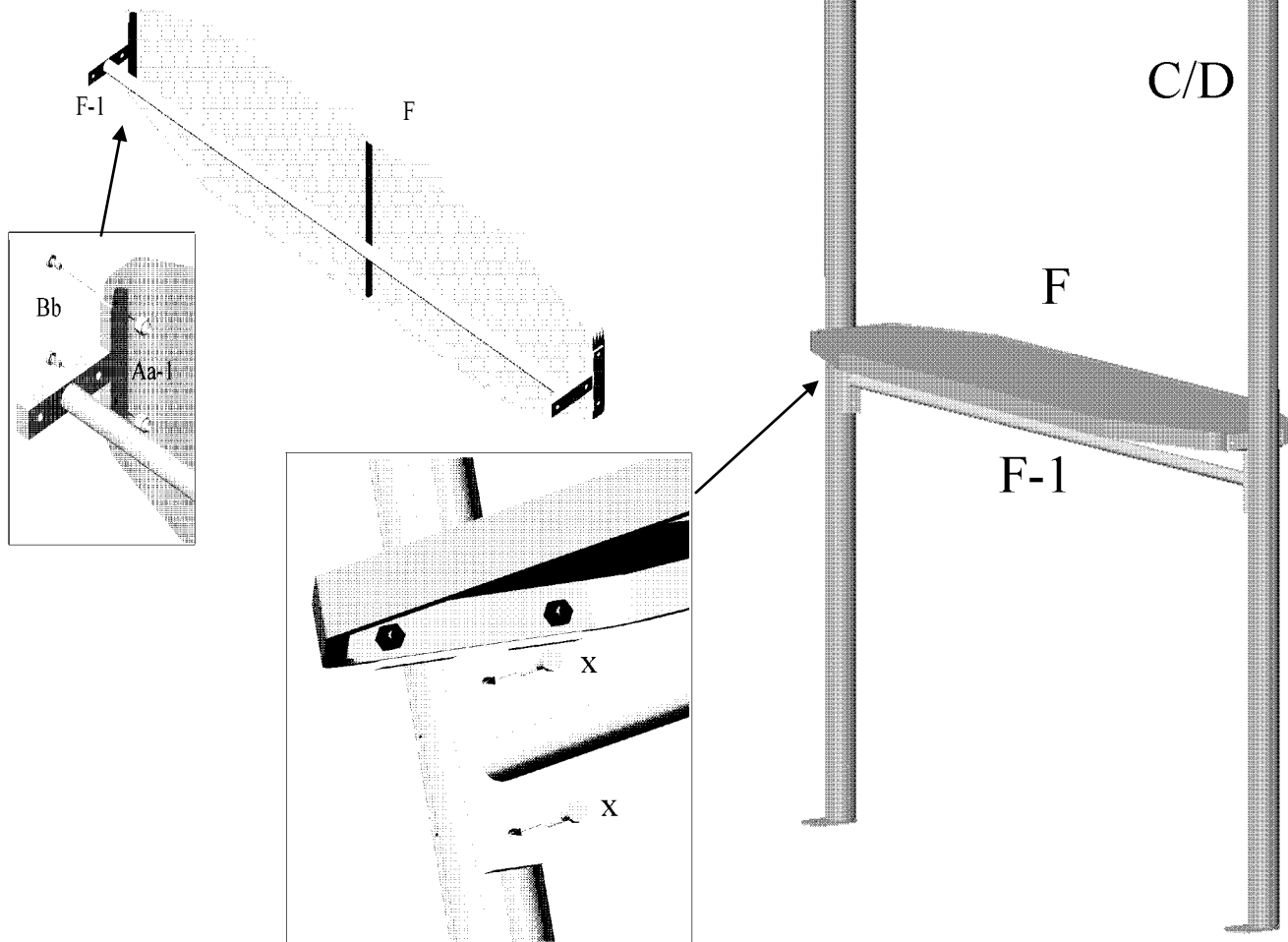

Step 3:

Attach the rear bars (G) between legs (A & B) using 2 bolts (Z) at each end. Then install the central bar (G-1) at the center of the two rear bars, using bolts (W).

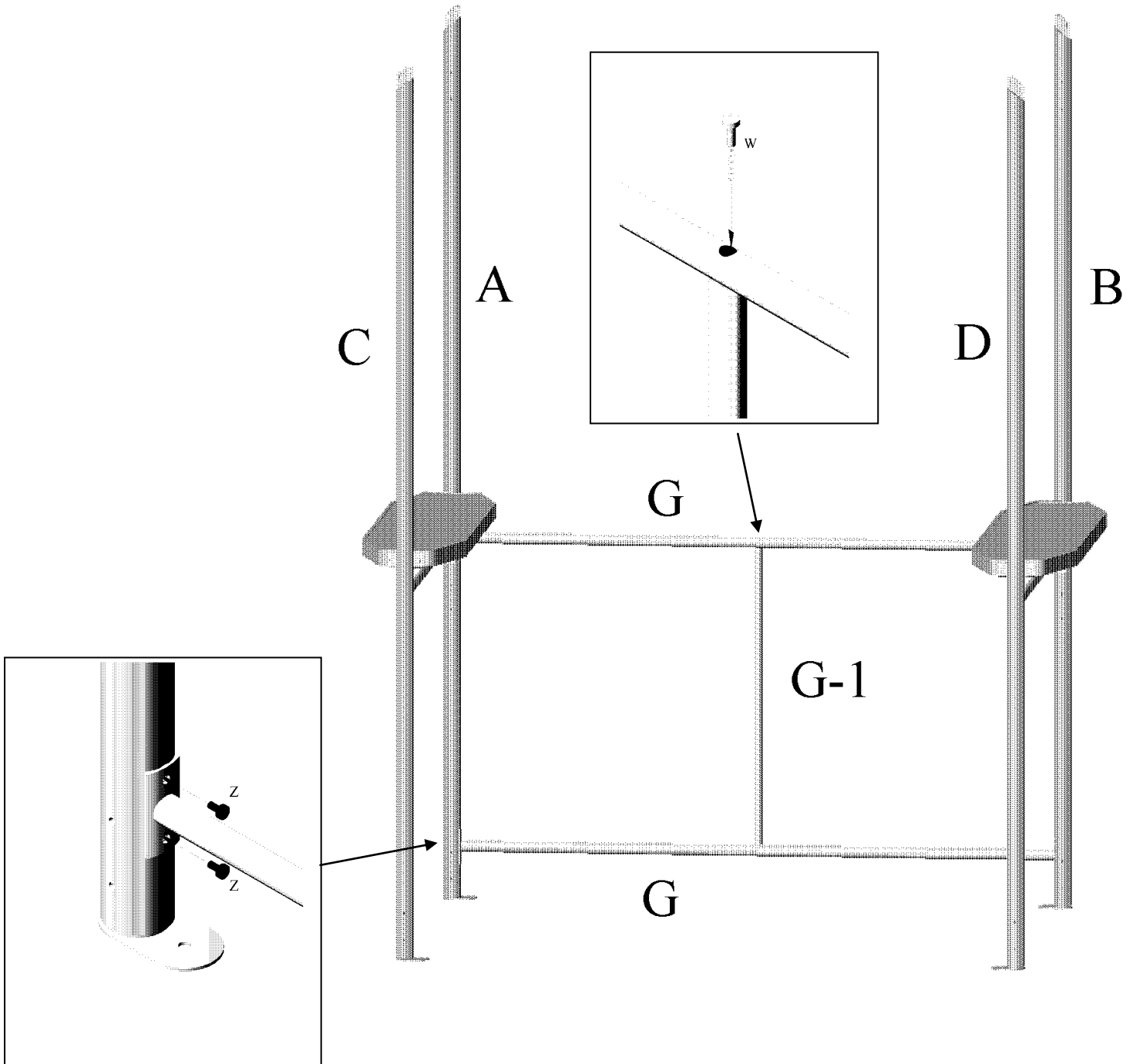

Step 4:

Attach the bottom side bars (H) at the bottom between legs (A & C) and (B & D) using bolts (U). Attach the top side bars (I) at the top between legs (A & C) and (B & D) using bolts (Z). Attach the top bars (J) between legs (A & B) and (C & D), again using bolts (Z).

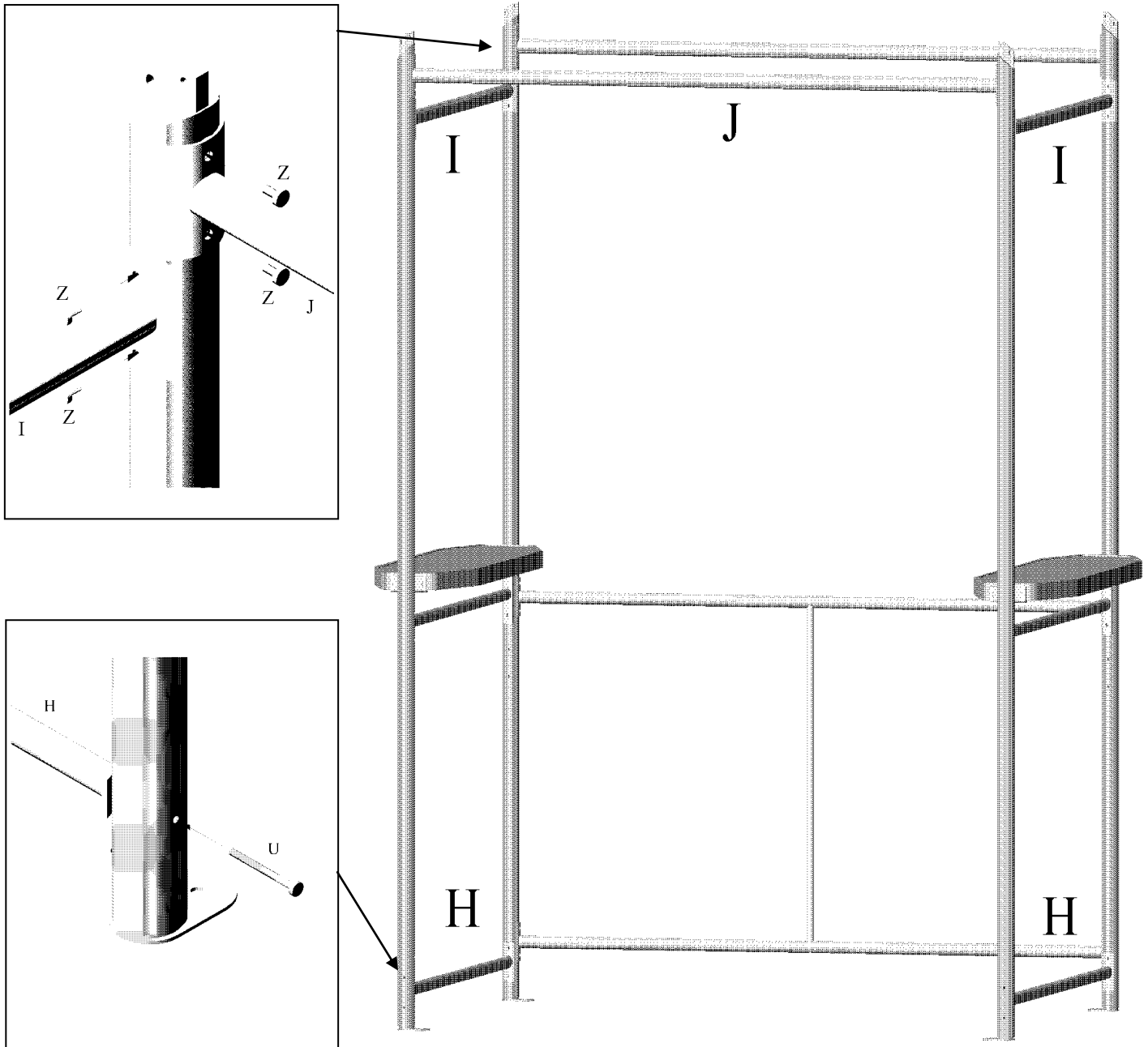

Step 5:

Screw shelf brackets (K-1) to the bottom of the shelf (K) on each side, using bolt (Aa) and locknut (Aa-1). Then attach the shelves and shelf brackets between the left legs (A & C) using bolts (Z). Screw cloth holder brackets (L-1 & L-2) to the cloth holder (L) using bolts (Z). Then attach them between the right legs (B & D), also using bolts (Z).

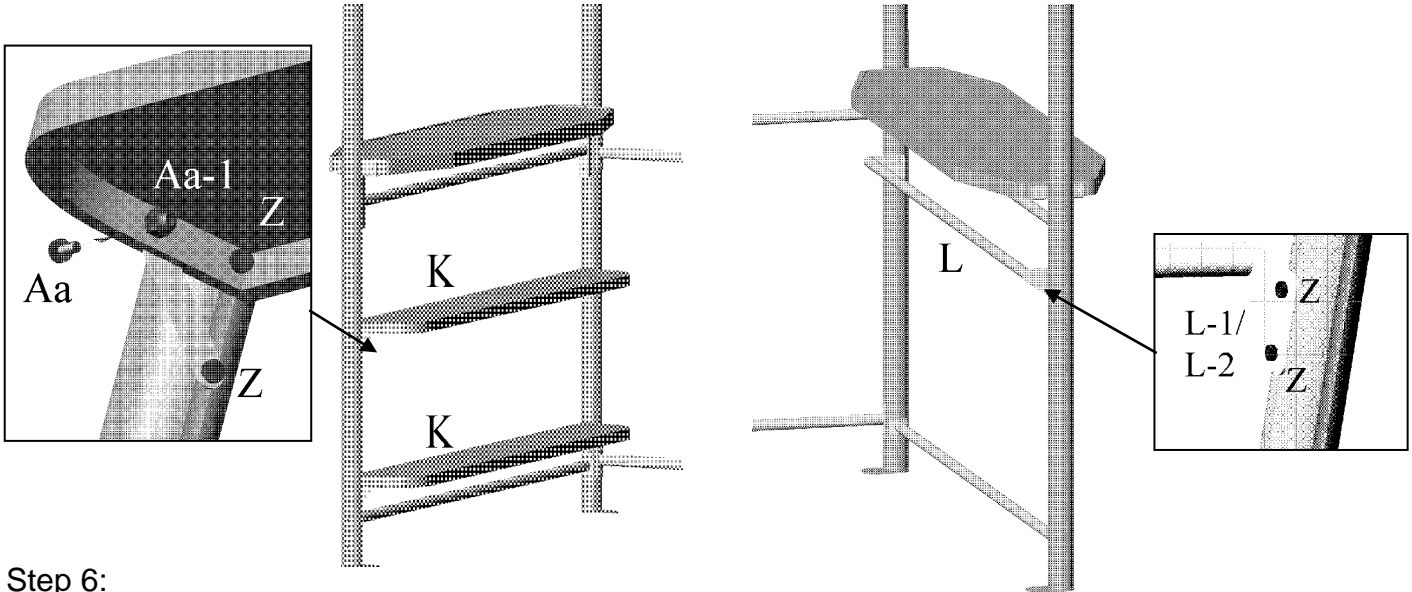

Step 6:

For the upper roof, lay out edge rafters (M & M-1), two edgings (O), roof panels (P), and rafters (Q), as shown in diagram. Attach rafter (M-1) and one edging (O) in one corner using a roof connector (R) and 4 bolts (Cc). Do the same with rafter (M) and the other edging (O) at the opposite corner.

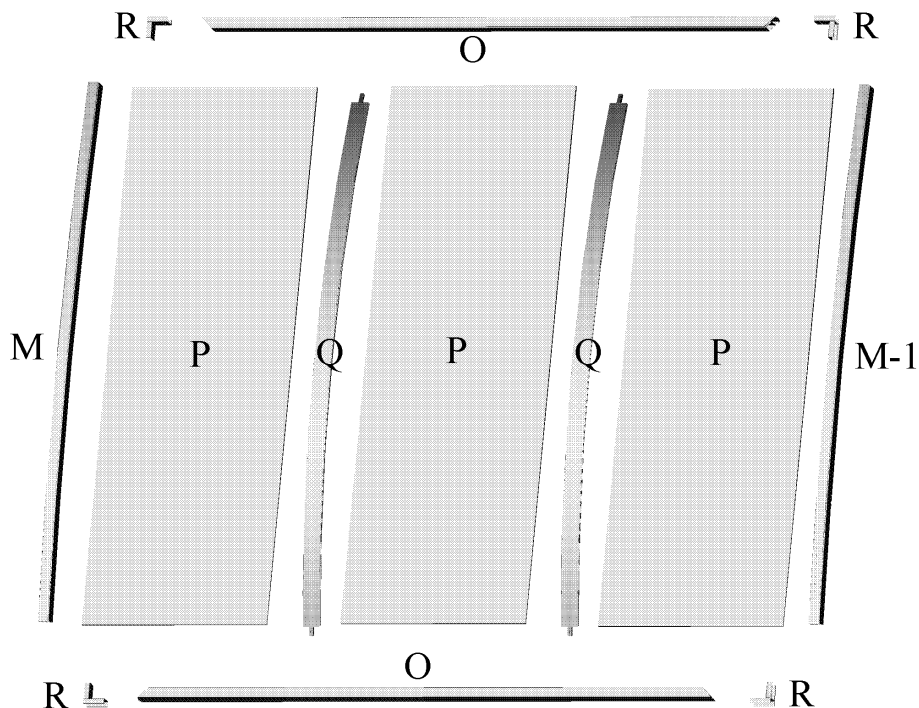

Step 7:

Bend and slide roof panel (P) into one corner, then insert rafter (Q) next to it, attaching the ends to the edging (O) with bolts (Cc). Add the next roof panel (P), then another rafter (Q) in the same manner. Insert the final roof panel (P), and then close the upper roof with the previously assembled corner (M & O), using roof connectors (R) at the corners and bolts (Cc).

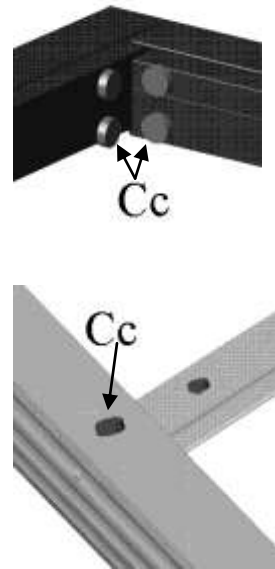

Step 8:

For the lower roof, lay out edge rafters (N & N-1), two edgings (O), roof panels (P-1), and rafters (Q-1), as shown in diagram. Then repeat steps 6 and 7 using these pieces to complete the lower roof.

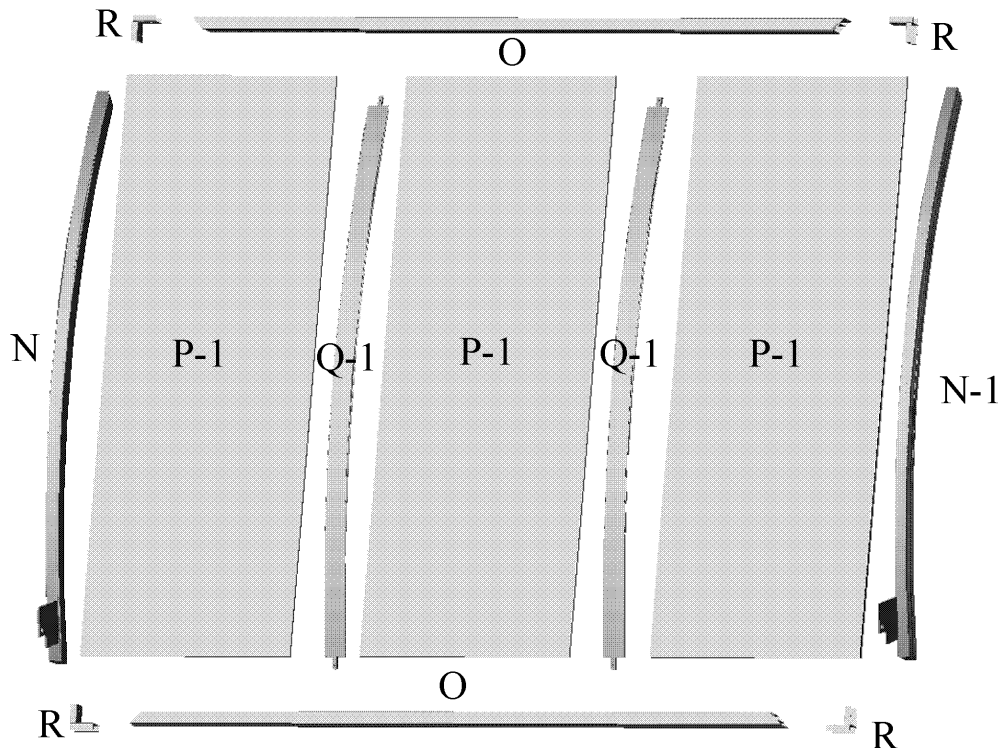

Step 9:

Attach roof supports (S) to the center of each top bar (J) using one bolt (V) each.

Attach the lower roof assembly to the roof supports (S) using bolts (W), and to the top of legs (B & D) using 2 bolts (Y) per leg.



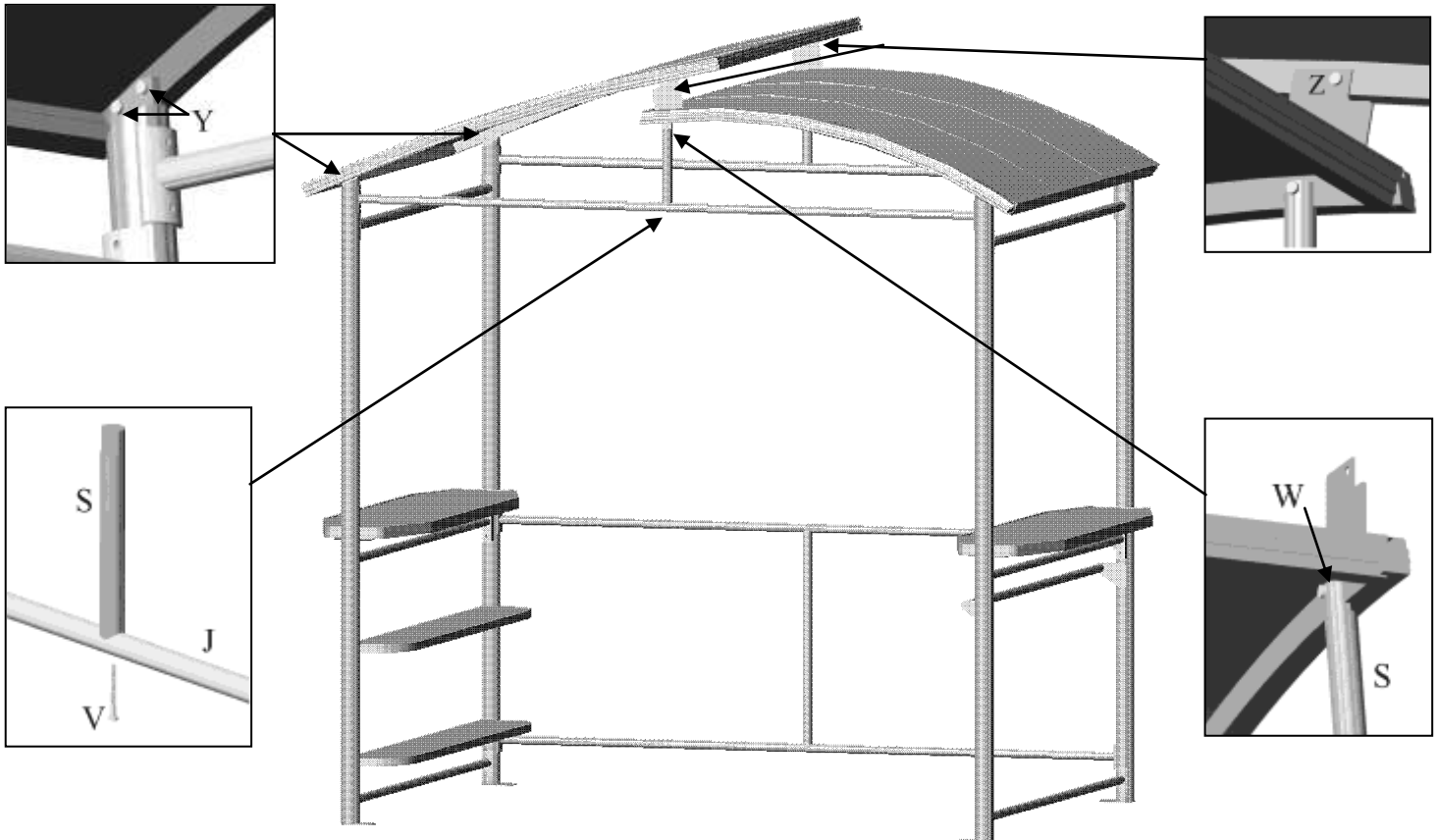





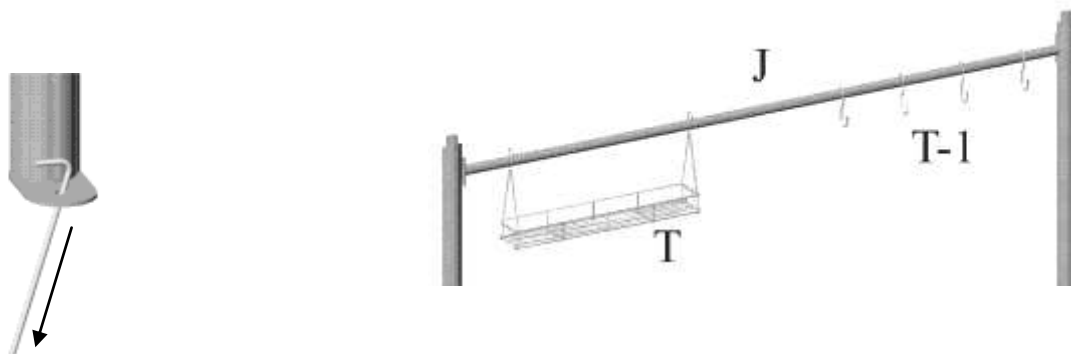













Attach the upper roof assembly to the plate on lower rafters (N & N-1) using bolts (Z), and to the top of legs (A & C) using 2 bolts (Y) per leg.











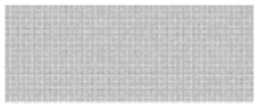

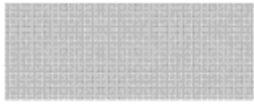











Step 10:

Anchor the unit to the ground through the bases (E). Use the provided nails (Dd), screws, and/or plugs as appropriate for your surface. If using nails, be sure to drive them in at an angle. Hang rack (T) and hooks (T-1) from the top bar (J) as preferred.



PART	QTY	DIAGRAM	PART	QTY	DIAGRAM
(12-051) BACK LEFT LEG A	1		(12-062) TOP BAR J	2	
(12-052) BACK RIGHT LEG B	1		(12-063) LOWER SHELF K	2	
(12-053) FRONT LEFT LEG C	1		(12-064) SHELF BRACKET K-1	4	
(12-054) FRONT RIGHT LEG D	1		(12-065) CLOTH HOLDER L	1	
(12-055) BASE E	4		(12-066) CLOTH HOLDER BRACKET L-1	1	
(12-056) TOP SHELF F	2		(12-067) CLOTH HOLDER BRACKET L-2	1	
(12-057) SHELF SUPPORT BAR F-1	2		(12-068) UPPER EDGE RAFTER M	1	
(12-058) REAR BAR G	2		(12-069) UPPER EDGE RAFTER M-1	1	
(12-059) CENTRAL BAR G-1	1		(12-070) LOWER EDGE RAFTER N	1	
(12-060) BOTTOM SIDE BAR H	2		(12-071) LOWER EDGE RAFTER N-1	1	
(12-061) TOP SIDE BAR I	2		(12-072) EDGING O	4	

PART	QTY	DIAGRAM	PART	QTY	DIAGRAM
P (12-073) UPPER ROOF PANEL 54 1/2" X 19" X 1/4"	3		(12-081) BOLT V	2	 M6x50mm
(12-074) LOWER ROOF PANEL P-1	3		(12-082) BOLT W	4	 M6x40mm
(12-075) UPPER RAFTER Q	2		(12-083) BOLT X	8	 M6x35mm
(12-076) LOWER RAFTER Q-1	2		(12-084) BOLT Y	8	 M6x30mm
(12-077) ROOF CONNECTOR R	8		(12-085) BOLT Z	40	 M6x20mm
(12-078) ROOF SUPPORT BAR S	2		(08-158) BOLT Aa	4	 M6x16mm
(12-079) RACK T	1		(12-086) LOCKNUT Aa-1	12	
(12-080) HOOK T-1	4		(08-168) BOLT Bb	8	 M6x12mm
(08-161) BOLT U	8	 M6x70mm	(12-087) BOLT Cc	40	 M5x8mm
(12-089) ACORN NUT U-1	4		(12-036) PHILLIPS #2 SCREWDRIVER	1	
(08-187) WASHER U-2	4		(12-088) NAIL Dd	4	

MAINTENANCE NOTES

1. In case of a defective or damaged part, or for any other questions concerning the product, please contact the manufacturer directly.
2. Please have the parts list and part numbers on hand when ordering or requesting replacement parts.
3. When cleaning, use mild soap or detergent, warm water, and a washcloth or sponge.
4. While the product is designed for 4 seasons use, it is strongly recommended to clear snow from the roof on a regular basis.

ONE YEAR LIMITED WARRANTY

This product has been designed and manufactured to meet the highest standards of quality and durability. Subject to the Conditions for Exercising the Warranty and the Limitations on the Warranty set forth below, it is warranted to be free of material and manufacturing defects for a period of **one year** from the date of purchase. Should the product become damaged, or the warranty period has expired, please contact Gazebo Penguin Customer Service Department for a complete schedule of replacement parts and prices.

CONDITIONS FOR EXERCISING THE WARRANTY

In order to properly exercise your warranty, please comply with the following:

Carefully inspect the contents of the carton for missing or damaged components. Should you discover damaged or missing parts, **do not return the product to the place of purchase**, but contact Gazebo Penguin Customer Service Department at the numbers listed below:

Montreal: (514) 276-3485

Elsewhere: 1-800-737-7174

LIMITATIONS ON THE WARRANTY

1. The product is not warranted against damages due to vandalism, abuse, or falling or thrown objects.
2. The product is not warranted against damages due to extreme weather conditions, such as thunderstorms, hail, or strong wind or snow storms.
3. The product is only warranted in the event it is installed in accordance with the Gazebo Penguin's written instructions enclosed with the product.
4. The product is not warranted in the event it has been improperly anchored.