

Tulip Wall

HW3783_2H75

1.7



Wall Sconces

GENERAL PRODUCT INFORMATION:



This product can mount to either a 4" square electrical box with round plaster ring or an octagon electrical box.

This product is suitable for indoor dry locations only.

This product can be dimmed with a standard incandescent dimmer.

CAUTION - RISK OF FIRE
 This product requires installation by a qualified electrician. Before installing be sure to read all instructions and **TURN THE POWER TO THE ELECTRICAL BOX OFF.**

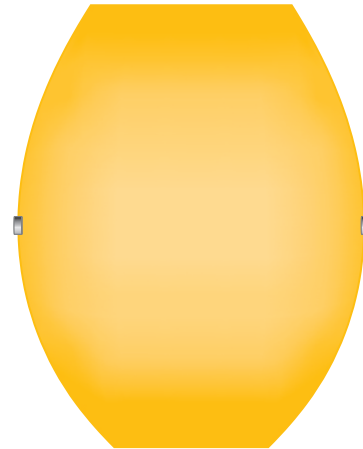

Install the Fixture

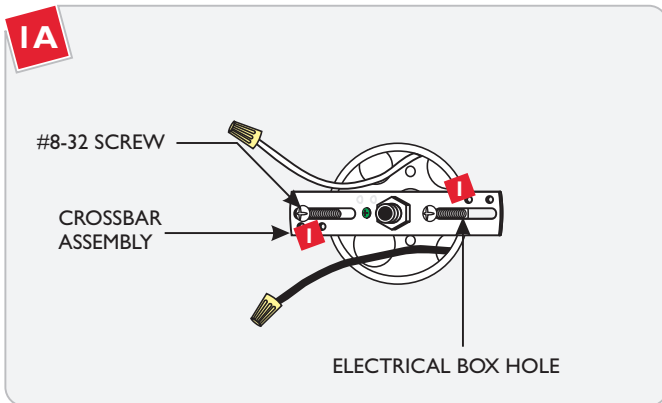

- 1** Mount the crossbar assembly to the electrical box holes with the two #8-32 screws provided.

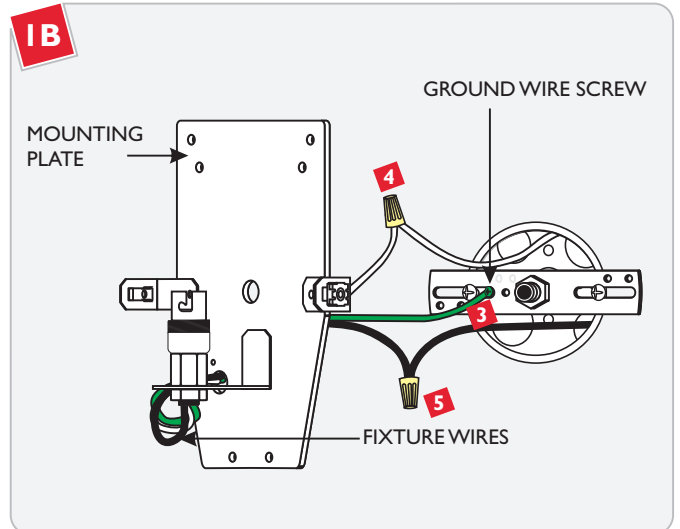

- 2** Feed the fixture wires through the mounting plate side hole.
- 3** Connect the ground wire (bare wire) to the crossbar green screw. Make sure that the crossbar is grounded in accordance with local electrical codes.
- 4** Connect the fixture white wire to the neutral power line wire with a wire nut.
- 5** Connect the fixture black wire to the hot power line wire with a wire nut.

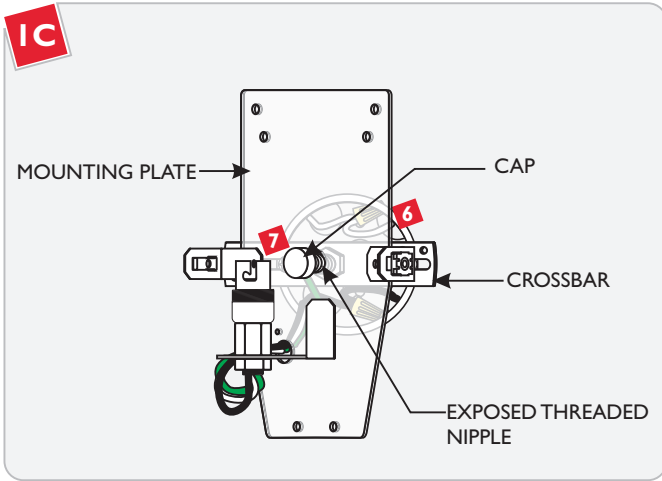

- 6** Place all wires and wire nut connections properly inside the electrical box.
- 7** Slide the mounting plate center hole onto the exposed threaded nipple. Secure the mounting plate in place by tightening the cap to threaded nipple.

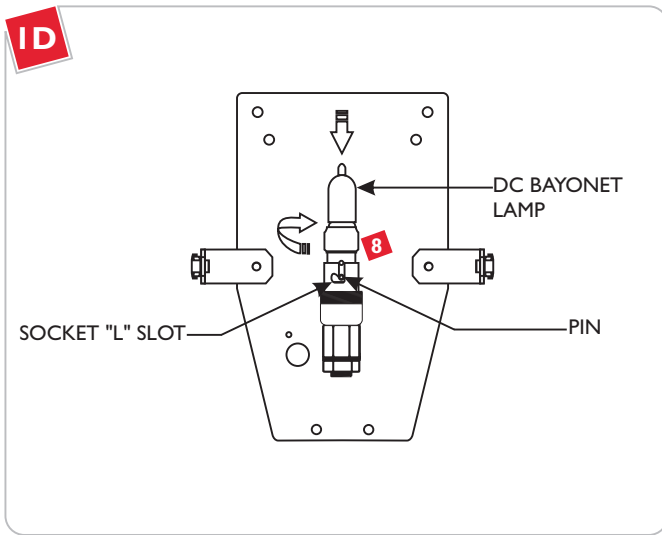

NOTE: Use only your fingers and a soft cloth to install the lamp.

Use **MAX** 120 Volt, **75** Watt Type DC Bayonet, BA15d Base Lamp.



- 8** Align the pins on the DC Bayonet lamp with the socket "L" slots. Push the lamp completely into the socket and rotate it clockwise to lock it in place.

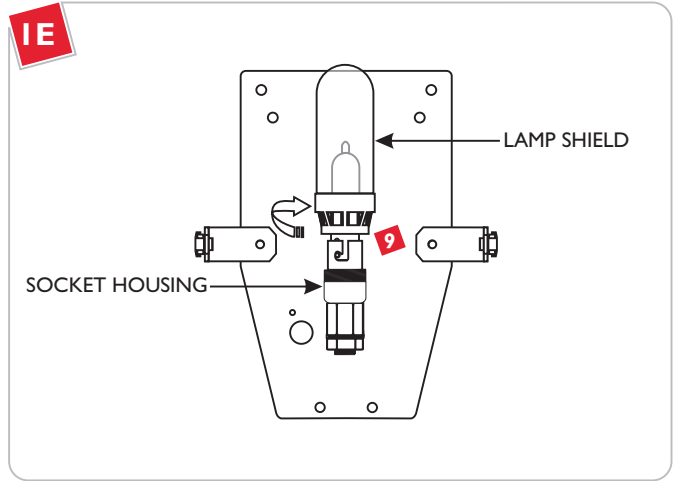

- 9** Place the lamp shield onto the socket housing. Screw **(Do Not Tighten)** the lamp shield onto the socket housing just enough (a couple of threads) to secure it in place.

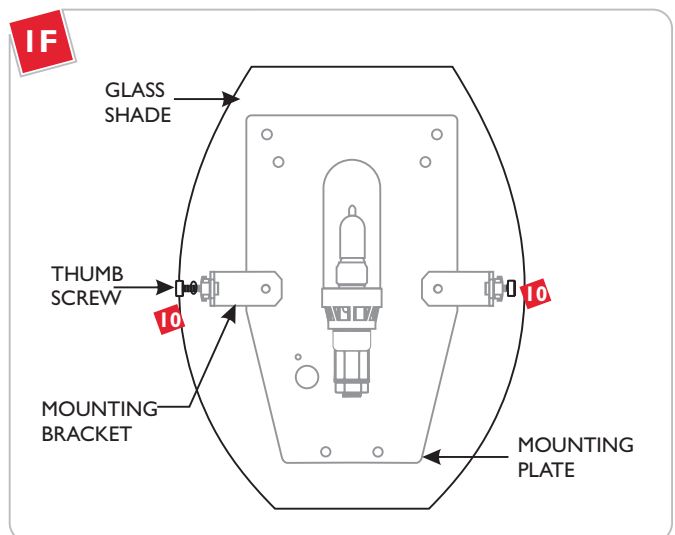

- 10** Place the glass shade onto the mounting plate. Align the glass shade holes with the mounting plate holes. Tighten the thumb screws to secure the glass shade in place.

NOTE: Do not over tighten the thumb screws which may cause the glass shade to break.

IMPORTANT SAFETY INSTRUCTIONS

To reduce the risk of fire, electrical shock, exposure to excessive UV radiation, or injury to person:

- Use this fixture indoors only.
- Do not look directly at the lighted lamp.
- Do not remain in light if skin feels warm.
- Risk of fire: Use only the type of lamp and maximum wattage indicated in this instruction manual.
- Never cover the halogen lamp with anything other than a LBL Lighting lamp shield and never place flammable material close to your fixture.
- Never turn the fixture on and off by connecting and disconnecting the halogen lamp.
- Do not touch the fixture shades or lamp shield while the fixture is on. These surfaces may be HOT.

Halogen Lamp General Information

- A new halogen lamp may smoke slightly when it is used for the first time. This is perfectly normal; the protective coating is simply being vaporized.

Two Tips For Prolonging Halogen Lamp Life

- First avoid touching the lamp with bare hands during installation. Any contaminant, even the oil from your hands can deteriorate the lamp. Rubbing alcohol can be used to remove any contaminant.
- Second, do not run the lamps at full power when you do not need to. However, if dimming the fixture for an extended period of time, occasionally bring the light up to full brightness for a few minutes to complete the halogen cycle.

SAVE THESE INSTRUCTIONS!



7400 Linder Ave, Skokie, IL 60077

800.323.3226 - 847.626.6300

www.lblighting.com

© 2008 LBL Lighting. All rights reserved. The "LBL Lighting" graphic is a registered trademark of LBL Lighting. LBL Lighting reserves the right to change specifications for product improvements without notification.

A Generation Brands Company