

Nikko (18 Watt Compact Fluorescent)

148_HE, 149_HE, 159_HE | 1.0



Outdoor

GENERAL PRODUCT INFORMATION:

This product is suitable for wet locations.

This instruction shows a typical installation.

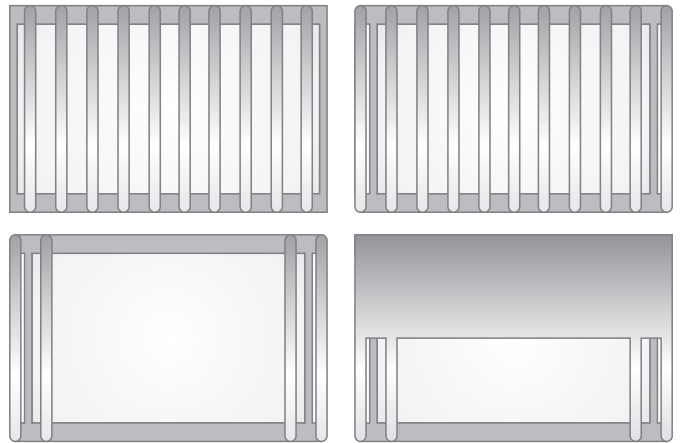

CAUTION - RISK OF FIRE
This product requires installation by a qualified electrician. Before installing be sure to read all instructions and **DISCONNECT POWER TO THE ELECTRICAL BOX.**

Install the Fixture

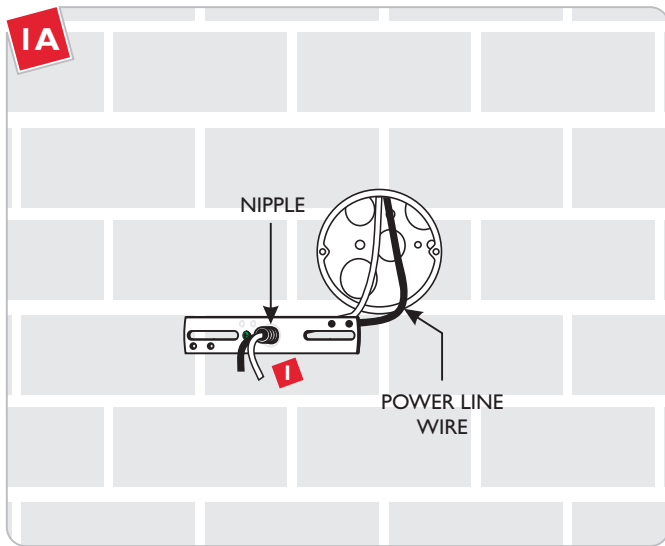

1 Feed the power line wires through the crossbar nipple.

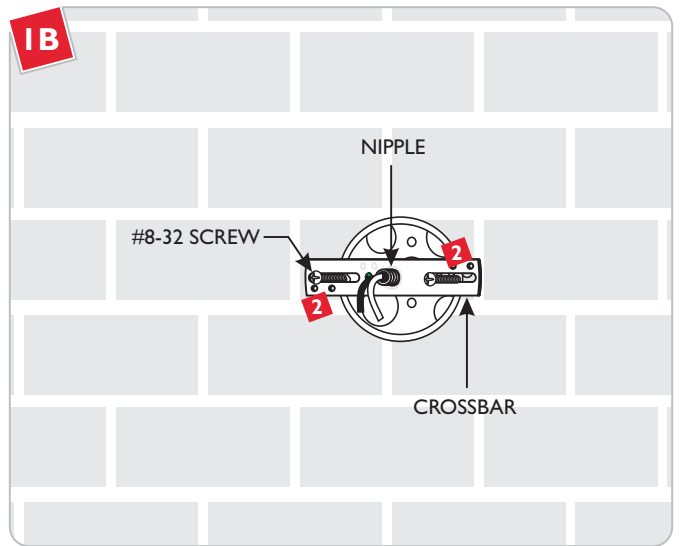

2 Attach the crossbar to the electrical box using two #8-32 screws provided.

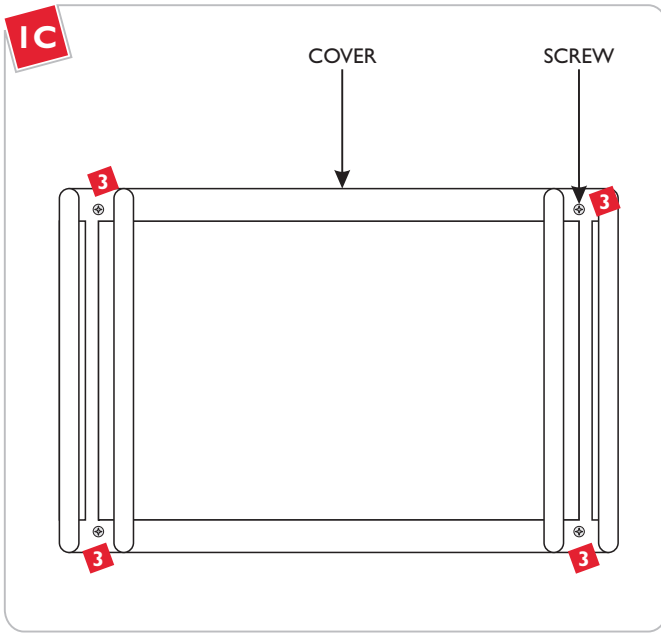

- 3** Remove all the screws from the front of the fixture.
- 4** Lift the cover off of the fixture.

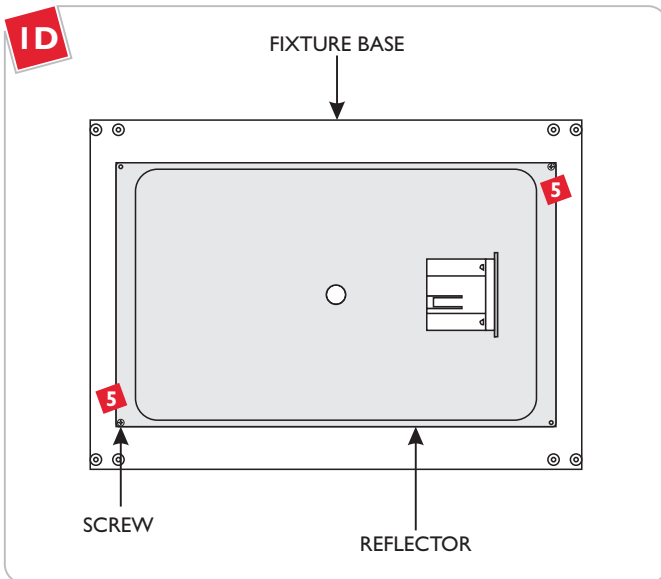

- 5** Remove the screws on the reflector.
- 6** Lift the reflector out of the fixture base.

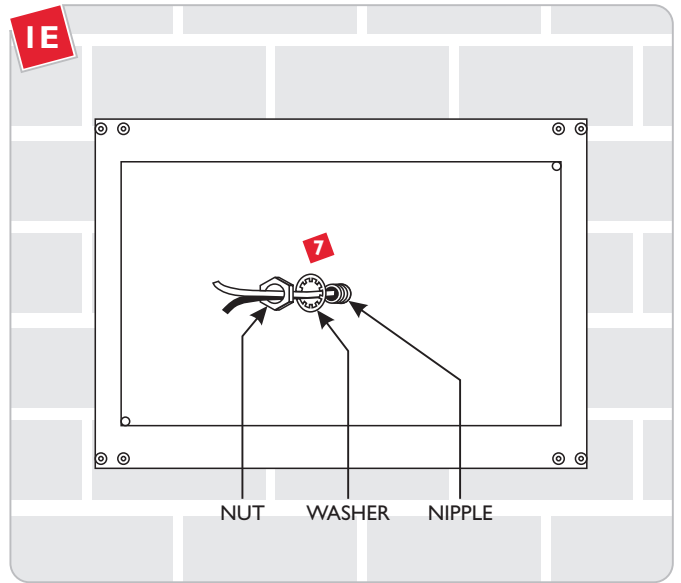

- 7** Make sure the fixture base is level, and secure it to the nipple with a lock washer and nut.

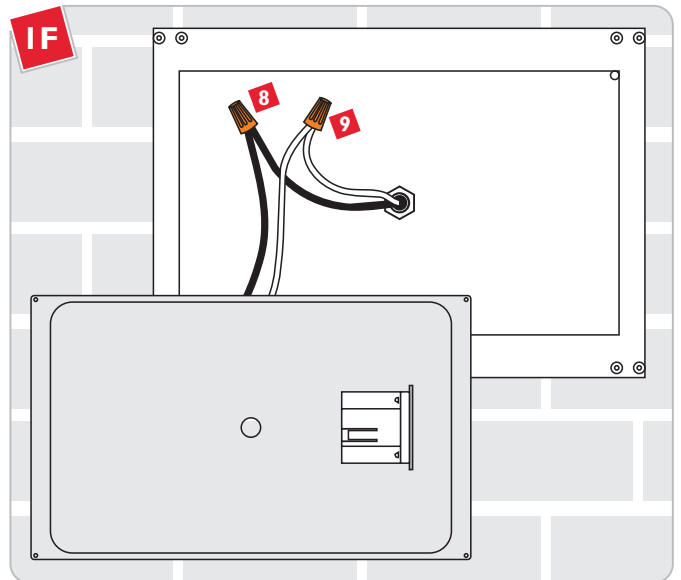

- 8** Connect the hot power line wire to the black ballast wire with a wire nut.
- 9** Connect the neutral power line wire to the white ballast wire with a wire nut.
- 10** Connect the fixture to a suitable ground according to local electrical codes.
- 11** Reattach the reflector to the fixture base.

Install the Lamp and Cover

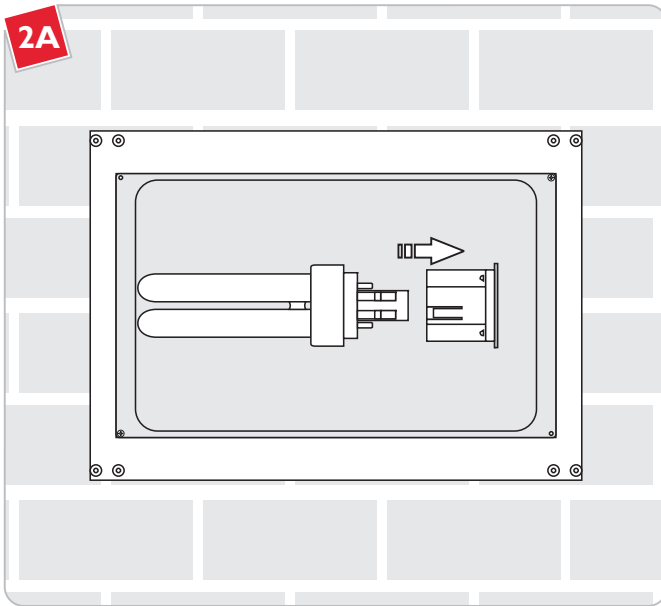

CAUTION: To reduce the risk of a burn or electric shock during relamping, disconnect the power to the fixture.

Use **MAX 18** Watt type quad tube G24Q-1 base compact fluorescent lamp.

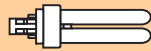

- 1 Push the lamp base into the socket.
- 2 Before continuing, turn on power to the fixture to verify all connections are good.

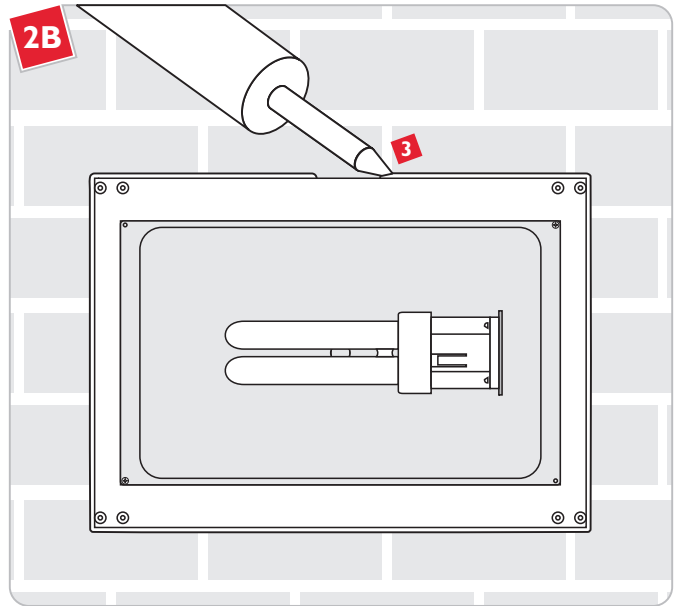

- 3 If installing in a wet location, caulk around the base with waterproof construction sealant.

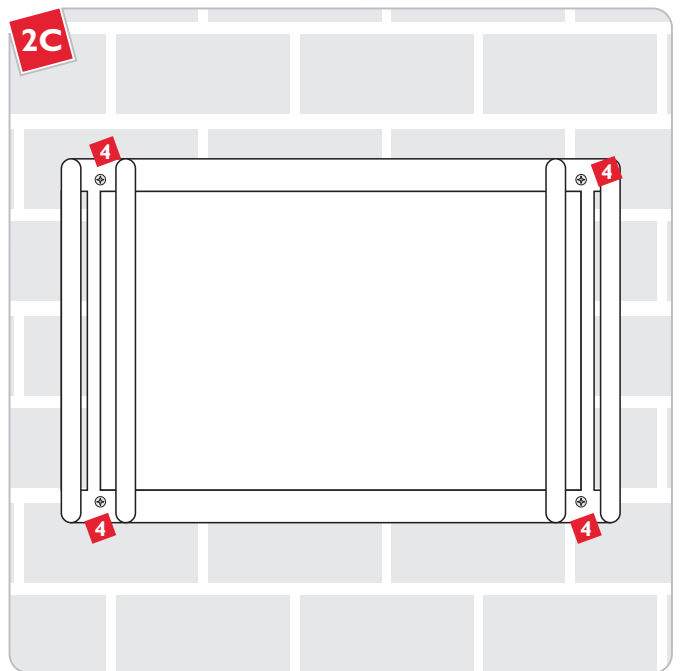

- 4 Replace the cover and reattach the screws to secure the cover to the fixture.

SAVE THESE INSTRUCTIONS!



7400 Linder Ave, Skokie, IL 60077

800.323.3226 - 847.626.6300

www.lblighting.com

© 2008 LBL Lighting. All rights reserved. The "LBL Lighting" graphic is a registered trademark of LBL Lighting. LBL Lighting reserves the right to change specifications for product improvements without notification.

A Generation Brands Company