

MODEL:DEC1101

NO.	ASSEMBLY NAME	QUANTITY	NO.	ASSEMBLY NAME	QUANTITY
(1)	CABINET	1	(7)	POP-UP WASTE	1
(2)	HANDLE	9	(8)	FAUCET	1
(3)	SCREW	9	(9)	MIRROR	1
(4)	SELF-TAPPING SCREW	9	(10)	SIDE CABINET	1
(5)	COUNTERTOP	1	(11)	DECORATIVE COVERS	2
(6)	BASIN	1			

1



2

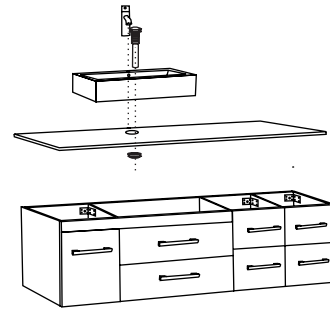

3

BACK

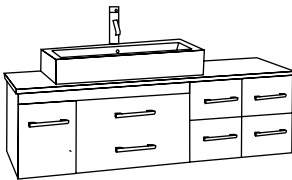
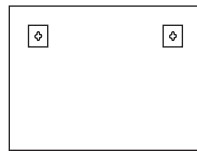
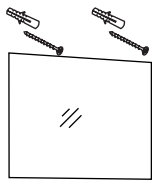

4

BACK

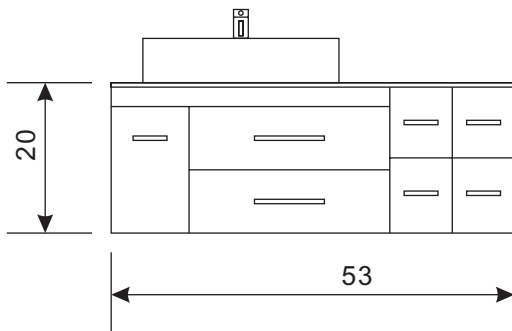
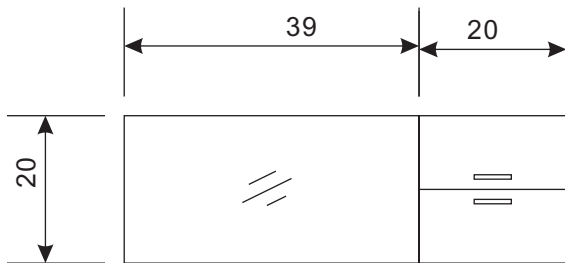
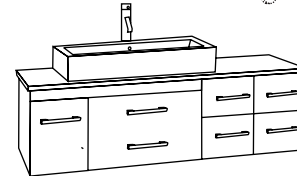
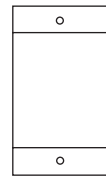
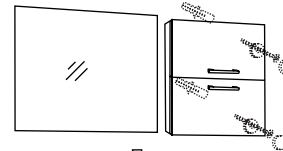

FRONT VIEW

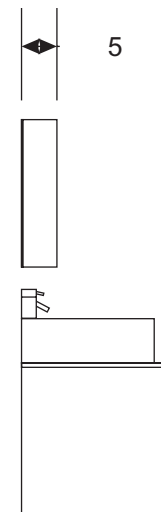

SIDE VIEW

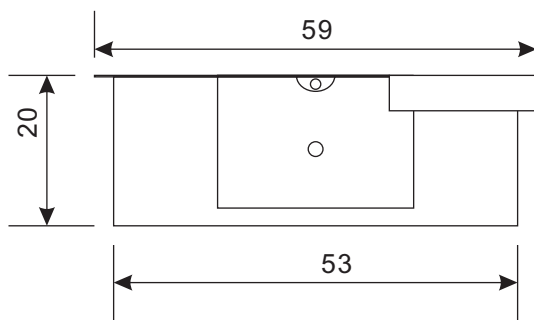

TOP VIEW

