

MODEL R5VI

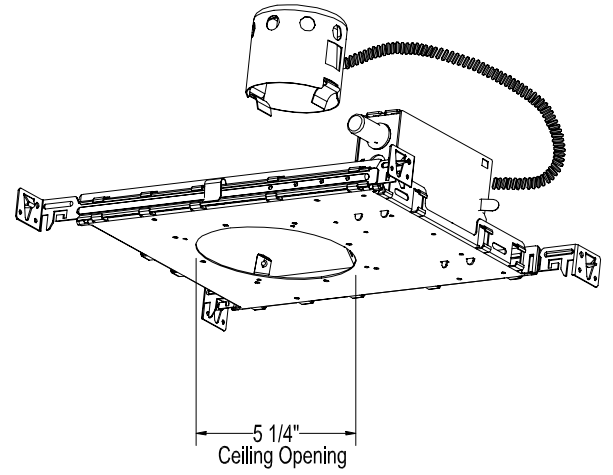

Ordering information

R5VI	-	-	-
Series	Housing Type	Options	Options
R5VI Recessed 5" Vertical Incandescent	R - Remodel Housing Blank - New Construction	ICA - Insulation Contact & Air Tight	

Product Features

Application: New construction housing frame-in kit. Requires 3" minimum clearance from insulation. Maximum 1-inch ceiling thickness.

J Box: Junction box is accessible from above or below the ceiling. Supplied with eight standard knockouts and four Integral Romex® clamps. Spring loaded door, for easy access to wiring. Approved for through branch wiring.

Mounting: Supplied with hanger bars adjustable to 25" Bars have score lines and can be cut to accommodate 12" joist spans. Bars have notches for easy installation on T-bars. Hanger bars mount on all four sides.

Material: Galvanized steel. Ceramic/nickel plated socket

Listing





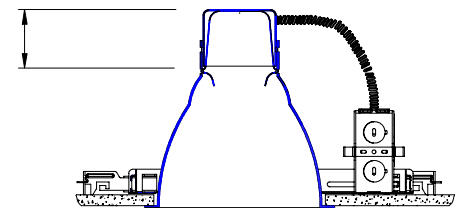







UL & CUL listed. Suitable for damp locations.

W.A.C. reserves the right to change details that do not affect overall function and performance.

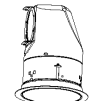

Socket cup adds a maximum of 2 1/8" to the height of the trim when used with frame in kits.



<p>R5VT-21-□□ Finishes: SC, SG Lamp: A19 100W, PAR30 75W</p>		<p>R5VT-22-□□ Finishes: WT Lamp: A19 75W PAR30 75W</p>		<p>R5VT-23-□□ Finishes: SBK, SC, SG, WT Lamp: A19 75W PAR30 50W</p>	
<p>R5VT-24-□□ Finishes: BK, WT Lamp: A19 75W PAR30 50W</p>		<p>R5VT-25-□□ Finishes: BK, WT Lamp: A19 75W PAR30 50W</p>		<p>R5VT-28-□□ Finishes: WT Lamp: A19 60W</p>	
<p>R5VT-29-□□ Finishes: SBK, SC, SG Lamp: PAR16 75W PAR20 50W PAR30 75W</p>		<p>R5VT-31-□□ Finishes: BK, WT Lamp: PAR16 75W PAR20 50W PAR30 75W</p>		<p>R5VT-32-□□ Finishes: WT Lamp: PAR16 75W PAR20 50W PAR30 75W</p>	
<p>R5VT-37-□□ Finishes: BK, WT Lamp: PAR20 50W</p>		<p>R5VT-39-□□ Finishes: WT Lamp: A19 60W PAR30 50W</p>		<p>R5VT-41-□□ Finishes: WT Lamp: A19 60W PAR30 50W</p>	
<p>R5VT-42-□□* Finishes: SC, SG Lamp: A19 60W PAR30 50W</p>					

Finish Key: BK-Black, SBK-Specular Black, SC-Specular Clear, SG-Specular Gold, WT-White
 All trims are white, finish choices refer to baffle or reflector color.
 *Trim finish is the same as the reflector.

