

<b>CATALOG NUMBER</b>	<b>TYPE</b>
<b>PROJECT</b>	

**LOW VOLTAGE 4" DOWNLIGHT**

**HR-8401H & HR-8401HF**

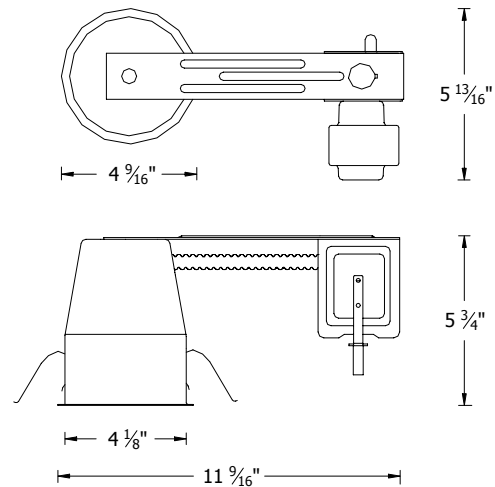

Ordering Matrix				
Series	Model Number	Transformer Type		Trim
<input type="text"/>	<input type="text"/>	<input type="text"/>		
<b>HR</b>	<b>8401</b>	<b>H</b>	<b>HF</b>	See page two

















Ordering Example (*series - model number - transformer type + trim*): HR-8401HF + HR-D419-BK/WT

Product Details	
<b>Description:</b>	Low voltage remodeling downlight with integral magnetic transformer.
<b>Materials:</b>	Housing and transformer arm are 20 gauge steel, housing is painted black. Electrical component within can is a bi-pin ceramic socket with 18 gauge teflon insulated wires with fiberglass sleeves.
<b>J-Box:</b>	Three 1/2" knockouts provided for wire entry and exit. Suitable for chain wiring.
<b>Lamp &amp; Transformer:</b>	Magnetic transformer for 12 volt MR16 lamps, 50w maximum. The 8401H model features a 120 volt input transformer. The 8401HF model features a 277 volt input transformer. MR16 lamps are sold separately.
<b>Ratings:</b>	Non-IC rated. Insulation must be kept at least 3" away from the housing. U.L. and C.U.L. listed. Suitable for damp locations
<b>Mounting:</b>	Snap-out style heavy gauge retention clips firmly hold housing to ceiling. Accommodates surface thickness of up to 3/4". 4 3/8" cutout hole.
<b>Thermal Protection:</b>	Thermal protector supplied with HR-8401H & 8401HF units protects against over-lamping.

Specification Features
<ul style="list-style-type: none"> <li>Small sized housing is compact enough to fit in 2x6 joist installations, allowing these to be used in "shallow" applications such as 2-story houses or where attic space is used for storage.</li> <li>Downlights feature long-life magnetic transformers with proven core and coil technology.</li> <li>Dimmable with magnetic low voltage dimmers.</li> <li>Both the transformer and junction box are accessible from below the ceiling.</li> <li>2 year W.A.C. Lighting product warranty.</li> </ul>

<b>CATALOG NUMBER</b>	<b>TYPE</b>
<b>PROJECT</b>	

**LOW VOLTAGE 4" DOWNLIGHT** **HR-8401H & HR-8401HF**

<b>Compatible Trims (max wattage for 8401 series is 50w):</b>					
<b>HR-8411-□□□□</b> Finishes: BK/BN, BK/PB, BK/WT, WT/WT Lamp: MR16, 75W max.		<b>HR-8412-□□□□</b> Finishes: BK/WT, WT/WT Lamp: MR16, 75W max.		<b>HR-8417-□□□□</b> Finishes: BK/WT, WT/WT Lamp: MR16, 75W max.	
<b>HR-8414-□□□□</b> Finishes: BK/BN, SC/BN, SC/WT, SG/WT Lamp: MR16, 75W max.					
<b>HR-D411-□□□□</b> Finishes: BK/BN, BK/PB, BK/WT, WT/WT Lamp: MR16, 75W max.		<b>HR-D415-□□□□</b> Finishes: BK/WT, WT/WT Lamp: MR16, 75W max.		<b>HR-D419-□□□□</b> Finishes: BK/WT, WT/WT Lamp: MR16, 50W max.	
<b>HR-D412-□□□□</b> Finishes: BK/BN, SC/BN, SC/WT, SG/WT Lamp: MR16, 75W max.		<b>HR-D416-□□</b> Finishes: BK, BN, WT Lamp: MR16, 75W max.		<b>HR-D420-□□</b> Finishes: CH, PB (inner ring) Lamp: MR16, 50W max.	
<b>HR-D413-□□</b> Finishes: BK, WT Lamp: MR16, 75W max.		<b>HR-D417-□□</b> Finishes: BK, BN, PB, WT Lamp: MR16, 75W max.		<b>HR-D423-□□</b> Finishes: AM, BL, WT Lamp: MR16, 75W max.	
<b>HR-D414-□□□□</b> Finishes: BK/PB, BK/WT, WT/WT Lamp: MR16, 75W max.		<b>HR-D418-□□</b> Finishes: WT Lamp: MR16, 50W max.		<b>HR-D425-□□</b> Finishes: BK, BN, WT Lamp: MR16, 75W max.	

Finish Key:

AM Amber, BL-Blue, BK-Black, BN-Brushed Nickel, CH-Chrome, PB-Polished Brass, SC-Specular Clear, SG-Specular Gold, WT-White

Notes: **The full catalog number for a complete downlight includes the model numbers for both the trim and the housing.**

**More information regarding each individual trim can be viewed on the individual trim spec sheets.**