

CATALOG NUMBER	TYPE
PROJECT	

6" LINE VOLTAGE DOWNLIGHTS

R-660S-N-A

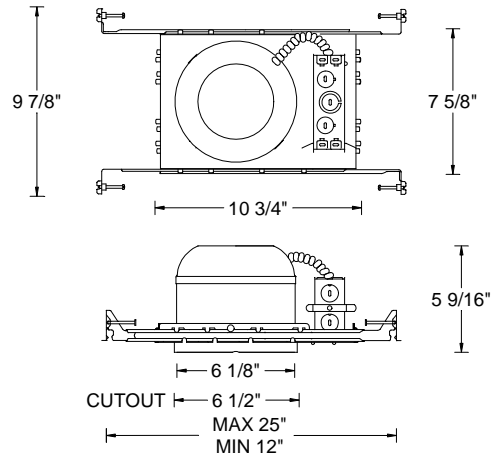











Ordering Matrix		
Model	Installation Type	Options
[]	[]	[]
R-660S: Recessed 6 inch series Shallow housing	R-Remodel Housing N-New construction	A : Air Tight

Product Details	
Description:	Line voltage new construction shallow housing.
Materials:	Housing is 20 gauge steel, painted white. Frame, junction box and hanger bars are heavy gauge galvanized steel.
Mounting:	Supplied with hanger bars, adjustable from 12"-24" to accommodate various joist construction and grid sizes. Hanger bars include a captive mounting "screw-nail" for ease of installation. Accommodates surface thickness of up to 1". 6 1/2" cutout hole.
Ratings:	Non-IC rated. Insulation must be kept at least 3" away from the housing.
J-Box:	Seven knockouts and four Romex® style wiring connectors provided for ease of installation. Rated for branch and chain wiring.
Thermal Protection:	Thermal protector supplied with R-660S-N-A protects against over-lamping.
Listing:	UL & CUL Listed. Suitable for damp locations.

Specification Features
<ul style="list-style-type: none"> • Small sized downlight is compact enough to fit in 2x6 joist installations, allowing these to be used in "shallow" such as multi-story dwellings or where attic space is used for storage. • Hanger bars slots are located on all four sides of the frame. • Certified Air Tight per ASTM E283. • 5 year W.A.C. Lighting product warranty.

Compatible Trims (Sold separately)

<p>R-620 Step baffle</p> <table border="1"> <thead> <tr> <th>Finish</th> <th>Baffle</th> <th>Trim</th> </tr> </thead> <tbody> <tr> <td>BK/WT</td> <td>Black</td> <td>White</td> </tr> <tr> <td>BN</td> <td>Brushed Nickel</td> <td>Brushed Nickel</td> </tr> <tr> <td>BZ</td> <td>Bronze</td> <td>Bronze</td> </tr> <tr> <td>WT/WT</td> <td>White</td> <td>White</td> </tr> </tbody> </table> <p>Lamp:75W PAR30, 75W R30</p>	Finish	Baffle	Trim	BK/WT	Black	White	BN	Brushed Nickel	Brushed Nickel	BZ	Bronze	Bronze	WT/WT	White	White		<p>R-621 Step baffle</p> <table border="1"> <thead> <tr> <th>Finish</th> <th>Baffle</th> <th>Trim</th> </tr> </thead> <tbody> <tr> <td>BK/WT</td> <td>Black</td> <td>White</td> </tr> <tr> <td>BN</td> <td>Brushed Nickel</td> <td>Brushed Nickel</td> </tr> <tr> <td>BZ</td> <td>Bronze</td> <td>Bronze</td> </tr> <tr> <td>WT/WT</td> <td>White</td> <td>White</td> </tr> </tbody> </table> <p>Lamp:75W PAR38, 75W R40</p>	Finish	Baffle	Trim	BK/WT	Black	White	BN	Brushed Nickel	Brushed Nickel	BZ	Bronze	Bronze	WT/WT	White	White	
Finish	Baffle	Trim																															
BK/WT	Black	White																															
BN	Brushed Nickel	Brushed Nickel																															
BZ	Bronze	Bronze																															
WT/WT	White	White																															
Finish	Baffle	Trim																															
BK/WT	Black	White																															
BN	Brushed Nickel	Brushed Nickel																															
BZ	Bronze	Bronze																															
WT/WT	White	White																															
<p>R-656 Open reflector</p> <table border="1"> <thead> <tr> <th>Finish</th> <th>Reflector</th> <th>Trim</th> </tr> </thead> <tbody> <tr> <td>CL/WT</td> <td>Specular Clear</td> <td>White</td> </tr> <tr> <td>BN</td> <td>Specular Clear</td> <td>Brushed Nickel</td> </tr> <tr> <td>BZ</td> <td>Specular Clear</td> <td>Bronze</td> </tr> </tbody> </table> <p>Lamp:75W PAR30, 75W R30</p>	Finish	Reflector	Trim	CL/WT	Specular Clear	White	BN	Specular Clear	Brushed Nickel	BZ	Specular Clear	Bronze		<p>R-657 Open reflector</p> <table border="1"> <thead> <tr> <th>Finish</th> <th>Reflector</th> <th>Trim</th> </tr> </thead> <tbody> <tr> <td>CL/WT</td> <td>Specular Clear</td> <td>White</td> </tr> <tr> <td>BN</td> <td>Specular Clear</td> <td>Brushed Nickel</td> </tr> <tr> <td>BZ</td> <td>Specular Clear</td> <td>Bronze</td> </tr> </tbody> </table> <p>Lamp:75W PAR38, 75W R40</p>	Finish	Reflector	Trim	CL/WT	Specular Clear	White	BN	Specular Clear	Brushed Nickel	BZ	Specular Clear	Bronze							
Finish	Reflector	Trim																															
CL/WT	Specular Clear	White																															
BN	Specular Clear	Brushed Nickel																															
BZ	Specular Clear	Bronze																															
Finish	Reflector	Trim																															
CL/WT	Specular Clear	White																															
BN	Specular Clear	Brushed Nickel																															
BZ	Specular Clear	Bronze																															
<p>R-622 Step baffle</p> <table border="1"> <thead> <tr> <th>Finish</th> <th>Baffle</th> <th>Trim</th> </tr> </thead> <tbody> <tr> <td>BK/WT</td> <td>Black</td> <td>White</td> </tr> <tr> <td>BN</td> <td>Brushed Nickel</td> <td>Brushed Nickel</td> </tr> <tr> <td>BZ</td> <td>Bronze</td> <td>Bronze</td> </tr> <tr> <td>WT/WT</td> <td>White</td> <td>White</td> </tr> </tbody> </table> <p>Lamp: 60W A19</p>	Finish	Baffle	Trim	BK/WT	Black	White	BN	Brushed Nickel	Brushed Nickel	BZ	Bronze	Bronze	WT/WT	White	White		<p>R-658 Open reflector</p> <table border="1"> <thead> <tr> <th>Finish</th> <th>Reflector</th> <th>Trim</th> </tr> </thead> <tbody> <tr> <td>CL/WT</td> <td>Specular Clear</td> <td>White</td> </tr> <tr> <td>BN</td> <td>Specular Clear</td> <td>Brushed Nickel</td> </tr> <tr> <td>BZ</td> <td>Specular Clear</td> <td>Bronze</td> </tr> </tbody> </table> <p>Lamp:75W A19</p>	Finish	Reflector	Trim	CL/WT	Specular Clear	White	BN	Specular Clear	Brushed Nickel	BZ	Specular Clear	Bronze				
Finish	Baffle	Trim																															
BK/WT	Black	White																															
BN	Brushed Nickel	Brushed Nickel																															
BZ	Bronze	Bronze																															
WT/WT	White	White																															
Finish	Reflector	Trim																															
CL/WT	Specular Clear	White																															
BN	Specular Clear	Brushed Nickel																															
BZ	Specular Clear	Bronze																															
<p>R-633 Gimbal ring</p> <table border="1"> <thead> <tr> <th>Finish</th> <th>Trim</th> </tr> </thead> <tbody> <tr> <td>BN</td> <td>Brushed Nickel</td> </tr> <tr> <td>BZ</td> <td>Bronze</td> </tr> <tr> <td>WT</td> <td>White</td> </tr> </tbody> </table> <p>Lamp: 75W PAR30</p>	Finish	Trim	BN	Brushed Nickel	BZ	Bronze	WT	White		<p>R-636 Gimbal ring</p> <table border="1"> <thead> <tr> <th>Finish</th> <th>Trim</th> </tr> </thead> <tbody> <tr> <td>BN</td> <td>Brushed Nickel</td> </tr> <tr> <td>BZ</td> <td>Bronze</td> </tr> <tr> <td>WT</td> <td>White</td> </tr> </tbody> </table> <p>Lamp: 75W PAR38</p>	Finish	Trim	BN	Brushed Nickel	BZ	Bronze	WT	White															
Finish	Trim																																
BN	Brushed Nickel																																
BZ	Bronze																																
WT	White																																
Finish	Trim																																
BN	Brushed Nickel																																
BZ	Bronze																																
WT	White																																
<p>R-635 Eyeball</p> <table border="1"> <thead> <tr> <th>Finish</th> <th>Trim</th> </tr> </thead> <tbody> <tr> <td>BN</td> <td>Brushed Nickel</td> </tr> <tr> <td>BZ</td> <td>Bronze</td> </tr> <tr> <td>WT</td> <td>White</td> </tr> </tbody> </table> <p>Lamp: 75W PAR30L, 75W R30</p>	Finish	Trim	BN	Brushed Nickel	BZ	Bronze	WT	White		<p>R-640 Scoop wall wash with step baffle</p> <table border="1"> <thead> <tr> <th>Finish</th> <th>Baffle</th> <th>Trim</th> </tr> </thead> <tbody> <tr> <td>WT/WT</td> <td>White</td> <td>White</td> </tr> </tbody> </table> <p>Lamp: 60W A19</p>	Finish	Baffle	Trim	WT/WT	White	White																	
Finish	Trim																																
BN	Brushed Nickel																																
BZ	Bronze																																
WT	White																																
Finish	Baffle	Trim																															
WT/WT	White	White																															
<p>R-651 Shower Light</p> <table border="1"> <thead> <tr> <th>Finish</th> <th>Trim</th> </tr> </thead> <tbody> <tr> <td>WT</td> <td>White</td> </tr> </tbody> </table> <p>Lamp: 60W A19</p>	Finish	Trim	WT	White																													
Finish	Trim																																
WT	White																																

Finish Key:

BK-Black, BN-Brushed Nickel, CL-Specular Clear, WT-White, BZ- Bronze

Notes:

The full catalog number for a complete downlight includes the model numbers for both the trim and the housing. More information regarding each individual trim can be viewed on the individual trim spec sheets.

W.A.C. reserves the right to change details that do not affect overall function and performance.