

CONTENTS

INTRODUCTION.....	1
MOUNTING RECOMMENDATIONS	2
PREPARATION INSTRUCTIONS	3
FAN INSTALLATION	4
CONTROL FEATURES:	
INTELI•TOUCH OPERATION	8
INTELI•TOUCH TROUBLESHOOTING	11
ADVAN•TOUCH OPERATION	12
ADVAN•TOUCH TROUBLESHOOTING	15

READ AND SAVE THESE INSTRUCTIONS

SAFETY FIRST

Safety and the proper operation of your Casablanca fan both require a thorough knowledge of the product and proper installation; therefore, before attempting to install and operate your Casablanca fan, read this owner's manual completely and carefully. Retain this manual for future reference.

CAUTION: To avoid possible electrical shock, make certain that electricity is turned off at the circuit breaker or fuse box before attempting any installation procedure.

BEFORE YOU START

- **CAUTION: RISK OF ELECTRICAL SHOCK!** All wiring must be performed in accordance with national and local electrical codes. If you are unfamiliar with the wiring codes, you should use a qualified electrician. To avoid overheating and possible damage to other equipment, do not install control to a receptacle, fluorescent light fixture, motor operated appliance, or transformer-supplied appliance..
- This fan is designed to be installed on an existing electrical outlet box. The outlet box must be UL Listed for ceiling fan installations, if it is not, a new box must be installed. Casablanca extension poles are available for sloped or high ceiling installations.
- This ceiling fan requires a grounded electrical supply of 120 VAC, 60 Hz and a minimum 15 amp circuit. The maximum current requirement for the fan with light fixture is 3.8 amps. The fan uses about 1 amp or 100 watts. Maximum light current is 2.8 amps or 340 watts of lighting.
- Where wire nuts are employed, be sure all bare wires are within the connectors. When installing the canopy hatch, make sure all wires are within the canopy and that no wires are being pinched.

**For best performance and for your warranty to be valid,
use only genuine Casablanca blades, light fixtures, and accessories.**

SAFE USE

- The blades in each pack are matched for equal weight to assure smooth fan operation. If more than one fan is being installed, be careful not to mix blades from different cartons.
- Inspect the contents of your carton for possible shipping or handling damage and report any such damage directly to your authorized Casablanca dealer.
- It is always a good idea to have an assistant to help with the installation.
- When cleaning, painting, or working near your fan, be very careful of the fan and blades. Always turn the power OFF to the ceiling fan before servicing it, working on it, or replacing light bulbs.
- Never insert anything into the path of the fan blades while the fan is in operation.
- Never install a fan over a pool or spa.
- Never operate a fan that has been damaged in any way. Contact Casablanca Fan Company by calling toll free 1-888-227-2178, or contact your local authorized Casablanca dealer for assistance in obtaining service.

**FUSE BOX
(REMOVE FUSE FOR THE
CIRCUIT YOU WILL BE
WORKING ON)**

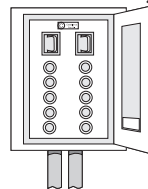

**CIRCUIT BREAKER
(TRIP BREAKER FOR THE
CIRCUIT YOU WILL BE
WORKING ON)**

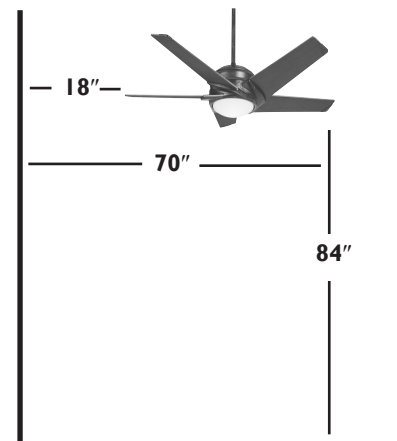
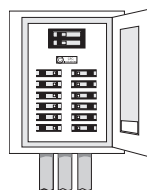

MOUNTING RECOMMENDATIONS

Before mounting your Casablanca fan, read the following helpful recommendations. The location of the fan, air circulation, and fan size are all important factors to consider before installation.

Location

Ceiling fans have practical uses in almost every room in your home. We suggest you follow these mounting recommendations as you decide where to install your Casablanca fan.

- For safety reasons, the fan blades must be a minimum of 7' above the floor.
- Do not locate the fan in a doorway or above a swinging door.
- In any installation, the tips of the blades must be at least 18" from the wall in order to provide sufficient clearance for the blades.
- In bedrooms, fans work best when mounted above the foot of the bed.
- Over pool tables, be sure to provide plenty of clearance to avoid damage from pool cues.
- In kitchens be sure to allow for open cupboard doors to clear the fan blades.
- Do not install a fan close to, or over, a pool or spa. High humidity combined with corrosive gases will destroy the finish and warp the blades.

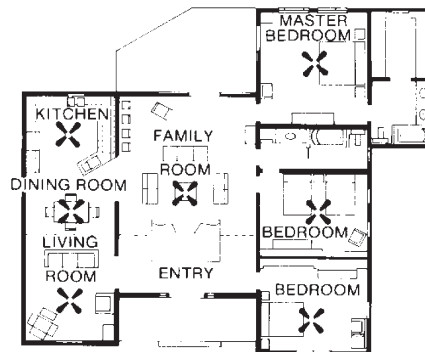

Fan Size

Variable fan speed capability permits the use of a full-size 52" fan even in smaller rooms. For very large rooms, two fans may be needed.

SLOPED CEILING INSTALLATIONS

<i>Suggested Extension Pole Lengths</i>	
Ceiling Height	Pole Length
8'	Standard
8' 6"	Standard
9'	6"
9' 6"	12"
10'	12"
11'	18"
12'	24"
13'	36"
14'	48"

When to Use Extension Poles

For best performance and best appearance, an extension pole should be used with your Casablanca fan when installing on high (cathedral) ceilings or sloped ceilings. Casablanca offers standard poles in increments of 6" up to 5'. Custom poles are available in lengths up to 9'.9" See your Authorized Casablanca Dealer for details.

Note: Fan may wobble or vibrate if pole length is not long enough and inside blade is too close to downslope or side wall. Extending pole length will usually solve problem.

Calculation of 32°

Use the tear-off *Ceiling Angle Template* card inserted in the back of this manual, it provides you with a simple 'go' or 'no-go' for installing your fan on a sloped ceiling.

EXAMPLE 1

This slope is less than 32°. It is OK to install your fan.

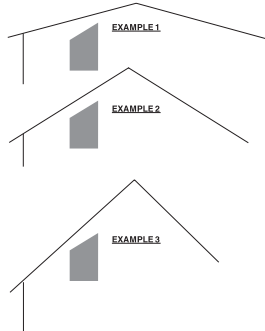
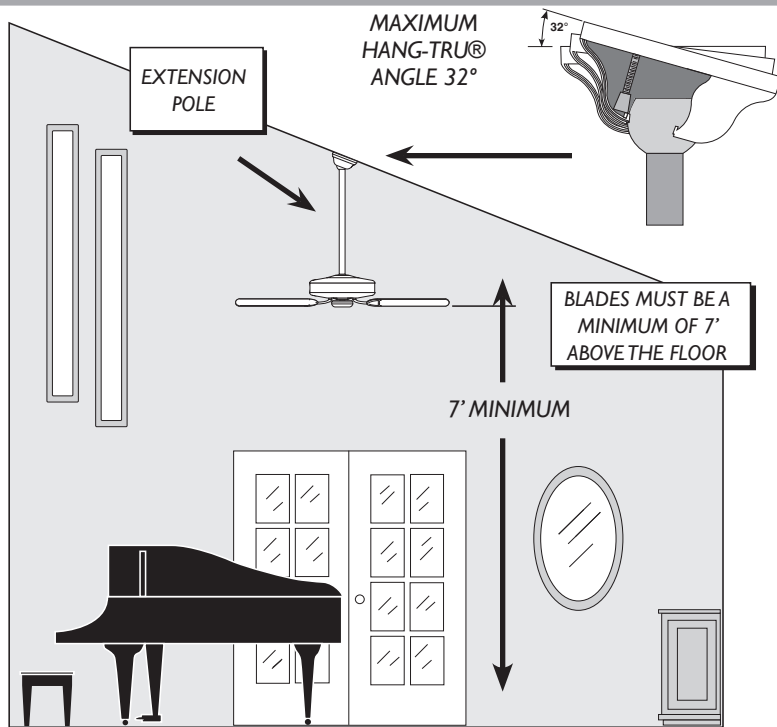

EXAMPLE 2

This slope is 32°. This is the maximum slope that will allow the fan to hang straight down. It is OK to install your fan.

EXAMPLE 3

This slope is more than 32°. Your fan will not hang straight down, an adaptor is necessary. Contact your local Authorized Casablanca Dealer in regards to purchasing a "Slope Ceiling Adaptor."



STEALTH INSTALLATION INSTRUCTIONS

Unpacking: Before assembling and installing your ceiling fan, remove all parts from the shipping cartons and check them against the parts listed here. Before discarding packaging material, be certain that all parts have been removed.

PERMA•LOCK™ HARDWARE



ALLEN SET SCREW
1/4-20 x 1/4"
(PRE-INSTALLED)



3mm
ALLEN WRENCH

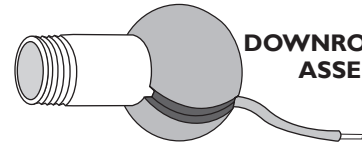

DOWNROD & BALL ASSEMBLY

FAN PREPARATION

IMPORTANT SAFETY INFORMATION!

BEFORE STARTING THE INSTALLATION OF YOUR CEILING FAN, INSTALL THE THREADED DOWNROD INTO THE MOTOR COUPLING AND LOCK THE ASSEMBLY

Prepare for fan installation as follows:

Step A. Route the wires from the motor through the Perma•Lock™ downrod and ball assembly.

Tip: The downrod has a tapered thread that is designed to lock completely when correctly installed.

Step B. Using the provided allen wrench, loosen the set screw several turns to allow installation of the downrod. Thread the downrod into the motor coupling until it stops turning, this will take at least four and a half full turns.

Step C. Securely tighten the set screw with the provided allen wrench to ensure safe operation of your fan.

CAUTION: Failure to fully lock in the downrod before securely tightening the allen set screw may cause the fan to separate from the downrod during normal operation!

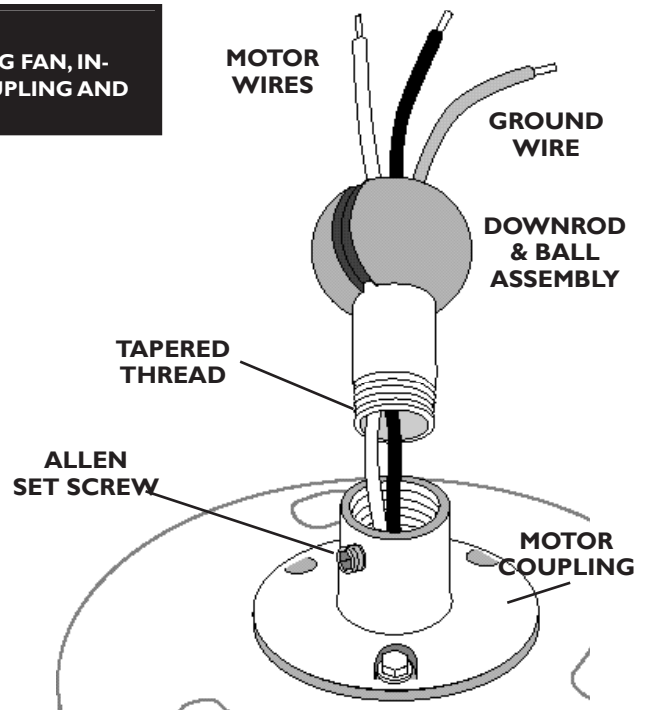

CEILING HARDWARE

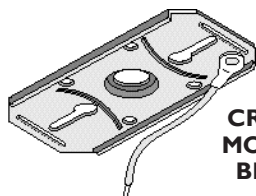

CROSSBAR MOUNTING BRACKET



WIRE NUT (4)

ADDITIONAL HARDWARE

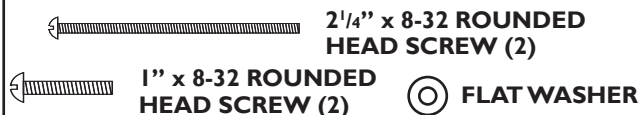

2 1/4" x 8-32 ROUNDED HEAD SCREW (2)

1" x 8-32 ROUNDED HEAD SCREW (2)

FLAT WASHER (2)

SUPPORT INSTALLATION PARTS



LAG SCREW
3/8" #7 X 5" (1)



LARGE FLAT WASHER
3/8" (1)

CROSSBAR MOUNTING BRACKET INSTALLATION

Note: After removing the old fixture, check the outlet box to insure that it is supported by a joist or beam across its upper surface. If not, a 2" x 4" stud must be installed.

Step 1. Remove the knockout plug in the center of the outlet box or drill a 1/2" hole for the lag screw to pass through. Then drill a 1/4" guide hole into the joist or beam to a depth of 3".

Step 2. Route the outlet box wires through the keyhole slot of the crossbar mounting bracket as shown. Attach the crossbar mounting bracket to outlet box with screws provided, assuring that the outlet box wires are not pinched by the washer.

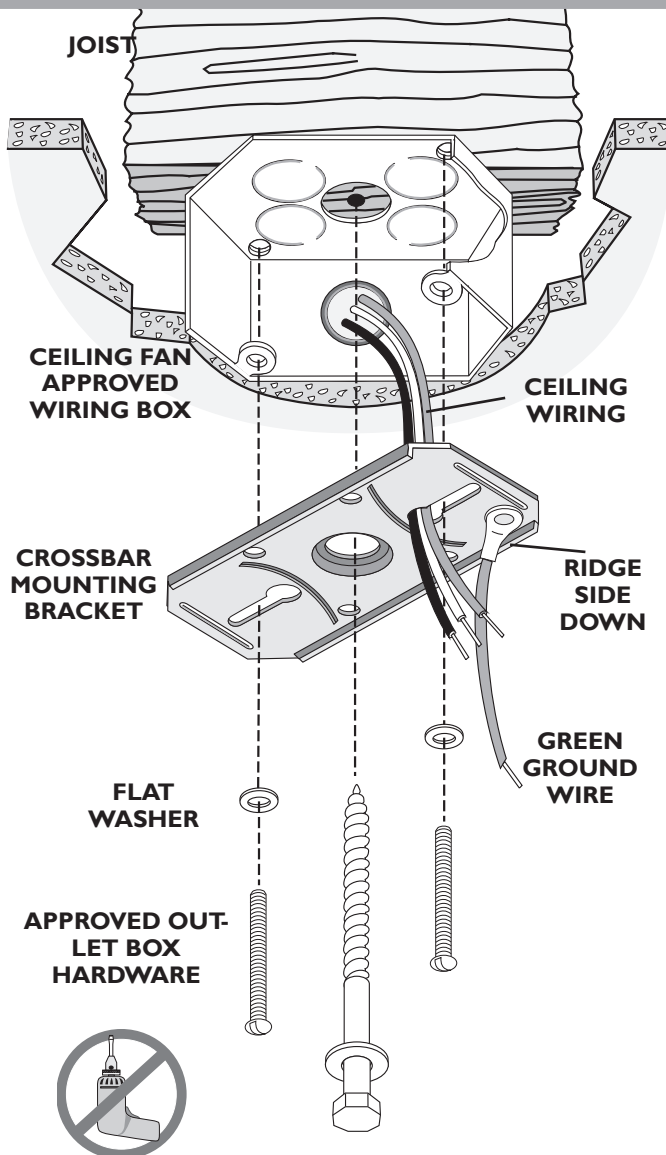

CAUTION: To reduce the risk of personal injury, use only the mounting hardware provided with the approved outlet box to install the crossbar mounting bracket.

WARNING!
SUPPORT DIRECTLY TO BUILDING STRUCTURE ONLY.



LAG SCREW INSTALLATION

Step 3. With the large washer attached, pass the lag screw through the center hole of the crossbar mounting bracket and screw into guide hole. Tighten until outlet box is firmly mounted to beam. This box must be firmly secured to the ceiling. We recommend that the ceiling fixture outlet box be of sufficient capacity enabling it to support the weight of fan and light fixture under any conditions.

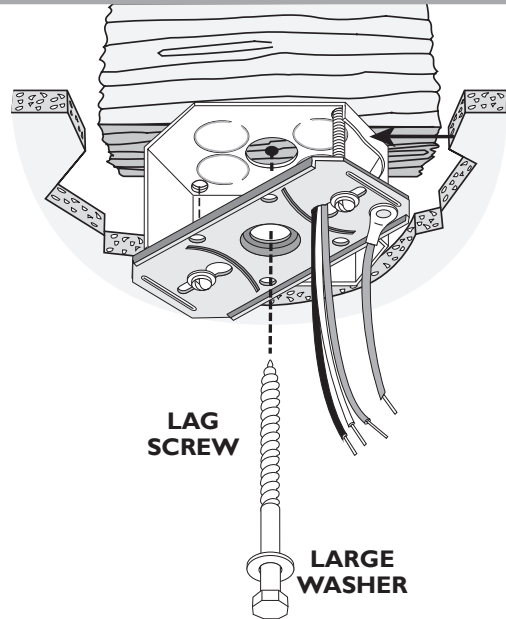

CANOPY HARDWARE

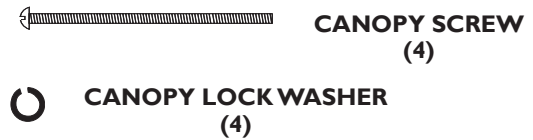
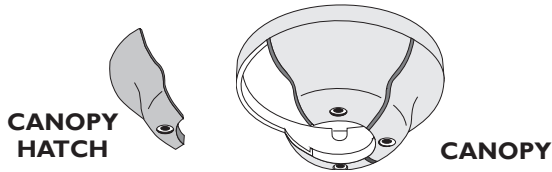

CANOPY INSTALLATION

Step 4. Attach the canopy to the crossbar mounting bracket with three of the 8-32 x 2 1/2" long canopy screws and lock washers provided with your Casablanca fan. Hand tighten until snug against the ceiling.

***Note:** On sloped ceilings, align the canopy opening toward the top or peak of the room.*

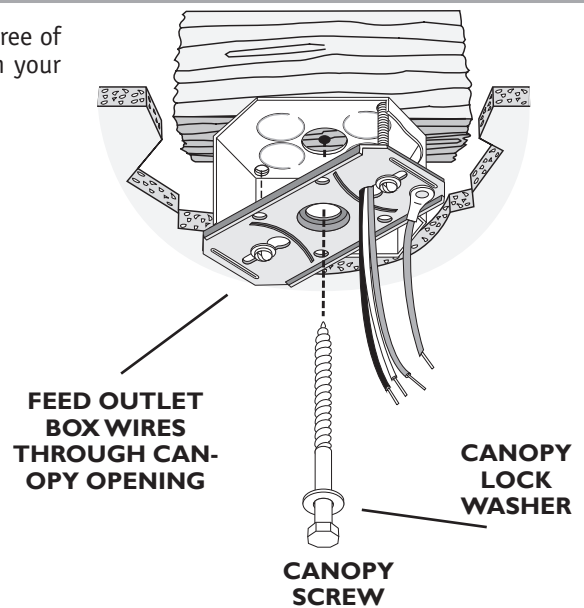

ATTACHING THE BLADES

Step 3a. Attach the 5 blade tips to the blades using two 6-32x $\frac{1}{8}$ " round head screws provided. *Note: the screws have locktite on them, so once they are installed it will be difficult to remove the screws.*

Step 3b. Attach each of the five blades to the blade holders using four of the truss head screws and fiber washers provided for each blade. The truss head screw is placed through the blade and then a fiber washer is pressed on so that it is between the blade and blade holder; see the detail drawing below. **Hand** tighten each truss head screw firmly.

3a - BLADE TIP INSTALLATION:

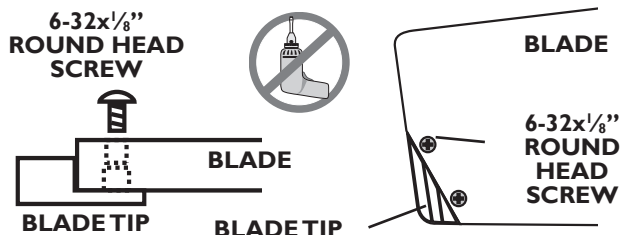

3b - BLADE INSTALLATION:

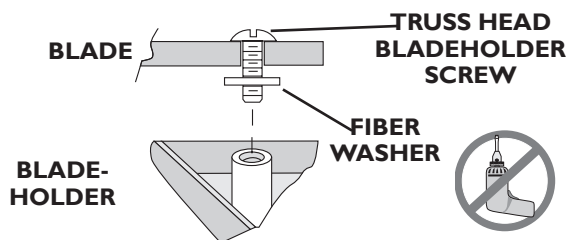
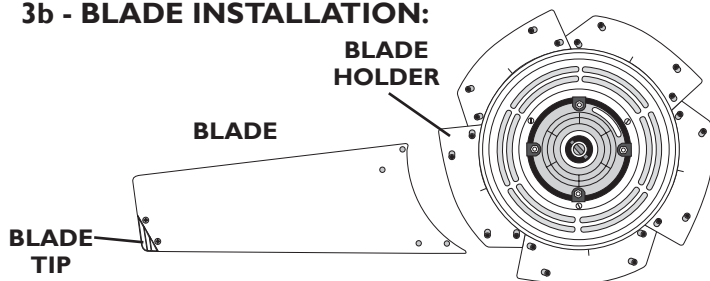

HANGING FAN BODY IN CANOPY

Step 4. To hang the fan body in the canopy, support the fan at the center of the glass holder and top support and insert the ball into the canopy opening. Rotate the fan body until the slot in the ball fits into the pin opposite the canopy opening.

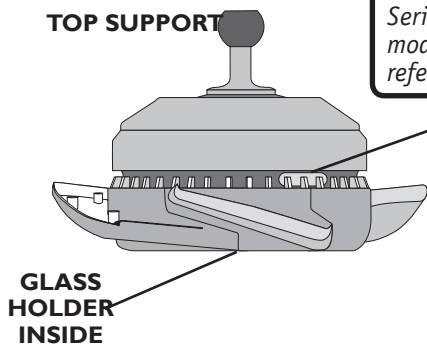

Note: Write down the Serial Number and the model number for future reference.

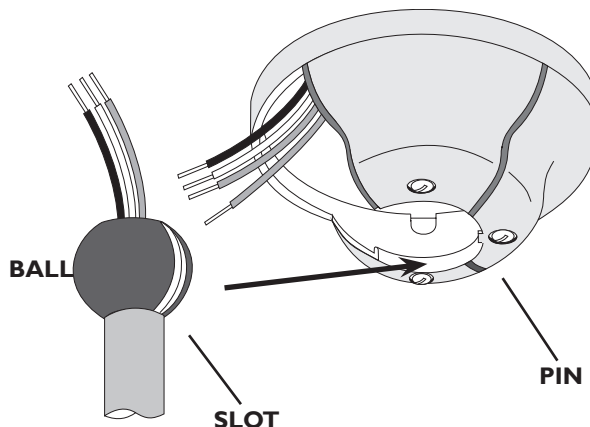

Note: Fan Weight is 33 lbs.

CANOPY ELECTRICAL CONNECTORS

Step 5. Attach the fan wires to the ceiling fixture outlet box wiring by twisting the bare ends of the wires together and securing with a wire nut. Connect in this order:

- GREEN leads from mounting plate and fan to GROUND conductor of power source. Secure with wire nut.
- WHITE wire from fan to white NEUTRAL wire in ceiling fixture outlet box. Secure with wire nut.
- BLACK wire from fan to black (or red) POWER wire in ceiling fixture outlet box. Secure with wire nut.

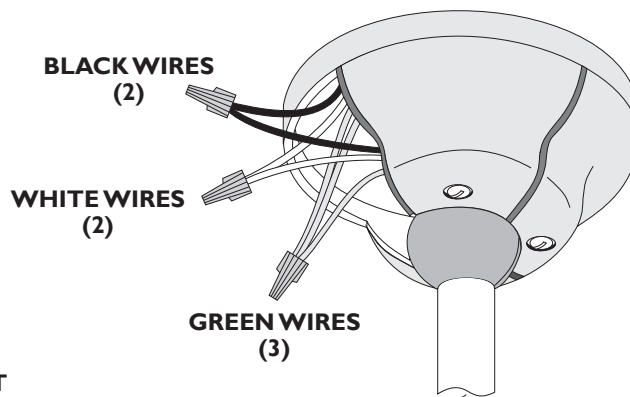



CANOPY HATCH INSTALLATION

Step 6. Tuck the wires into the canopy with the wire nuts pointed upwards, so that the white and black wires are on opposite sides of the canopy and all wires are clear of the canopy opening.

Step 7. Install canopy hatch with the last canopy screw and lock washer. To do this, tilt the fan body away from the hatch opening.

Tip: Place the lock washer on the canopy screw, and the screw through the hatch before tilting the fan to install the hatch onto the canopy.

Step 8. Straighten the fan, then check to ensure that there is no movement between the canopy and ceiling or Hang-Tru ball and downrod.

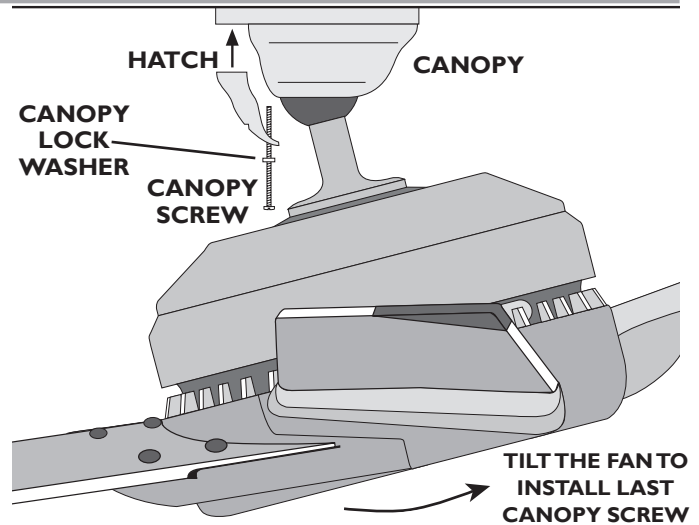

BULB INSTALLATION

Step 9. Screw the 100-watt Halogen bulb into the socket. Do not touch the glass bulb with your fingers—it is extremely important that the glass be clean. If it is touched, or dirty, clean carefully with a tissue. A dirty glass bulb will cause the bulb to fail almost immediately.

IMPORTANT! When installing the halogen bulb, carefully cut off the end of the plastic sleeve the bulb comes in and hold the bulb by the plastic sleeve to screw it into the socket.

NOTE: In compliance with US Federal Energy Regulations, this ceiling fan contains a device that restricts the light kit to a maximum of 190 watts. Exceeding that limit or the marked limit on this product may result in a fire hazard or improper operation.

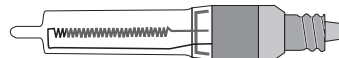
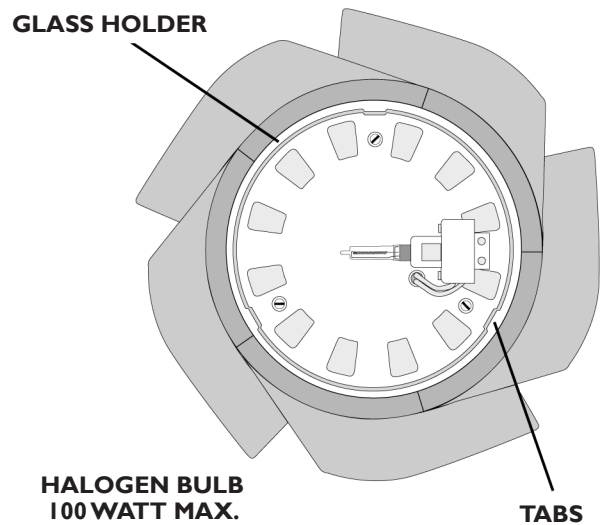

INSTALLING THE GLASS

Step 10. Position the indentations in the outer rim of the glass so that they line up with the tabs on the inside surface of the fan light fixture rim.

Step 11. Carefully lift the glass shade up inside the light fixture as far as it will go.

Step 12. Rotate the glass shade in a clockwise direction until it falls into the notch for each tab.

Step 13. Turn power back ON at the circuit breaker or fusebox. This completes the installation of the fan.

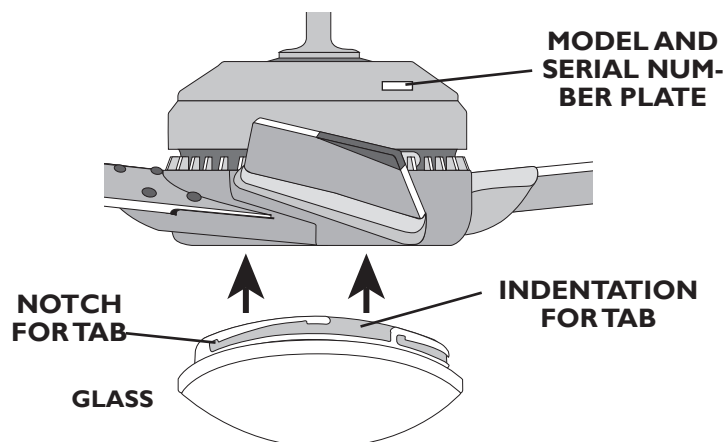

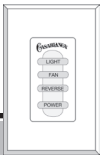

INTELI-TOUCH OPERATION POWER

The **POWER** button is normally left in the on position. Always turn the power off during cleaning or servicing the fan and during thunderstorms. It is also used to exit or enter additional programs.

POWER must be left on to retain a previously set fan speed or light level.

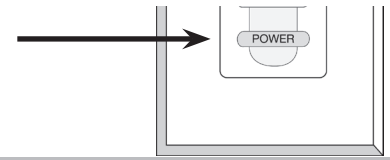

INTELI-TOUCH OPERATION SPEED CONTROL

There are six individual speed settings for the fan; each speed is indicated by an audible tone of increasing pitch.

To select the desired fan speed:

1. With fan off, press and hold the button labeled **FAN**. The fan blades will start rotating at the slowest speed, and will increase in steps.
2. Release the button when the desired speed is reached.

The fan speed is now in memory and will automatically come on at the same speed each time the **FAN** button is used. To maintain this level of speed, turn the fan on by pressing **FAN** less than one second. To lower speed, turn fan off, then on by pressing and holding the **FAN** button until the desired speed is reached. When the fan is on, you may increase the speed by pressing and holding the **FAN** button until the desired speed is reached, then release it.

FAN CONTROL

ON - OFF
A momentary press of the **FAN** button

TO CHANGE SPEED
Press and hold **FAN** button longer than one second

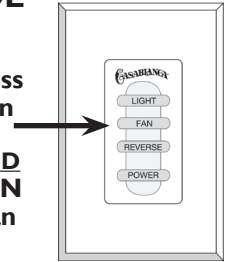

INTELI-TOUCH · REVERSING AIRFLOW

The direction of airflow can be changed from downward to upward or from upward to downward.

To reverse the airflow:

1. Make sure the **FAN** is on.
2. Press the **REVERSE** button.

Note: A four-toned signal indicates the command was accepted by the fan. A few seconds later the fan will slow to a stop and then reverse direction.

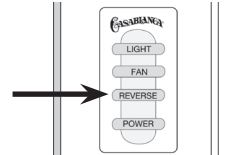

INTELI-TOUCH LIGHT

To turn the lights off and on, press and release the **LIGHT** button for less than one second.

To vary the light brightness:

1. With lights off, press and hold the **LIGHT** button. After one second the lights come on at their lowest level and gradually become brighter.
2. Release the button when the desired brightness level is reached.

The brightness level is now in the fan memory and will automatically come on at the same brightness the next time the **LIGHT** button is used. To maintain this level of brightness, press the **LIGHT** button for less than one second. To lower the brightness, turn the lights off, then press and hold the **LIGHT** button until the desired brightness level is reached. When the light is on, you may increase the brightness level by pressing and holding the **LIGHT** button until the desired level is reached, then release it.

LIGHT CONTROL

ON - OFF
A momentary press of the **LIGHT** button

TO CHANGE BRIGHTNESS
PRESS AND HOLD **LIGHT** BUTTON LONGER THAN ONE SECOND

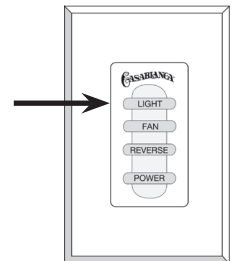

AUTOMATIC DEMONSTRATION PROGRAM

Programmed into every Intelli-Touch Series fan is an Automatic Demonstration Program. It can be used to fully demonstrate and test the operation of the fan.

To enter the demonstration program:

1. Turn **POWER** off for at least three seconds. This will clear the fan memory ready for programming.
2. Turn **POWER** on.
3. Immediately operate the buttons in the following sequence:



A multi-tone signal will verify the start of the test program which proceeds as follows:

- Lights slowly increase to full intensity.
- Fan accelerates to speed three with audio tones.
- Light dims to half intensity.
- Fan accelerates to full speed with audio tones.
- Fan reverses at full speed with audio tones.
- Fan operates at full speed.
- Fan power is reversed with audio tones.
- Fan turns off with audio tones (blades coast for a short time).
- Lights turn off.

The complete cycle lasts slightly over one minute. It will continue to repeat until the **POWER** is turned off for more than three seconds, cancelling the program.

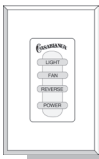





Inteli-Touch®

INTELI-TOUCH OPERATION LIGHT-MINDER PROGRAM

The Light-Minder program automatically turns OFF the fan mounted lights after two hours.

To enter the Light-Minder Program:

1. Turn the **POWER** OFF for at least three seconds.
2. Turn the **POWER** on.
3. Immediately operate the buttons in the following sequence:
 +  +  + 
4. A series of tones indicates this command has been accepted.



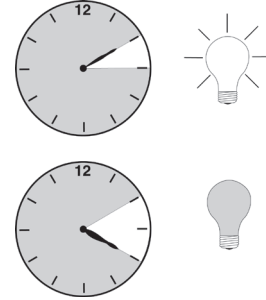

The fan and light will operate normally using the buttons to turn them on and off. But, if the lights are left on, they will automatically shut off after two hours. To cancel the Light-Minder Program, turn the **POWER** off for three seconds.



INTELI-TOUCH OPERATION SAFE-EXIT PROGRAM

The Safe-Exit Program gives you about thirty seconds of light when you turn the lights off, enabling you to exit your home before the lights go out.

To enter the Safe-Exit Program:

1. Turn the **POWER** off for at least three seconds.
2. Turn the **POWER** on.
3. Immediately operate the buttons in the following sequence:
 +  +  + 

After you hear the confirming audio tones from the fan - **immediately press**



4. The lights will blink to indicate this command has been accepted. The lights will stay on for twenty seconds and then begin to dim. After a total of thirty seconds has elapsed, the lights will be off completely. To cancel the Safe-Exit Program, turn the **POWER** off for three seconds.

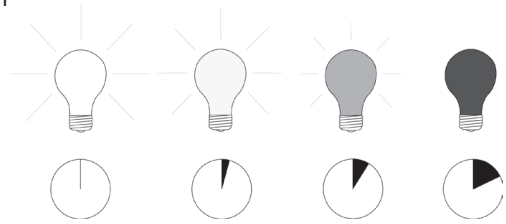





Note: Both Light-Minder and Safe-Exit programs can run at the same time, however the dimmer cannot be used, the light may only be turned ON/OFF.

INTELI-TOUCH OPERATION HOME-SAFE® PROGRAM

The Home-Safe Program makes an unoccupied home appear occupied by turning the lights on and off at random times.

To enter the Home-Safe Program:

1. Turn the **POWER** off for at least three seconds.
2. Turn the **POWER** on.
3. Immediately operate the buttons in the following sequence:
 +  +  + 
4. A tone and flashing light indicate this command has been accepted.

This program overrides all manual control of lights and fan. The lights will now be automatically cycled on and off in a controlled sequence as follows: On 1 hour, off 1/2 hour, on 2 hours, off 1 hour, on 1/2 hour then off 2 hours.

This seven hour pattern will repeat continuously so that a different pattern of lighting is seen each day of the week.





To cancel the Home-Safe Program, turn the **POWER** off for three seconds.



INTELI-TOUCH OPERATION FAN-MINDER® PROGRAM

The Fan-Minder feature will add to your comfort when used in the bedroom. The program reduces the speed of the fan each two-hour interval to compensate for the cooling night air.

To enter the Fan-Minder Program:

1. Turn the **POWER** off for at least three seconds.
2. Turn the **POWER** on.
3. Immediately operate the buttons in the following sequence:
 +  +  + 

4. The fan controller will respond with three descending tones. A timer is now initiated and the fan will reduce one speed for each two-hour interval. The fan will not, however, descend below the second lowest speed.

To cancel the Fan-Minder Program, turn the **POWER** off for three seconds. You may increase the fan speed by pressing and holding the  button until the desired speed is reached, then release it. The fan will again reduce one speed for each 2 hour interval.

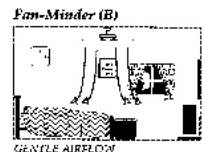

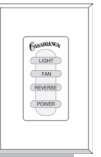

TROUBLESHOOTING

Before Requesting Service: Please follow this troubleshooting guide before contacting your dealer for assistance.

Caring for Finishes: For cleaning, a soft brush or lint-free cloth should be used to prevent scratching the finish. A vacuum cleaner brush nozzle can remove heavier dust. Surface smudges or an accumulation of dirt and dust can easily be removed by using a mild detergent and slightly dampened soft cloth. An antistatic agent may be used, but **never** use abrasive cleaning agents. These will damage the finish. Painted and high-gloss blades may be cleaned in the same manner.

Blades: Wood finish blades should be cleaned with a furniture polishing cloth. Occasionally, a light coat of furniture polish may be applied for added protection and beauty.

Never Lubricate this Fan!

The precision motor at the heart of your Casablanca fan features sealed bearings that are lubricated for life. Do not attempt to oil the motor.

Changing Light Bulbs

Be sure to turn power to the fan OFF at the wall switch or circuit breaker before changing light bulbs. Replace bulbs with same type as removed from the fixture. Each fan is rated for a maximum **TOTAL** wattage of lighting.

In compliance with US Federal Energy Regulations, this ceiling fan contains a device that restricts the light kit to a maximum of 190 watts. Exceeding that limit or the marked limit on this product may result in a fire hazard or improper operation.

PROBLEM	INTELI•TOUCH	POSSIBLE REMEDIES
---------	--------------	-------------------

NO FAN OR LIGHT	Check main circuit fuses, curcuit breakers, or wall switch position. Check all wire connections, making sure the power is turned off during this inspection.	
------------------------	--	--

FAN WOBBLER OR SHAKES EXCESSIVELY	Be sure canopy pin is properly set into the slot on the ball Check the screws holding the blade holders to the fan motor. Tighten as necessary. Check the angle of the blades to make sure that a blade holder has not been bent during installation.	
--	---	--

FAN NOISY DURING OPERATION	Check and tighten light fixture retaining screws, glass shade screws and/or the light bulb(s). Tighten canopy screws and mounting plate assembly. Tighten the blade to bladeholder screws and blade holders to flywheel. Make sure all screws in the motor housing are snug, but not overly tight. Check that the wire nuts inside the canopy and switch housing are not touching the metal parts or have fallen off the wire splices. Tighten or adjust as necessary.	
-----------------------------------	--	--

BREAK-IN PERIOD	Let fan run at high speed for two (2) hours	
------------------------	---	--

DOES NOT RUN ON LOW SPEED	If new, "break-in" may be required - run at higher speed for several days	
----------------------------------	---	--

LIGHTS FLASH OR BLINK DURING OPERATION OF W-32 WALL CONTROLS/FAN MAY ROTATE OR MAKE AUDIBLE TONES DURING OPERATION OF THE W-32 WALL CONTROLS: Normal operation.

WHEN AC POWER IS TURNED ON FOR THE FIRST TIME, THE LIGHTS OPERATE NORMALLY, BUT W-32 WALL CONTROL OPERATION IS REVERSED: FAN BUTTON OPERATES THE LIGHTS; LIGHT BUTTON OPERATES THE FAN: Reverse the 2 black and white striped wire connections.

FAN OR LIGHTS APPEAR TO OPERATE BY THEMSELVES (CHANGING SPEED OR INTENSITY), WALL CONTROL OPERATION IS INTERMITTENT: Check AC supply for irregularities, (noise spikes, fluctuations, or failure); or circuit board assembly.



SAFETY FIRST

Warning: To reduce the risk of electrical shock, this fan must be installed with an isolating wall control/switch.

ADVAN•TOUCH W-62 BRACKET/HOLSTER REMOVAL

Step 1. Remove the two 6-32 x 5/16" screws holding the bracket to the holster. Save screws for later.

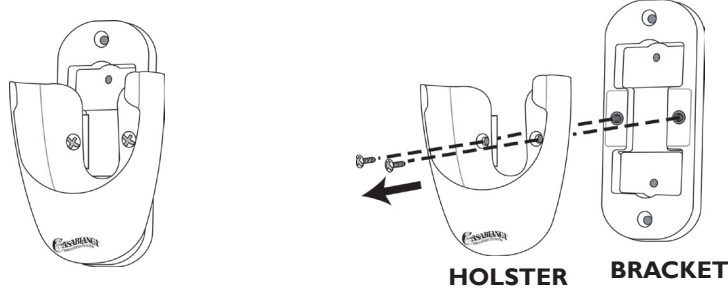

ADVAN•TOUCH CONTROL BRACKET INSTALLATION

CAUTION! Do not use with wall dimmer.

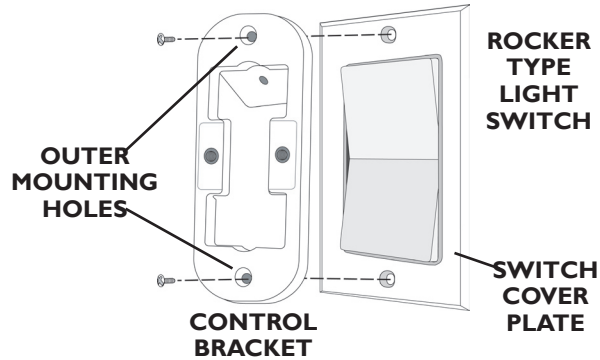
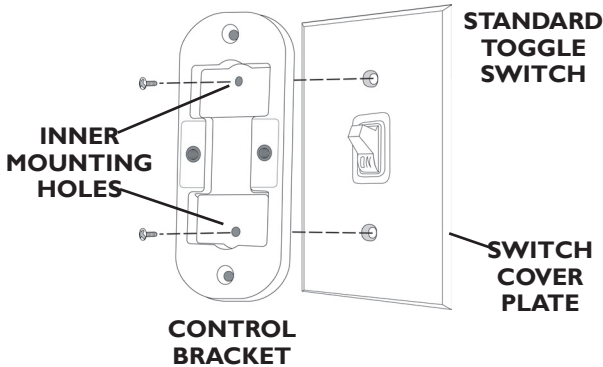

Standard Light Switch

Step A. Remove the two screws holding the switch cover plate. Do not remove the cover plate.
Step B. Orient the control bracket as shown and line up the two inner mounting holes with those on the switch.
Step C. Install and tighten screws by **hand** only.

Rocker Light Switch

Step A. Break off the two tabs by pushing outward.
Step B. Remove the two screws holding the switch cover plate. Do not remove the cover plate.
Step C. Orient the control bracket as shown and line up the two inner mounting holes with those on the switch.
Step D. Install and tighten screws by **hand** only.

Wall Installation

Step A. Locate a 2x4 wall stud in a convenient location.
Step B. Orient the control bracket as shown over the 2x4 stud.
Step C. Use the 1" wood screws in either the inner or outer mounting holes. Install and tighten screws by **hand** only.

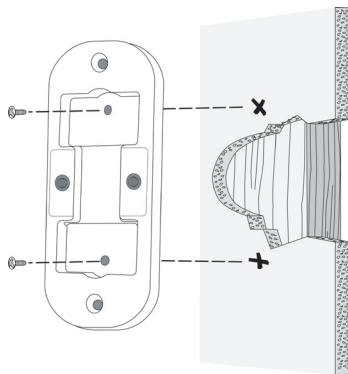

Note: The wall anchors and 6-32 x 1" screws may be used in situations where mounting to a stud is not possible. Use the inner mounting holes. After securing the anchor, discard the anchor's pointed screws and use the 6-32 decor ovalhead screws supplied.

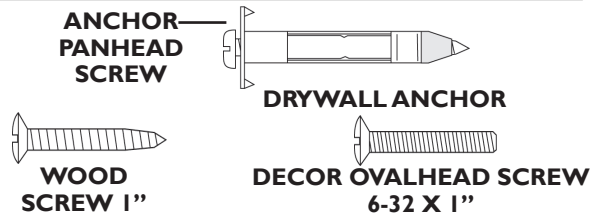

ADVAN•TOUCH ATTACH HOLSTER TO BRACKET

Step 2

After you have completed installing the bracket to the wall, using the 2 screws removed in Step 1, attach the W-62 holster to the bracket.



ADVAN•TOUCH BATTERY INSTALLATION

Open Battery Door by pressing down on the insert tab provided.

BATTERY DOOR

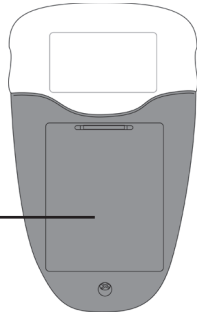

Install 4 “AAA” alkaline batteries in the space provided. Please observe proper polarity placement. Replace Battery Door.

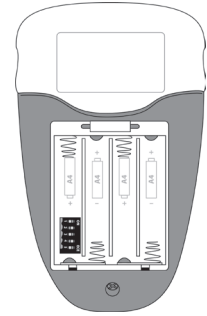

ADVAN•TOUCH IMPORTANT OPERATING NOTES

Power turned off, interrupted or failure:

The remote control is battery operated, therefore if the power is turned off, interrupted or you experience a power failure, the remote control remembers the previous setting for both fan and light.

Button operation:

Rapid button operation causes erratic fan operation.

For reliable operation of the remote control and fan you must wait one second between button presses to allow the radio signal to be transmitted to the fan and received.

ADVAN•TOUCH OPERATION

Fan Operation

The Advan•Touch fan is controlled by the remote control. The fan button located in the center top row, turns the fan on or off.

With the fan on, the control display will indicate an up or down moving arrow that shows direction and places a box around the operating speed. It will also show you a moving fan image that tells you the fan is on and what direction the blades are moving in (looking up from underneath the fan). Just below the fan button, there are two ▲ and ▼ buttons. Use the ▲ button (on the left) to increase fan speed once for each press and the ▼ button (on the right) to decrease speed once for each press.

Use the reverse button to change the direction of the rotation. Reverse operates at any speed. The fan returns to its set speed after reversing.

You will see the airflow direction arrow change each time to press reverse.

Light Operation

The light is turned on or off independently of the fan by pressing the LIGHT button. Keep pressing the button (hold it down) and it becomes a dimmer. The light varies from “bright” to “dim” over approximately 8 seconds. This sequence will reverse the light when it reaches the brightest or dimmest level if you continue to hold the LIGHT button. Release the button when the desired level is reached.

Safe Exit Feature

To turn off the light, hit the button once and the light will increase slightly if less than 100% and gradually turn off, taking approximately 20 seconds. (If set at 100%, light will decrease to about 50% and then gradually turn off.) This enables you to leave a room or your home safely before the lights go completely out.

Push the light button two times and the light will immediately dim to about half and then turn off completely.

The fan will remember the last light setting and will come on at that setting until charged.

Bulb Saver Feature

When the light is turned on, the brightness will take 1.5 seconds until it reaches the present level. This feature helps extend light bulb life.

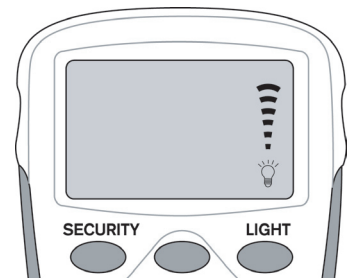
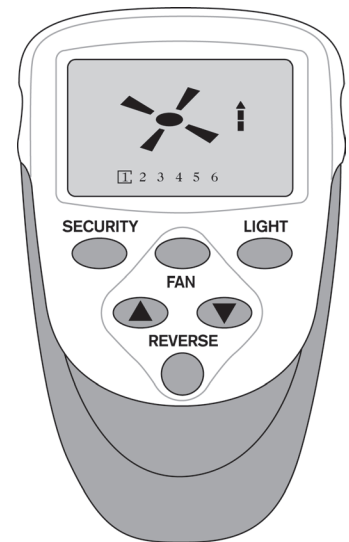



SECURITY FEATURE

Pressing the 'SECURITY' button will start the Security lighting program. The controller beeps and indicates 'SECURITY'. The light will automatically turn ON and OFF in a seemingly random manner over an eight and a quarter hour programmed cycle that is designed to give the home a "lived-in" look.

Regardless of the light setting when switching to the Security mode (lights on or off, dim or bright), the lights will increase to high brightness and then begin the Security cycle. This cycle is then repeated continuously until cancelled by pressing the 'SECURITY' button.

At any time during the Security mode you may adjust the fan speed, reverse the direction, operate in Auto Speed or Winter, use Saver or run the Test mode without affecting Security mode.

You may still turn the light ON and OFF (or OFF and ON) manually for temporary lighting, but the light will continue to operate automatically at its programmed times.

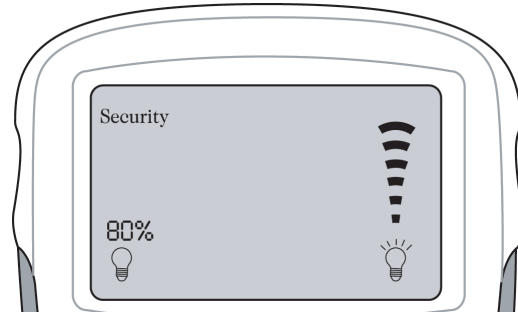

SECURITY MODE CYCLE

- | | |
|------------------------------------|-----------------------------------|
| 1. On for 60 minutes (80% bright) | 4. Off for 60 minutes |
| 2. Off for 30 minutes | 5. On for 90 minutes (50% bright) |
| 3. On for 120 minutes (30% bright) | 6. Off for 60 minutes |

ADVAN•TOUCH CHANGING FREQUENCY SETTING

Note: All fans leave the factory set to '10000'.

You will have to change the dip switch settings in the remote if you are using more than one fan in the same area and want to control them separately.

Step 1. At the circuit breaker or fusebox, turn the power off for the fan you want to change.

Step 2. Open the battery door of the Advan•Touch control and remove the first battery on the left to gain access to the dip switches.

Step 3. Change the dip switch settings, assuring that they are different from the previously installed Advan•Touch fan(s).

Step 4. Re-install the battery in the proper polarity and the battery door on the control.

Step 5. At the circuit breaker or fuse box, turn the power back on for the fan whose frequency you are changing.

Step 6. Within 20 seconds of restoring power, push the ▲ up and ▼ down buttons at the same time. Hold for a few seconds. You will see the LCD Screen flash all of the graphics. You should now have control of the fan.

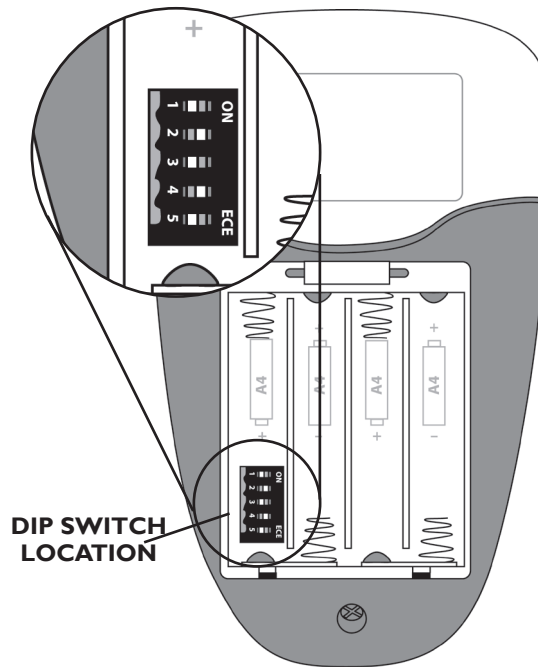

Note: You may want to label your controls to assure you do not mix them up.

ADVAN•TOUCH IF THE FAN DOES NOT WORK

If the fan is not functioning after installation:

Step 1. Check to make sure the batteries are installed properly in the control.

Step 2. Turn the power off to the fan (from the circuit breaker) for at least 5 seconds.

Step 3. Turn the power back on (at the circuit breaker) and push the ▲ up and ▼ down buttons at the same time, within 20 seconds from restoring power.

Step 4. The fan should now function properly.



TROUBLESHOOTING

Before Requesting Service: Please follow this troubleshooting guide before contacting your dealer for assistance.

Caring for Finishes: For cleaning, a soft brush or lint-free cloth should be used to prevent scratching the finish. A vacuum cleaner brush nozzle can remove heavier dust. Surface smudges or an accumulation of dirt and dust can easily be removed by using a mild detergent and slightly dampened soft cloth. An antistatic agent may be used, but **never** use abrasive cleaning agents. These will damage the finish. Painted and high-gloss blades may be cleaned in the same manner.

Blades: Wood finish blades should be cleaned with a furniture polishing cloth. Occasionally, a light coat of furniture polish may be applied for added protection and beauty.

Never Lubricate this Fan!

The precision motor at the heart of your Casablanca fan features sealed bearings that are lubricated for life. Do not attempt to oil the motor.

Changing Light Bulbs

Be sure to turn power to the fan OFF at the wall switch or circuit breaker before changing light bulbs. Replace bulbs with same type as removed from the fixture. Each fan is rated for a maximum **TOTAL** wattage of lighting.

In compliance with US Federal Energy Regulations, this ceiling fan contains a device that restricts the light kit to a maximum of 190 watts. Exceeding that limit or the marked limit on this product may result in a fire hazard or improper operation.

PROBLEM	ADVAN•TOUCH	POSSIBLE REMEDIES
---------	-------------	-------------------

FAN WILL NOT START	-Check main circuit fuses, circuit breakers, or wall switch position. Check all wire connections, making sure the power is turned off during this inspection. -Pin connectors are not making good contact. Check all connections. -Battery weak—install fresh battery. -Fan receiver defective—replace.	
---------------------------	--	--

FAN DOES NOT RESPOND TO REMOTE CONTROL	-Power to fan is off. -Wrong remote is being used. -Remote dip settings changed—see instructions for changing the frequency setting.	
---	--	--

FAN WOBBLER OR SHAKES EXCESSIVELY	-Be sure canopy pin is properly set into the slot on the ball. -Check that bladeholders have not been bent during installation and blades are balanced. -Hanger bracket and/or ceiling outlet are loosely attached: Make sure that the hanger bracket is tightly attached to the ceiling outlet box. Make sure that the downrod assembly is secured firmly. -Downrod is loosely attached to downrod base: Make sure that all screws are securely tightened.	
--	--	--

FAN NOISY DURING OPERATION	-Check and tighten light fixture retaining screws, glass shade screws and/or the light bulb(s). -Tighten canopy screws and mounting plate assembly. Check that the wire nuts inside the canopy and switch housing are not touching the metal parts or have fallen off the wire splices. Tighten as necessary. -Tighten blade holders to flywheel (or direct drive motor)/and blade to bladeholder screws. -Make sure all screws in the motor housing are snug, but not overly tight. Defective bulb: Replace bulb.	
-----------------------------------	---	--

DOES NOT RUN ON LOW SPEED	-If new, "break-in" may be required - run at higher speed for several days.	
----------------------------------	---	--

BATTERY LIFE SEEMS SHORT	-Not using Alkaline batteries: Replace with ALKALINE batteries.	
---------------------------------	---	--

FAN O.K., NO LIGHT: Check for burned out light bulb. Check fan light wires.

LIGHT O.K., NO FAN: Check connectors, may not be making good contact.

REMOTE CONTROL OF FAN IS ERRATIC: Check batteries installed correctly. Install fresh ALKALINE batteries.

FAN STARTS WORKING BY ITSELF: Frequency interference; Change dip switch code.

This device complies with RSS-210 of Industry Canada. Operation is subject to the following two conditions: (1) this device may not cause interference, and (2) this device must accept any interference, including interference that may cause undesired operation of the device.

1. This device complies with part 15 of the FCC Rules. Operation is subject to the following two conditions: (1) this device may not cause harmful interference, and (2) this device must accept any interference received, including interference that may cause undesired operation.

2. This equipment has been tested and found to comply with the limits for a Class B digital device, pursuant to Part 15 of the FCC Rules. These limits are designed to provide reasonable protection against harmful interference in a residential installation. This equipment generates, uses and can radiate radio frequency energy and, if not installed and used in accordance with the instructions, may cause harmful interference to radio communications. However there is no guarantee that interference will not occur in a particular installation. If this equipment does cause harmful interference to radio or television reception, which can be determined by turning the equipment off and on, the user is encouraged to try to correct the interference by one or more of the following measures: Reorient or relocate the receiving antenna, Increase the separation between the equipment and receiver, Connect the equipment into an outlet on a circuit different from that to which the receiver is connected. Consult the dealer or an experienced radio/TV technician for help. Note: Any changes or modifications to the transmitter or receiver not expressly approved by Casablanca Fan Company may void one's authority to operate this remote control.

PRODUCT SPECIFICATIONS

Model Name: Stealth[®]
Model Number: 32xxA/T

Dimensions:
A = 10.8"
B = 13.25"
C = 3"
D = 11.5"
E = 5.6"

NOTE: Dimension B includes light fixture and glass.

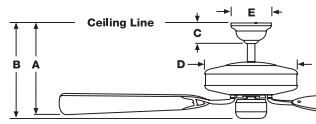

Weight: 33 lbs.

Motor: XLP-2000[®]
Blade Span: 54"
Blade Iron Pitch: 14°
No. of Blades: 5
Technology: Advan•Touch[®] W-62
Inteli•Touch[®] W-32
Lightbulb: (1) 100-watt halogen lightbulb

Airflow: 6,251 cfm
Electricity Use*: 112 watts
Airflow Efficiency*: 52.9 cfm/watt

* Performance data is for fan only. No lighting wattage is included.