

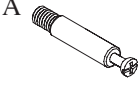





TUN010CL	TUN011KC		TUN021AG	TUN013LB	TUN014SC	TUN015BG
						
Cam Lock 12Pcs	Klix Cam 12Pcs	Dowel 10Pcs	Adjustable Glide 4Pcs	I-Bracket 2Pcs	Screw M6 x 20 12Pcs	Cam Cover 12Pcs

### STEP 1



COMPLETED ASSEMBLY

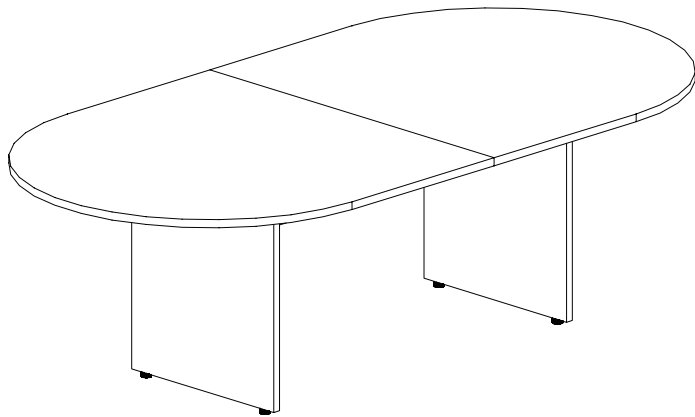
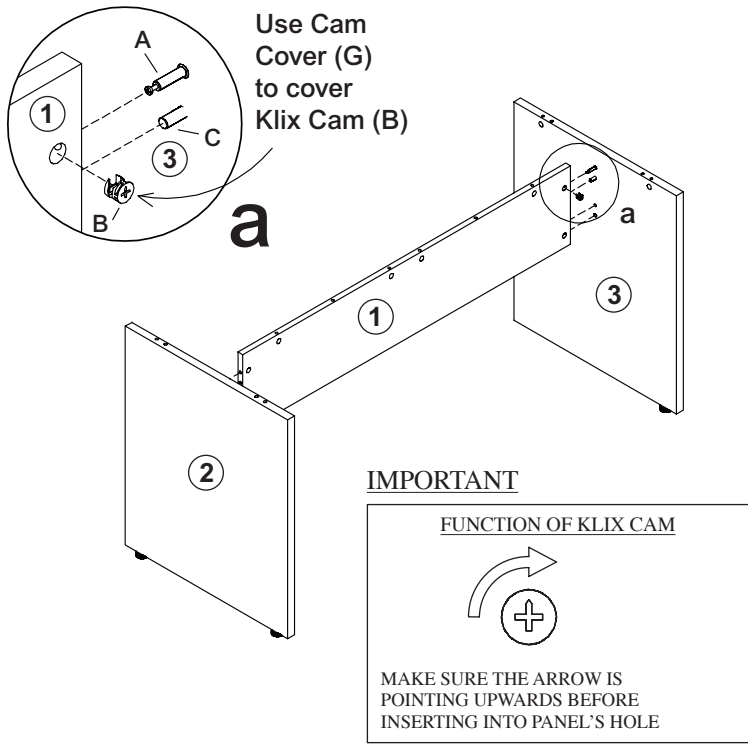

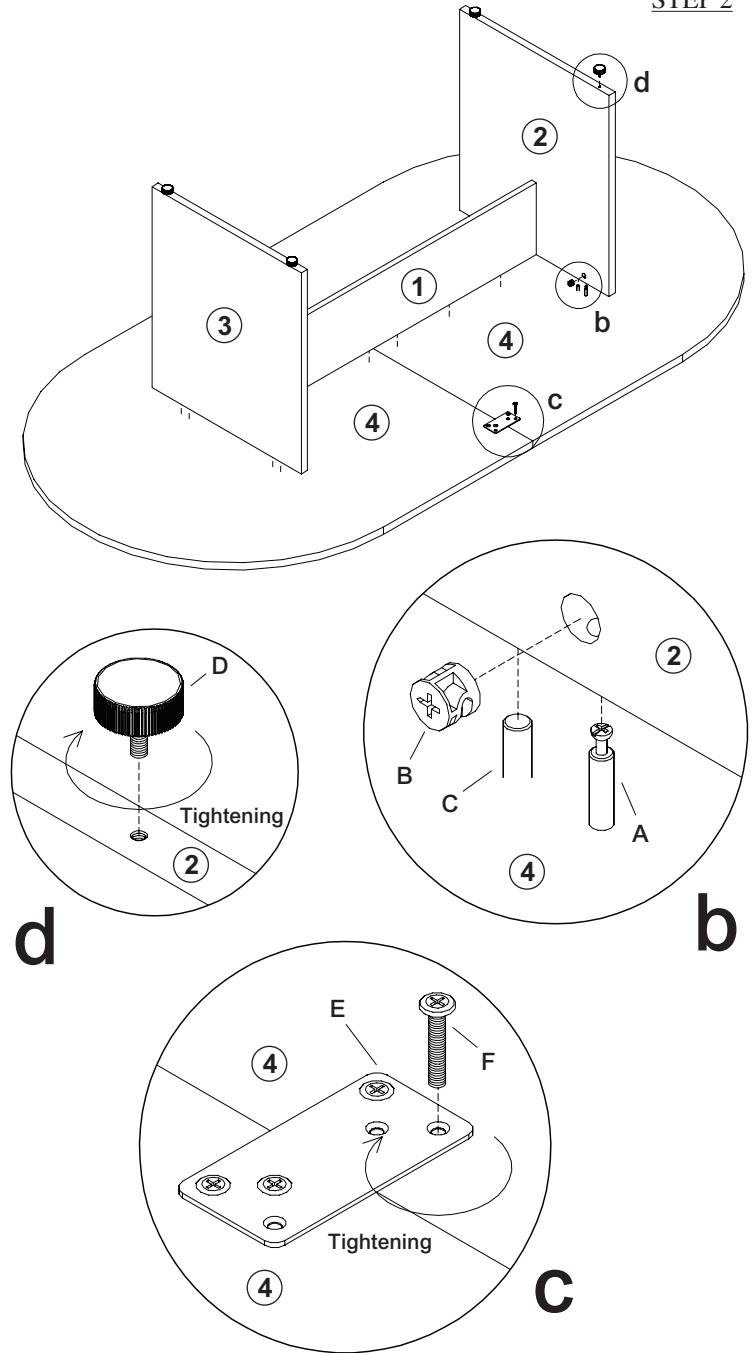



### STEP 2

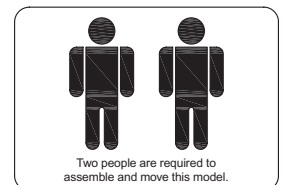

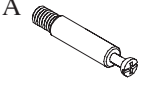
### IMPORTANT NOTE:

- Place all laminated parts on a clean and smooth surface such as a rug or carpet to avoid the parts from being scratched.
- Check to be sure that you have all parts and hardware.
- Remove all wrapping materials, including staples and packing straps before you start to assemble.
- Don't tighten all screws/bolts until all completely assembled.
- Keep all hardware parts out of reach of children.
- It is recommended for 2 persons to complete this assembly.



TUN010CL	TUN011KC		TUN021AG	TUN013LB	TUN014SC	TUN015BG
						
Verrou à came 12mex	Came Klix 12mex	Cheville 10mex	Patin ajustable 4mex	I-Support 2mex	Vis M6 x 20 12mex	Couvercle de came 12mex

**ÉTAPE 1**

Utilisez le couvercle de came (G) pour couvrir la came Klix (B)

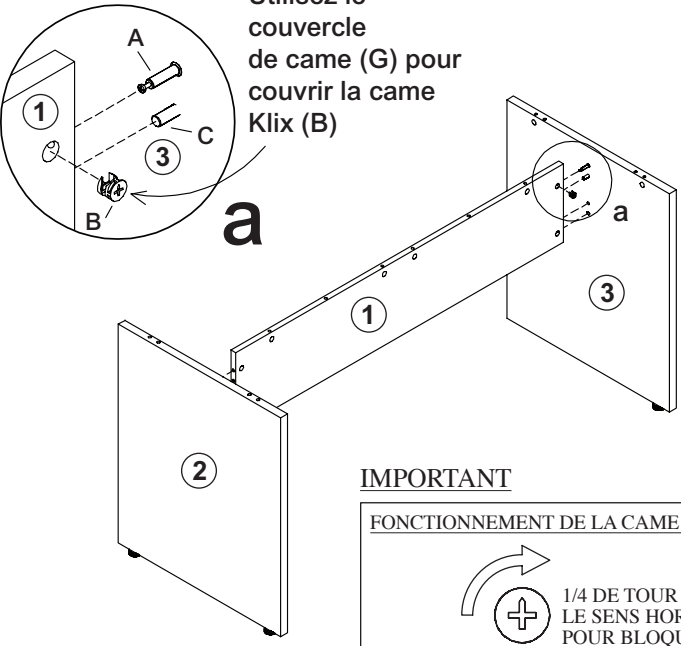

**IMPORTANT**

**FONCTIONNEMENT DE LA CAME KLIX**



1/4 DE TOUR DANS LE SENS HORAIRE POUR BLOQUER

ASSUREZ-VOUS QUE LA FLÈCHE POINTE VERS LE HAUT AVANT L'INSERTION DANS LE TROU DU PANNEAU.

**ÉTAPE 2**

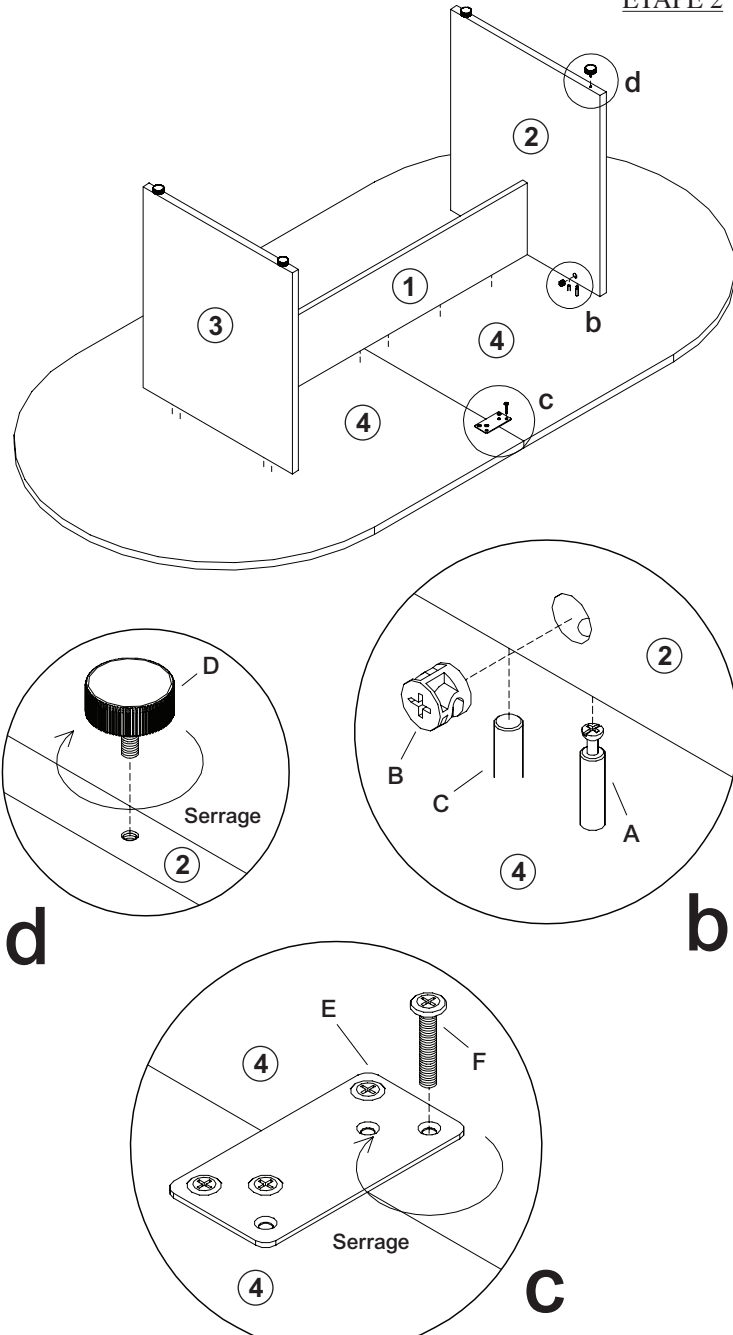

**d**

**b**

**c**

**a**

**C**

Serrage

Serrage

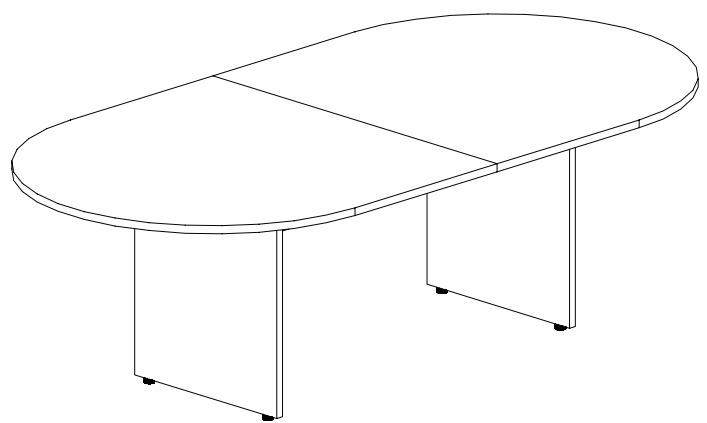





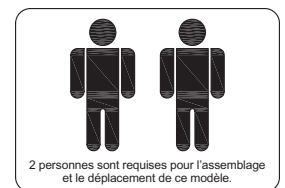

**ASSEMBLAGE COMPLÉTÉ**

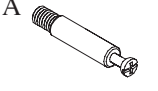
**NOTE IMPORTANTE :**

- Déposez toutes les pièces laminées sur une surface propre et douce comme sur une carpepe ou un tapis afin d'éviter l'éraflure des pièces.
- Vérifiez pour vous assurer que vous avez toutes les pièces et toute la quincaillerie.
- Enlevez tout le matériel d'emballage, incluant les agrafes et les courroies d'empaquetage avant de débuter l'assemblage.
- Ne serrez pas aucun des boulons/vis avant d'avoir assemblé toutes les pièces.
- Gardez toutes les pièces de quincaillerie hors de portée des enfants.
- Il est recommandé que 2 personnes effectuent cet assemblage.



TUN010CL	TUN011KC		TUN021AG		TUN014SC	TUN015BG
						
Seguro de ajuste 12 pzas.	Leva 12 pzas.	Taquete 10 pzas.	Riel ajustable 4 pzas.	Soporte I 2 pzas.	Tornillo M6 x 20 12 pzas.	Cubierta de levas 12 pzas.

Use la Cubierta de levas (G) para cubrir la Leva (B)

**IMPORTANTE:**

**FUNCIONAMIENTO DE LAS LEVAS**

GIRE 1/4 DE VUELTA A LA DERECHA PARA CERRAR.

ASEGÚRESE DE QUE LA FLECHA APUNTA HACIA ARRIBA ANTES DE INSERTARLA EN EL ORIFICIO DEL TABLERO.

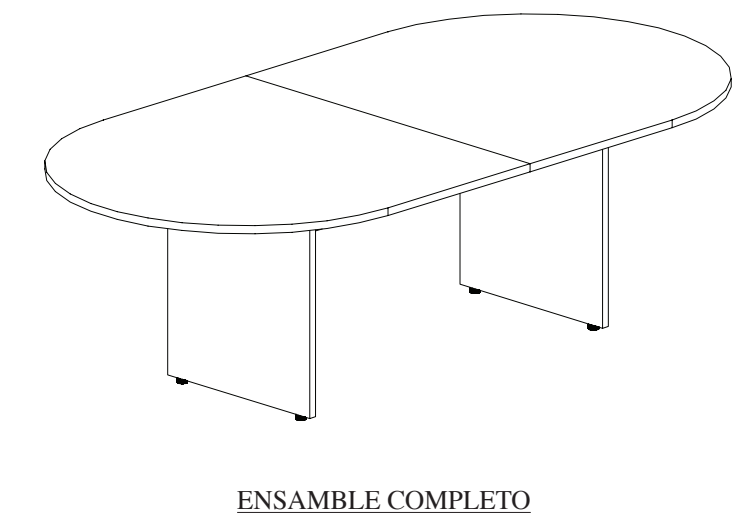

**PASO 2**

**d**

**b**

**c**

**C**

Apriete

Apriete

**NOTA IMPORTANTE:**

- Coloque todas las partes laminadas sobre una superficie limpia y uniforme (como un tapete o la alfombra) para evitar que se rayen.
- Asegúrese de tener todas las partes y la ferretería.
- Antes de empezar a ensamblar remueva todos los materiales de empaque, incluyendo grapas y cintas.
- No apriete todos los tornillos o pernos hasta haber ensamblado todas las piezas.
- Mantenga toda la ferretería fuera del alcance de los niños.
- Se recomienda que dos personas realicen este ensamble.



## **Instructions**

If you are missing parts or have other concerns, please email [Lorell@sprich.com](mailto:Lorell@sprich.com) or fax: 404-472-9063. Please provide the following information:

1. Full Name
2. Physical Address – do not include P.O. Box as our carriers cannot deliver to a P.O. Boxes
3. Phone Number
4. Model Number
5. Part Number
6. Invoice #
7. Date of Purchase

Note: Our policy is to send all parts requests normal ground transportation, if your requirements are to have these parts via overnight/next day, please provide your designated carrier and account number. Replacement panels are not available. If damaged has occurred during shipment, please return the entire unit to place of purchase for credit and replacement. Original Invoice may be required.

Before you begin:

Open, identify and count all parts prior to assembly. Lay out the parts on a non-abrasive surface such as carpet or blanket.

## **Instructions**

Veillez nous faire parvenir un courriel à [lorell@sprich.com](mailto:lorell@sprich.com) ou un fax à : 404-472-9063, s'il vous manque des pièces ou que vous éprouvez d'autres inquiétudes.

Veillez fournir l'information suivante :

1. Nom complet
2. Adresse physique – ne donnez pas votre boîte postale car nos livreurs ne peuvent pas livrer à une boîte postale
3. Numéro de téléphone
4. Numéro de modèle
5. Numéro de pièce
6. # de facture
7. Date de l'achat

Note: Notre politique est de livrer toutes les demandes de pièces par la voie terrestre; prière de fournir le nom de votre transporteur ainsi que votre numéro de compte si vos exigences sont d'avoir ces pièces livrées pendant la nuit/le lendemain. Des panneaux de remplacement ne sont pas disponibles. Si des dommages sont survenus durant le transport, prière de retourner l'unité entière à l'endroit de l'achat pour un crédit et un remplacement. La facture originale peut être exigée.

Avant de commencer:

Ouvrez, identifiez et comptez toutes les pièces avant de procéder à l'assemblage. Disposez les pièces sur une surface non-abrasive telle un tapis ou une couverture.

## **Instrucciones**

Si le faltan partes o tiene alguna pregunta, escriba un mensaje de correo electrónico a [Lorell@sprich.com](mailto:Lorell@sprich.com) o envíe un fax al 404-472-9063.

Recuerde incluir la siguiente información:

1. Nombre completo
2. Domicilio. No incluye apartado postal debido a que nuestros distribuidores no pueden hacer entregas a un apartado postal.
3. Número telefónico
4. Número de modelo
5. Número de parte
6. No. de factura
7. Fecha de compra

Nota: Nuestra política establece enviar todas las partes solicitadas vía terrestre. Si sus requisitos incluyen tener estas partes con un envío nocturno o al día siguiente, sírvase proporcionar su transportista asignado y número de cuenta.

No se cuenta con tableros de repuesto. Si la unidad sufrió algún daño durante el envío, regrésela completa a donde la adquirió para que le reembolsen su pago y se la reemplacen. Se le podría solicitar su factura original.

Antes de iniciar:

Abra, identifique y cuente todas las partes antes del ensamble. Coloque todas las partes en una superficie no abrasiva, como una alfombra o sábana.