

Ulti MATE



GARAGE



BASE CABINET
Model Number # GA-02

Heavy Duty, Single Door, Single Shelf Base Cabinet

PLEASE DO NOT TAKE THIS PRODUCT BACK TO THE STORE!

Most likely, stores do not stock spare parts and cannot help. In the event that parts are missing.

PLEASE CALL: 800-344-7005

ASSEMBLY INSTRUCTIONS

Bladez Corp. | Ultimate Garage - 20155 Ellipse - Foothill Ranch, CA 92610
949.206.8155 (V) - 949.206.0013 (F)

PARTS LIST

Ulti MATE



BASE CABINET MODEL #GA-02

Using the Parts List below, check to make sure all parts are included. Instructions will reference Part Letters found in this list. In the event that parts are missing or damaged.

PLEASE CALL: 800-344-7005

**TOOLS NEEDED
FOR ASSEMBLY**

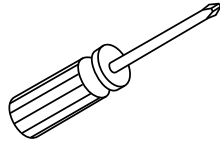



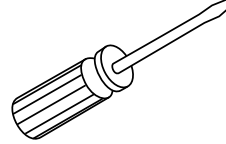

Phillips Screw Driver

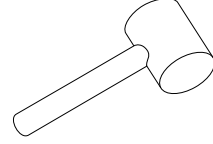



Flat Screw Driver



Rubber Mallet

#	DESCRIPTION	QTY	IMAGE
a	Side Panel (RIGHT)	1	
b	Side Panel (Left)	1	
c	Bottom Panel	1	
d	Back Panel	1	

#	DESCRIPTION	QTY	IMAGE
e	Top Work Surface	1	
f	Door	1	
g	Shelf	1	









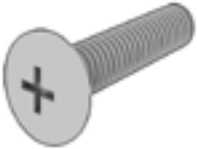
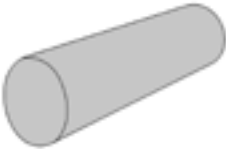

PARTS LIST Uti MATE

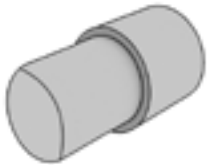

BASE CABINET MODEL #GA-02

Using the Parts List below, check to make sure all parts are included. Instructions will reference Part Letters found in this list. In the event that parts are missing or damaged.

PLEASE CALL: 800-344-7005

#	DESCRIPTION	QTY	IMAGE	#	DESCRIPTION	QTY	IMAGE
aa	Screw (4.5 x 42mm)	4		gg	Screw (M5 x 15mm)	2	
bb	Wooden Dowel	4		hh	Hinge	2	
cc	Cam	4		ii	Screw (3.5 x 12mm)	12	
dd	Metal Dowel	4		jj	Shelf Pin	4	
ee	Foot	4		kk	Spring Washer	2	
ff	Pull	1		ll	Corner Support	4	
				mm	Screw	4	
				nn	Touch-up Paint	1	

BEFORE YOU BEGIN

CAM STYLE FASTENERS ARE USED THROUGHOUT THE ASSEMBLY OF THIS CABINET. ASSEMBLE ALL CAMS AS SHOWN BELOW.

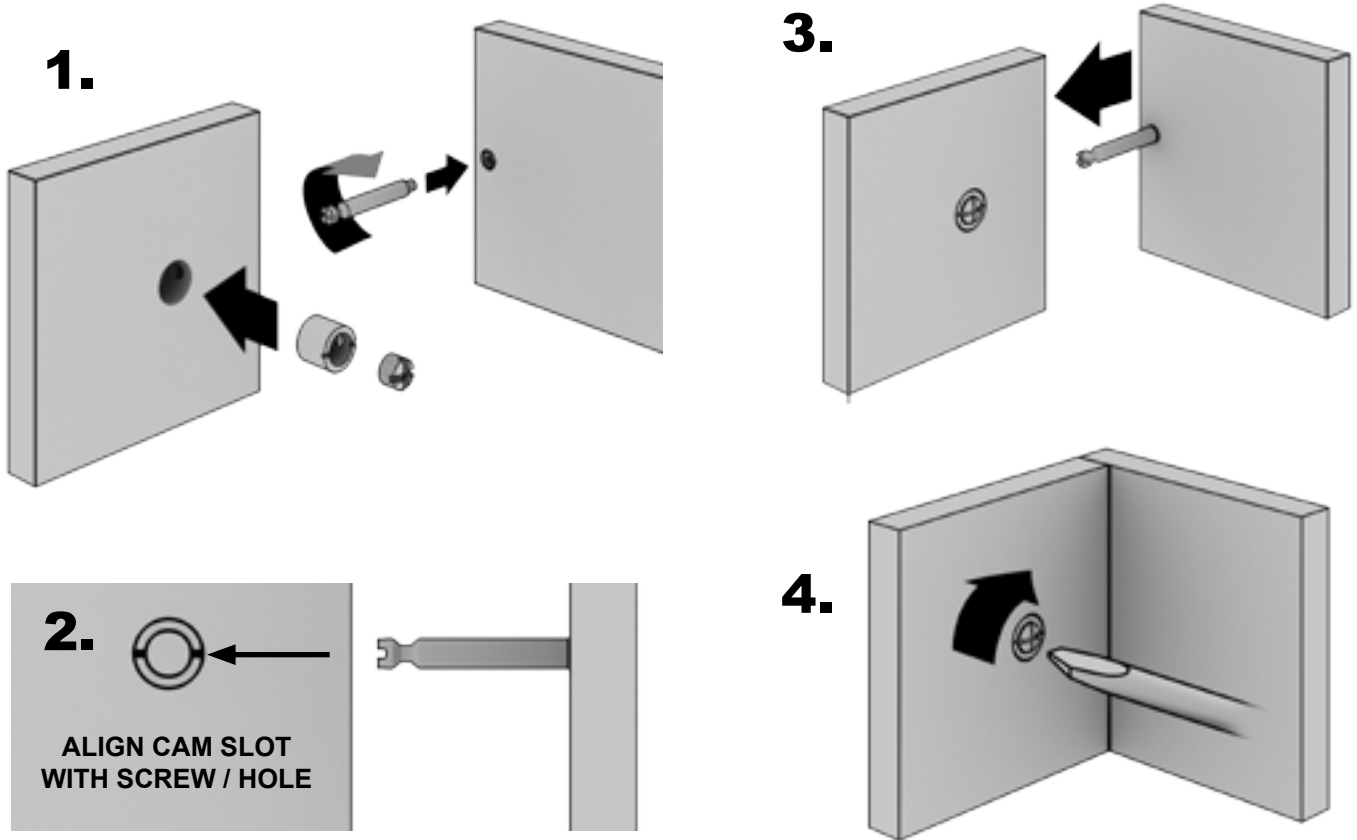

WHEN YOU FINISH

ADDING CORNER SUPPORTS TO THE BACK WILL GREATLY INCREASE THE STRENGTH OF YOUR CABINET.

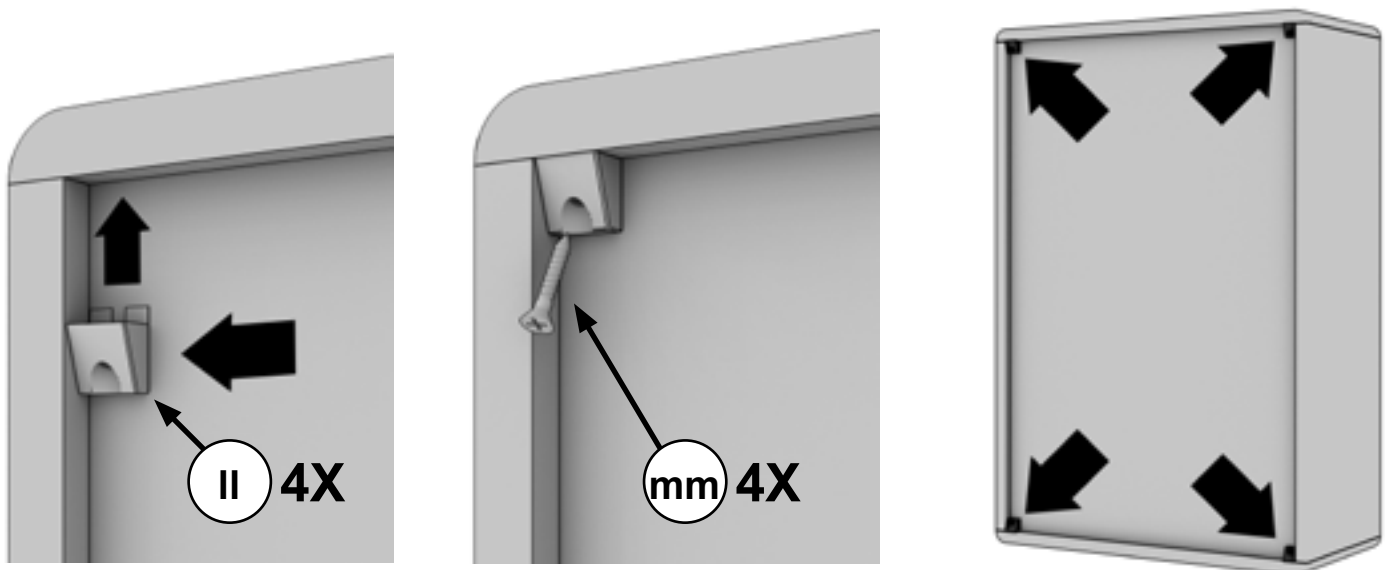

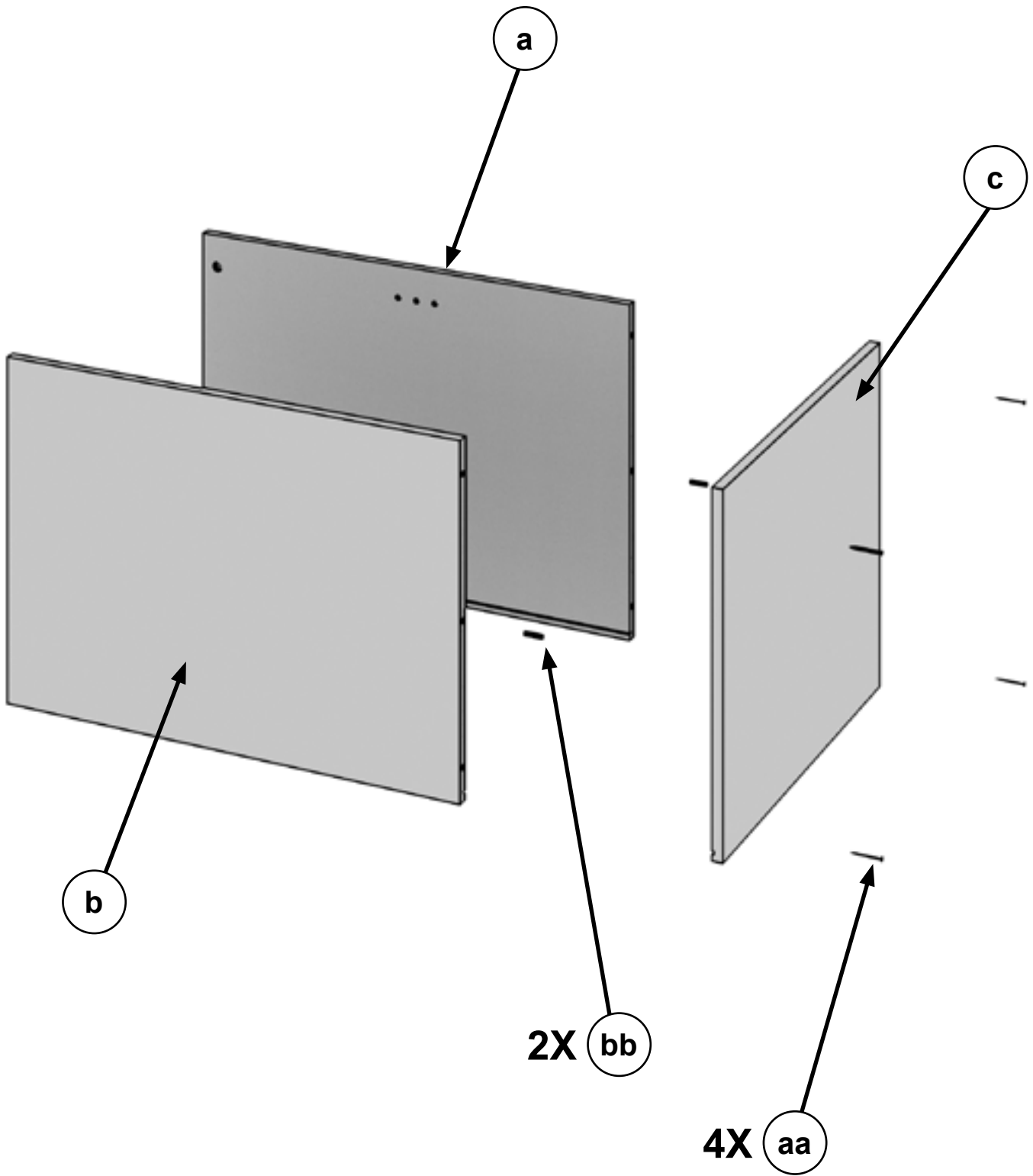

STEP 2

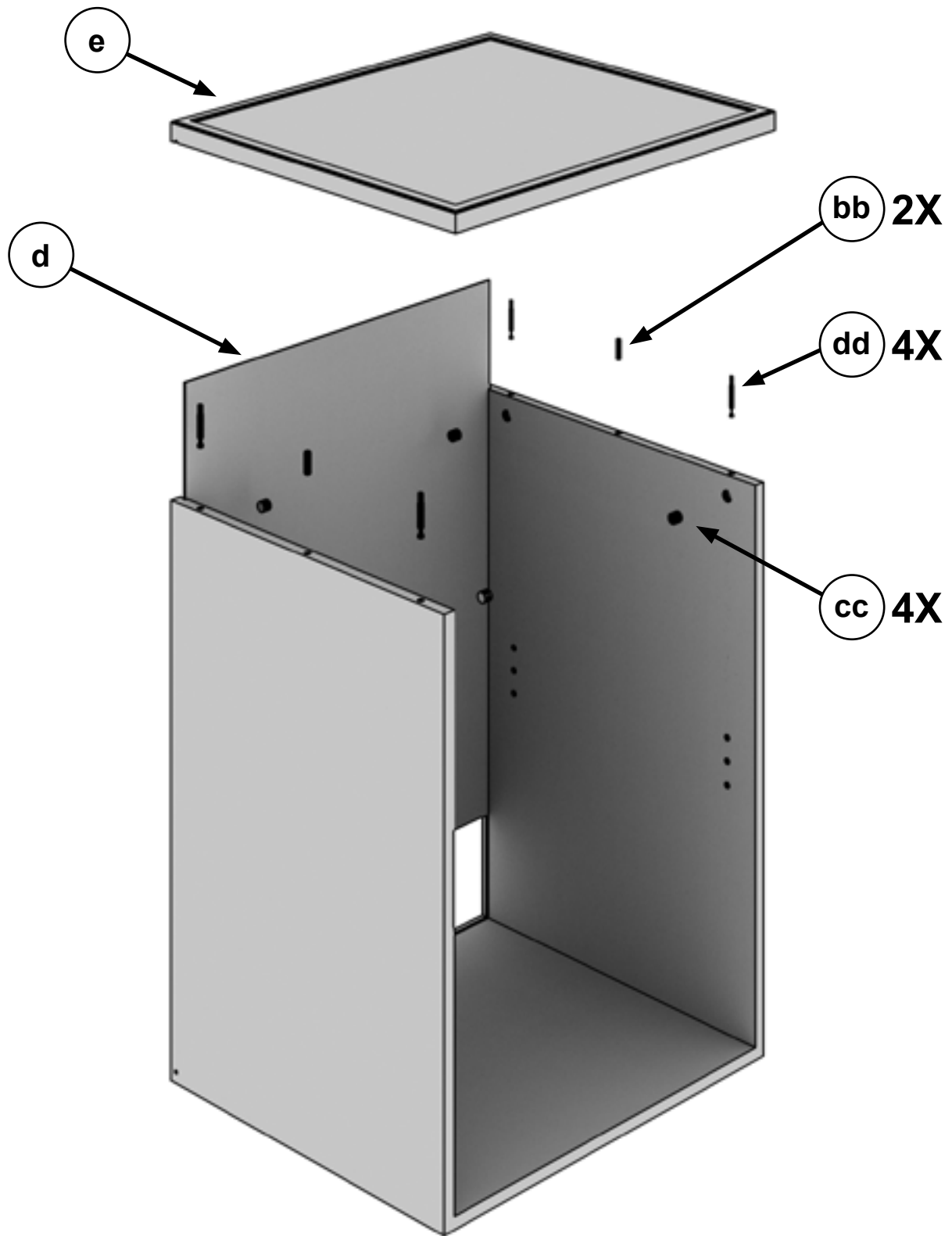

STEP 3

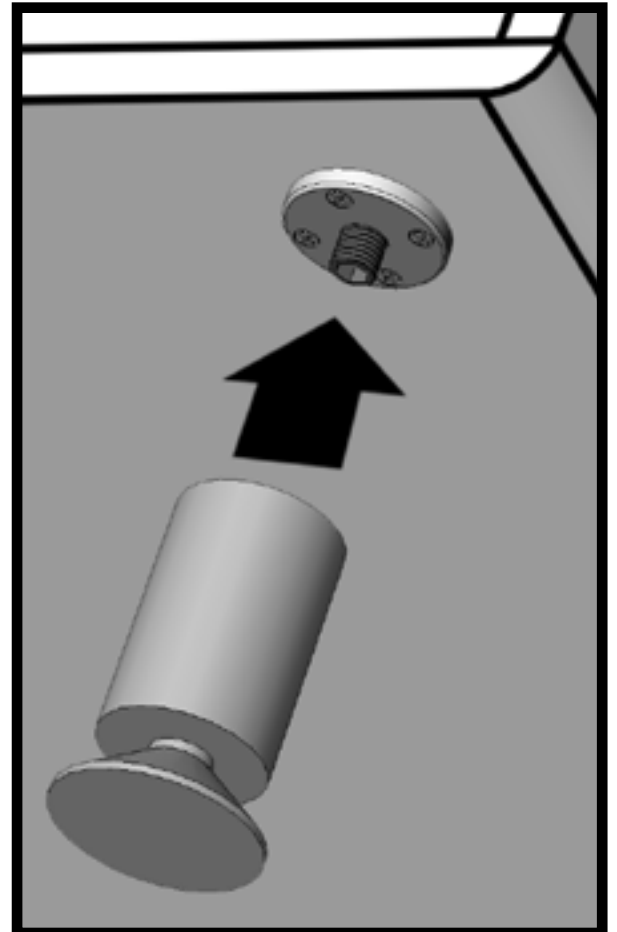
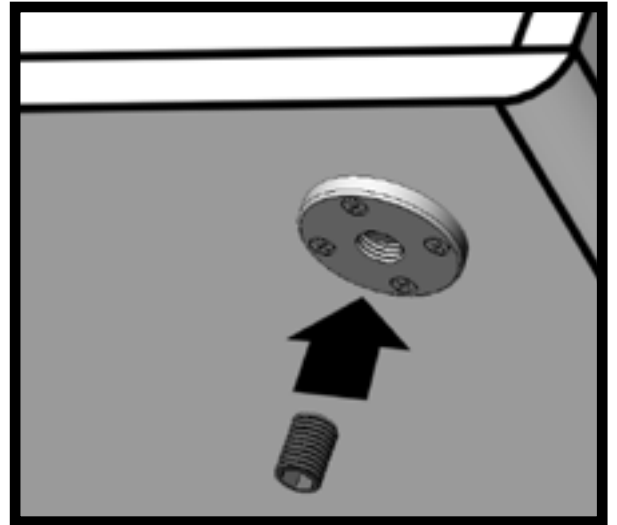
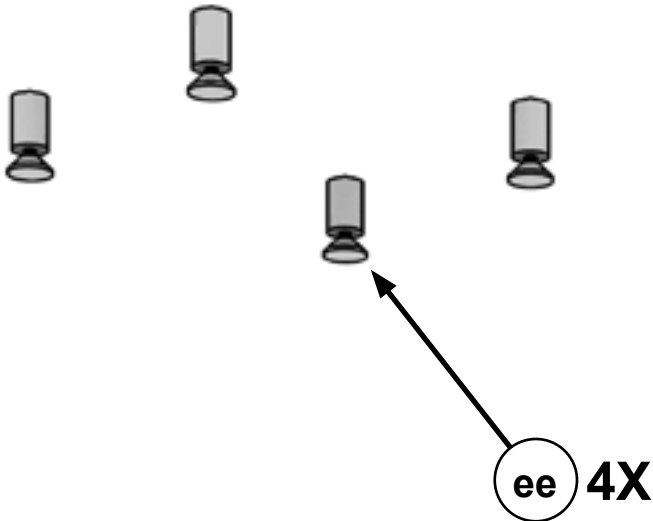
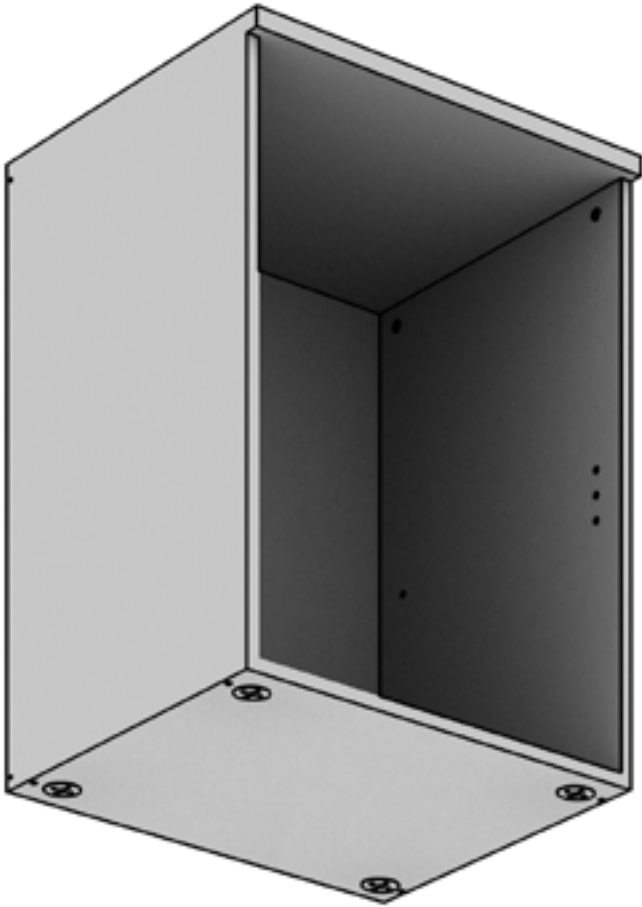

STEP 4

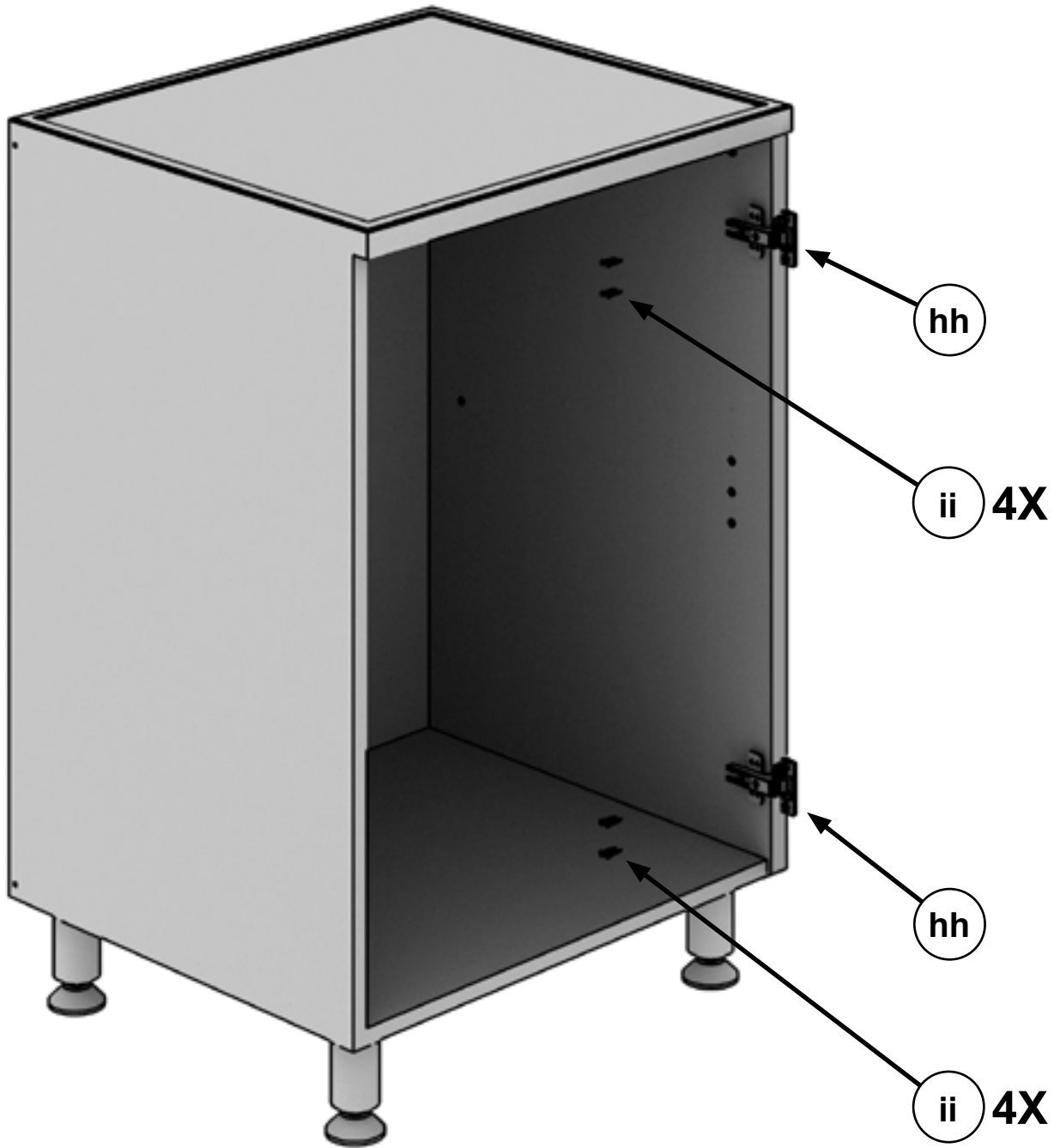

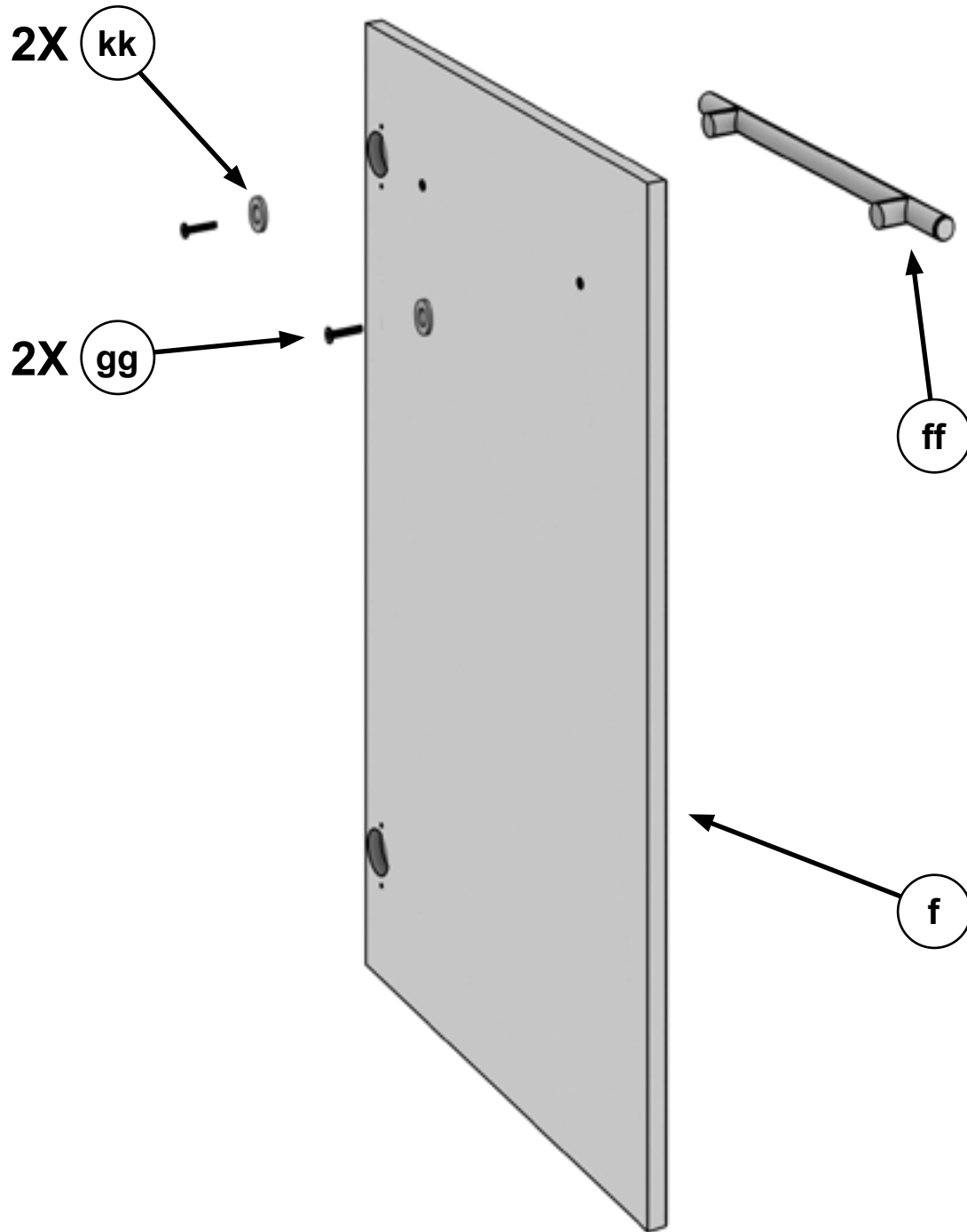

STEP 6

