

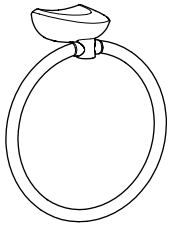

## HANSAMOTION

Montage- und Bedienungsanleitung • Mounting- and operating instructions • Instructions de montage et d'utilisation  
Istruzioni di montaggio e d'uso • Montage- en bedieningshandleiding • Montasje- og betjeninganvisning  
Instrucciones de montaje y de uso • Instruções de montagem e de uso



5371

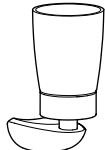

5372



5373

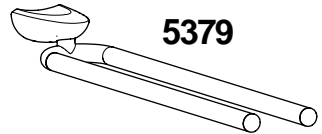

5379



5374



5378

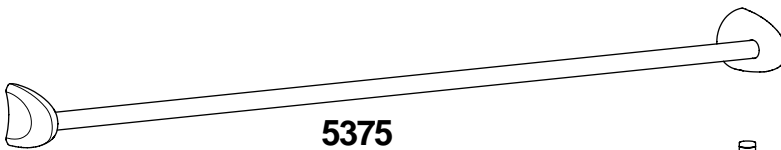

5375

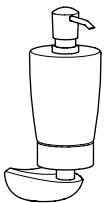

5382

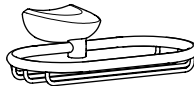

5383



5376



5377

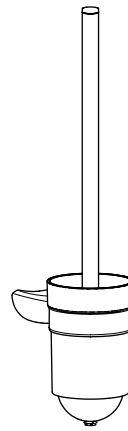

5381

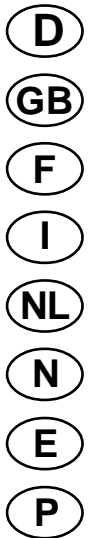

A017633/0505

**HANSA Metallwerke AG**

P. O. BOX 81 02 40 • D-70519 STUTTGART  
SIGMARINGER STRASSE 107 • D-70567 STUTTGART  
PHONE: (0711) 16 14 - 0 • TELEFAX (0711) 16 14 - 368  
info@hansa.de/www.hansa.de



**HANSA Produkte sind ausschließlich durch einen sanitären Fachhandwerker zu montieren.**

HANSA products may only be fitted by a qualified plumber.

Les produits HANSA doivent être montés exclusivement par un artisan spécialisé en sanitaires.

I prodotti HANSA devono essere montati esclusivamente da parte di un installatore specializzato in sanitari.

HANSA-producten mogen uitsluitend door een ambachtsman uit het sanitairbereik gemonteerd worden.

HANSA produkter skal kun monteres av en kvalifisert håndverker innen sanitæranlegg.

Los productos HANSA deben ser montados exclusivamente por un técnico especialista en instalaciones sanitarias

Os produtos HANSA deverão ser montados unicamente por canalizadores especializados.

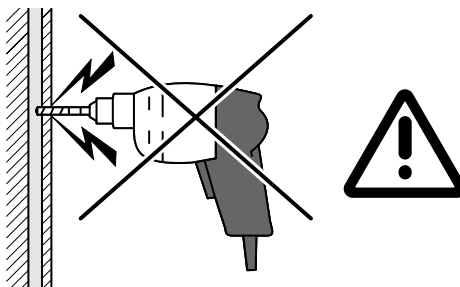

**Achtung Vergewissern Sie sich vor dem Bohren, dass sich an den Bohrstellen keine Hausinstallation befindet. Bei Beschädigung von Gas-, Strom-, Wasser- und Abwasserleitungen kann Lebensgefahr oder Sachschaden entstehen.**

- Warning** Ensure before drilling that there are no domestic services located where you are drilling. If gas, electric, water and effluent pipelines are damaged, this can endanger life or cause damage to property.
- Attention** Assurez-vous avant de forer qu'il n'y a pas d'installation domestique à l'endroit des points de forage. Danger de mort ou de dommages matériels en cas de détérioration de conduites de gaz, d'électricité, d'eau ou d'eaux usées.
- Attenzione** Prima di praticare i fori, è necessario accertarsi che sotto i punti previsti non si trovino alcune linee dell'installazione domestica. In caso di un danneggiamento delle condotte del gas, delle linee elettriche, dell'acqua o di scarico, può persistere un imminente pericolo di morte o di danni materiali.
- Opgelet** Controleer voor het boren of zich bij de boorplaatsen geen huisinstallatie bevindt. Bij beschadiging van gas-, stroom-, water- en rioolleidingen kan levensgevaar of schade ontstaan.
- OBS** Før du borer, må du forvise deg om at det ikke befinner seg husinstallasjoner i borepunktene. Ved skader på gass-, strøm-, vann- og avløpsledninger kan det oppstå livsfare eller materielle skader.
- Atención** Antes de taladrar, asegúrese de que no hay ninguna instalación doméstica en los puntos de perforación. Peligro de muerte o de daños materiales en caso de dañarse los conductos de gas, electricidad, agua y desagüe.
- Atenção!** Antes de começar a furar a parede, certifique-se de que não existe no ponto pretendido qualquer instalação. Se forem danificados condutores eléctricos ou então canalizações de gás, água ou esgotos poderão daí resultar danos materiais ou até mesmo perigo de vida.

**Einbaumaße**

Installation dimensions

Dimensions d'encastrement

Dimensioni d'ingombro

Inbouwmaten

Byggemål

Dimensiones de instalación

Dimensões de instalação

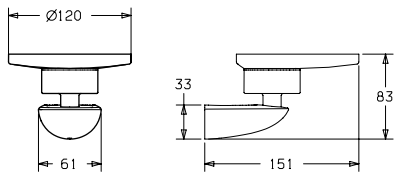
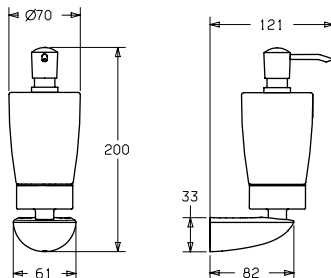
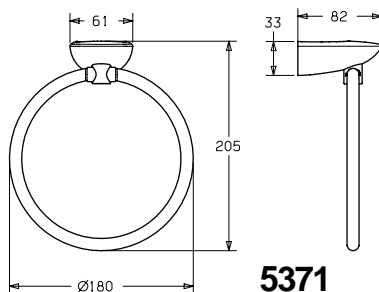
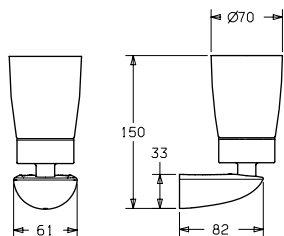
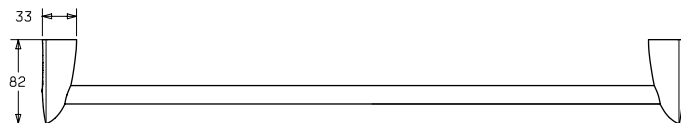
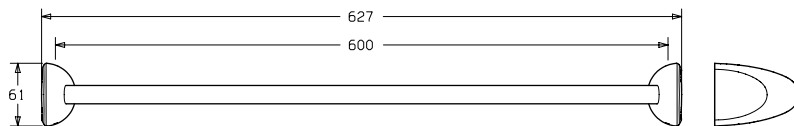
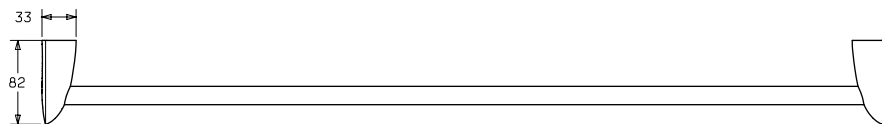
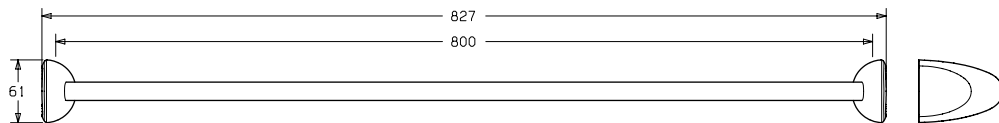
**3****5373****5382****5372****5371****5374****5375**

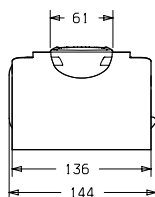

**5376**

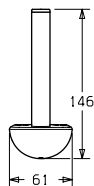
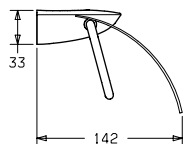

**5377**

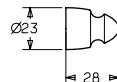
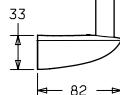

**5378**

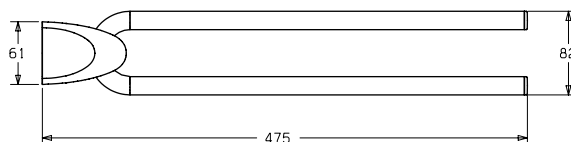

**5379**

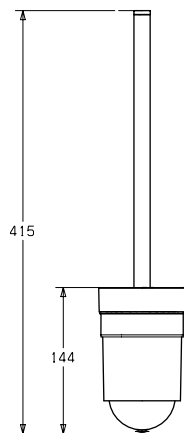
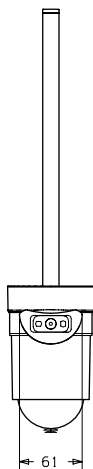

**5381**

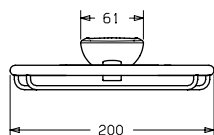
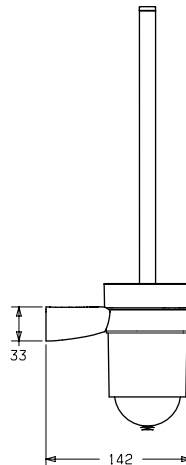

**5383**

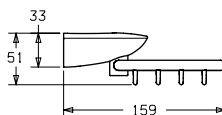

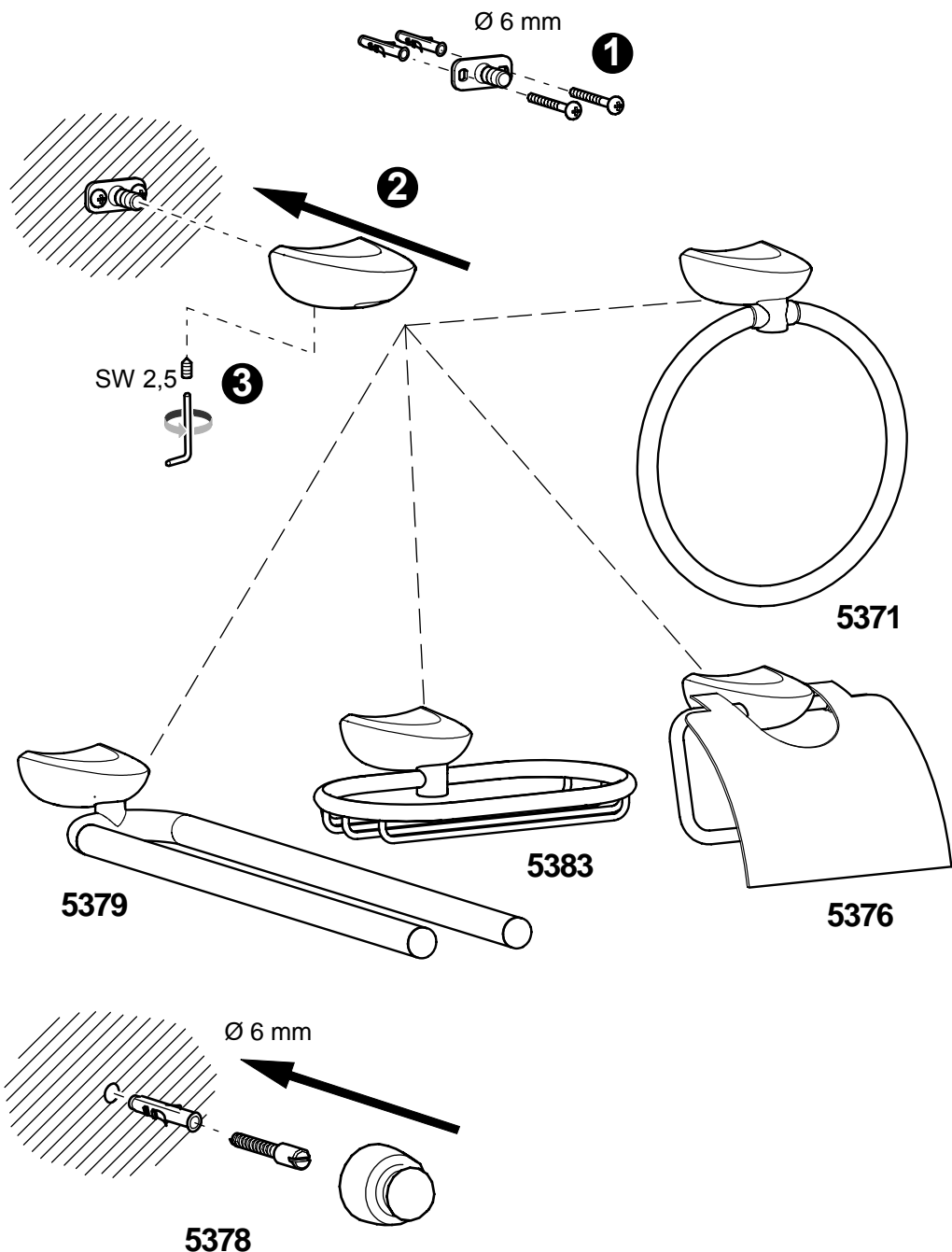

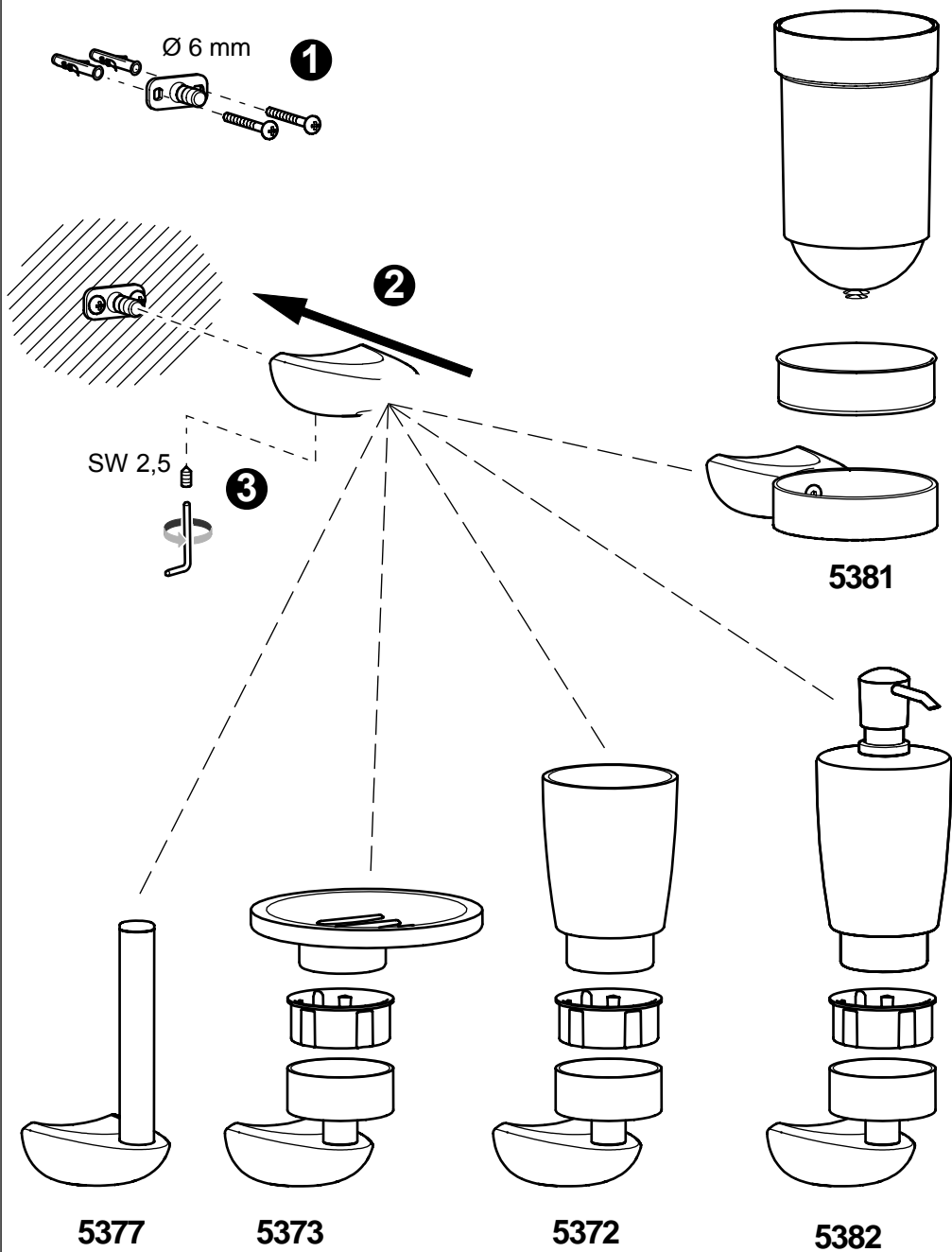

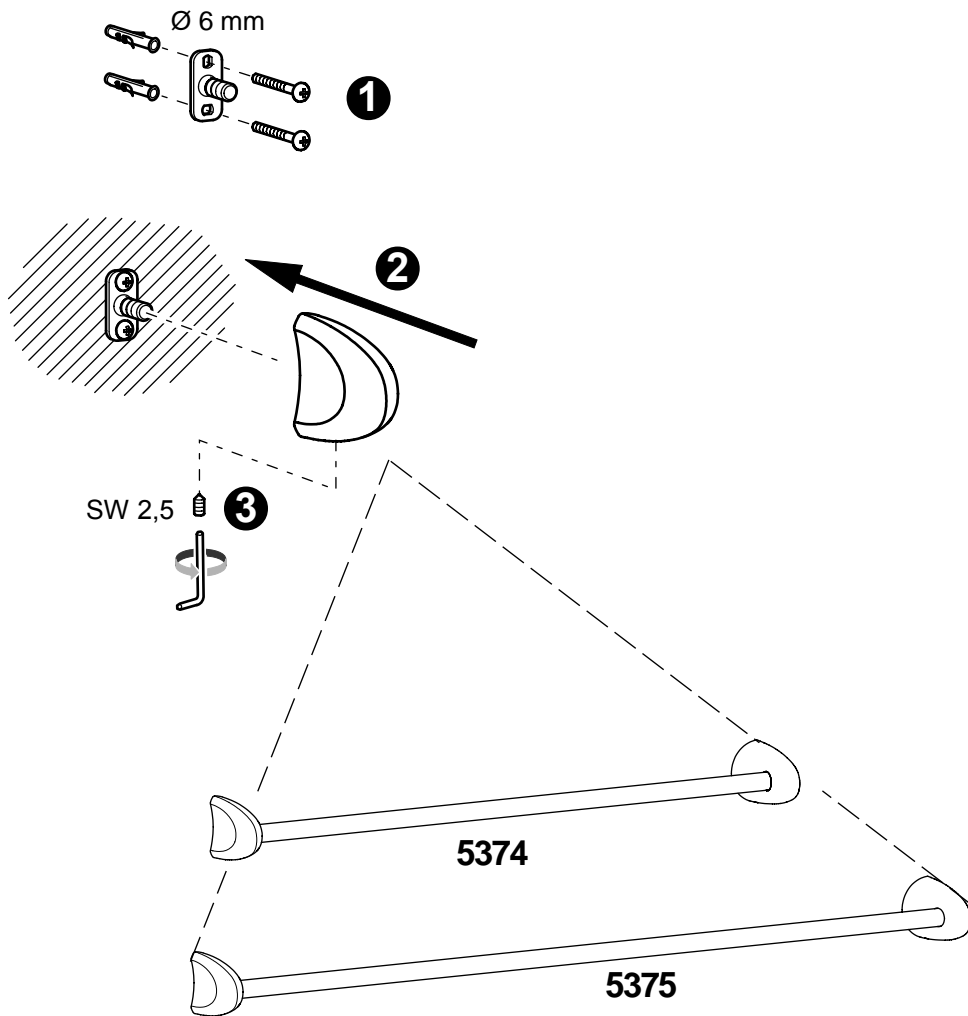

**Technische Änderungen vorbehalten**  
Subject to technical alteration  
Sous réserve de modifications techniques  
Salvo cambiamenti tecnici

Technische wijzigingen voorbehouden  
Forbehold om tekniske endringer  
Nos reservamos el derecho de efectuar  
modificaciones técnicas  
Sujeito a alterações técnicas



# HANSA



## Pflegeanleitung für Hansa-Armaturen

Sehr geehrter Kunde,  
mit dieser Hansa-Armatur haben Sie ein Qualitäts-Produkt erworben. Um die Schönheit der hochwertigen Oberfläche zu erhalten, sind folgende Hinweise zu beachten:

**Chrom, chrom-edelmatt und farbbeschichtete Oberflächen** sind empfindlich gegen säure- und sandhaltige Reinigungsmittel sowie kratzende Schwämme.

### Achtung!

Farbige Oberflächen erfordern eine besonders sorgfältige Behandlung bei Einbau und Benutzung. Farbabweichungen bei farbbeschichteten Oberflächen sind verfahrensbedingt.

### Pflege:

Bei Verschmutzung oder Verkalkung, Armaturen mit Seifenwasser oder verdünntem Haushaltsessig reinigen, mit klarem Wasser nachspülen und trockenreiben.

Farbige Oberflächen nicht mit alkoholhaltigen- oder Desinfektions-mitteln behandeln. Pflege wie oben.

Schäden, die durch unsachgemäße Behandlung entstehen, unterliegen nicht der Hansa-Gewährleistung.



## Care and maintenance instructions for Hansa faucets

Dear Customer,  
you have purchased a high quality product, and to maintain its beautiful appearance for a long time to come, we suggest that you care for it as follows:

**Chrome, velvet chrome and colour coated surfaces** are sensitive to cleaning agents containing acids or abrasives as well as abrasive sponges.

### Important!

Colour coated surfaces require extra care during installation and use. Slight colour variations can occur with colour coated faucets as a result of unavoidable process variations.

### Maintenance:

Dirty and surface calcination are best removed with soapy water, followed by rinsing with plain water and drying.

Avoid exposure of colour coated surfaces to disinfectants or cleaning agents containing alcohol, and treat such surfaces as described above.

Careless treatment of faucets invalidates Hansa guarantee provisions.



## Conseils d'entretien de notre robinetterie

Cher client,

avec cette robinetterie, vous avez acquis un produit de qualité, et afin de préserver la beauté de la surface, veuillez bien suivre nos conseils.

### Surfaces chromée, chromée-mat et traitements de couleur:

Eviter les acides et les produits contenant du sable, ainsi que les éponges rugueuses.

### Attention!

Les traitements en couleur demandent une manipulation très soignée au montage et lors de l'utilisation.

Une légère différence de nuance est possible lors du traitement.

### Entretien:

En cas de salissure ou de dépôt de calcaire, nettoyer avec de l'eau savonneuse. Rincer avec de l'eau tiède et essuyer. Les pièces traitées ne doivent pas être nettoyées avec des produits contenant de l'alcool, ou des produits désinfectants. Entretien comme décrit ci-dessus.

Les dommages dus à une utilisation non conforme à ces conseils ne sont pas couverts par la garantie.



## Rubinetteria Hansa Manutenzione delle superfici

Egregio Cliente,

Lei ha acquistato un rubinetto Hansa di alta qualità. Per mantenere inalterata nel tempo la bellezza della superficie dovrà osservare alcune norme:

### superfici cremate lucide, cremate opache e colorate

sono sensibili ai detersivi acidi e granulosi, nonché alle spugne ruvide.

### Attenzione!

Le superfici colorate devono essere trattate con particolare cura nel montaggio e nell'uso. Variazioni di tonalità nelle superfici colorate sono dovute alle tecniche di lavorazione.

### Manutenzione:

Per togliere sporcizia o calcare, pulire i rubinetti con acqua e sapone, sciacquare con acqua pulita ed asciugare con un panno asciutto.

Non trattare le superfici colorate con detersivi a base di alcool o disinfettanti. Usare la medesima cura come sopra. Le Hansa non assume alcuna garanzia per danni conseguenti a trattamenti impropri.



## Onderhoudsvorschriften voor Hansa-kranen

Beste klant,

Met deze Hansa-kranen heeft u een kwaliteitsproduct aangeschaft. Om de schoonheid van het hoogwaardige oppervlak te behouden, moet men de volgende voorschriften inachtnemen.

**Verchroomde, chrom-edelmatt en kleurbedeelde oppervlakken**, zijn niet bestand tegen bijtende en schurende reinigingsmiddelen, alsook niet tegen krassende poetsdoeken.

### Opgelet!

Kleuroppervlakken vereisen een zorgvuldige behandeling bij montage en gebruik. Kleurafwijking bij kleurbedeelde oppervlakken zijn steeds mogelijk.

### Onderhoud:

Bij vervulling of kalkafzetting, de kraan met zachte zeep of zeepoplossing reinigen, met zuiver water afspoelen en droogwrijven.

Gekleurde oppervlakken niet met alcoholhoudende of desinfecterende middelen behandelen. Behandeling als boven aangegeven.

Beschadigingen ontstaan door een niet aangepaste behandeling vallen buiten de garantie van Hansa.



## Vedlikehold av Hansa-armatur

Med denne Hansa-armatur har de fått et kvalitetsprodukt. For å beholde skjønnheten av den høyverdige overflaten, må det tas hensyn til følgende:

### Krom, krom-edelmatt

nhdellige rengjøringsmidler såvel som svamper som riper.

### OBS!

Fargebelagte overflater fordrer en særlig forsiktig behandling ved montering og benyttelse.

Fargeavvikelser ved fargebelagte overflater er betinget av metoden.

### Vedlikehold:

Ved urenheter eller forkalkning rengjør armaturen med såpevann spyll etterpå med rent vann og-tork med bløt klut.

Farvede overflater må ikke behandles med alkoholholdige midler eller desinfeksjonsmidler. Still som ovenfor.

Skader, som oppstår ved usaklig behandling, kommer ikke inn under Hansagarantien.



## Consejos para el mantenimiento de nuestra grifería

Con esta grifería, Ud. ha adquirido un producto de calidad.

Para conservar impecable su superficie, deberá seguir nuestras instrucciones:

### Superficies cromada, cromada-mate y tratamiento de color:

Evitar los ácidos y los productos que contienen arena, así como las esponjas ásperas.

### ¡Atención!

Los tratamientos en color requieren una manipulación muy cuidadosa en el montaje y en su empleo.

### Limpeza:

En caso de suciedad o sedimento calcáreo, lavar con agua jabonosa. Enjuagar con agua tibia y secar. Las piezas en color no deben limpiarse con productos que contengan alcohol o acetona, ni con productos desinfectantes.

Los daños o averías debidos a una utilización no conforme con estas instrucciones no están cubiertos por la garantía.



## Conselhos para a conservação da nossa gama de torneiras

Com esta gama de torneiras, você adquiriu um produto de qualidade. Para conservar a sua superfície impecável, deverá seguir as nossas instruções:

### Superfície cromada, cromada-mate e tratamento de cor:

Evitar os ácidos e os produtos que contenham areia, assim como, as esponjas ásperas.

### Atenção!

Os tratamentos em cor requerem uma manipulação muito cuidadosa na montagem e no seu emprego.

### Limpeza:

Em caso de sujidade e sedimento calcário, lavar com água com sabão. Enxaguar com água tépida e secar. As peças em cor não devem limpar-se com produtos que contenham álcool ou acetona, nem com produtos desinfectantes.

Os danos ou avarias devidos a uma utilização que não se coadune com estas instruções, não estão cobertos pela garantia.

