

# Installation Instructions / Warranty

**hansgrohe**



**Accessories**

**interaktiv**

**hansgrohe**

**retroaktiv**

**hansgrohe**

## Interaktiv / Retroaktiv Accessories

Accessory	Interaktiv	Retroaktiv
Tumbler w/holder	06589XX0	06090XX0
Soap dish w/holder	06592XX0	06091XX0
Soap dispenser	06593XX0	06092XX0
Toilet paper holder	06596XX0	06093XX0
Toilet brush	06600XX0	06094XX0
Towel ring	06596XX0	06095XX0
Hook	06594XX0	06096XX0
Robe hook	06595XX0	06099XX0
12" Towel bar	06598XX0	06097XX0
24" Towel bar	06866XX0	06098XX0

## Interaktiv Accessories

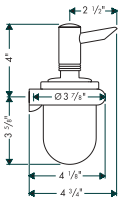

Soap  
Dispenser  
06593XX0

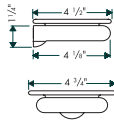

Soap Dish  
06592XX0

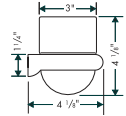

Tumbler  
06589XX0

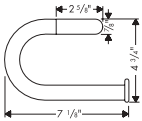

Towel Hook / Toilet  
Paper Holder  
06596XX0



Face Cloth Hook  
06594XX0

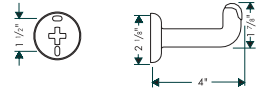

Robe Hook  
06595XX0

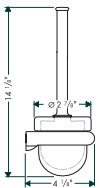

Toilet Brush  
06600XX0

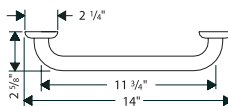

12" Towel Bar  
06598XX0

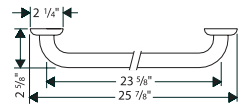

24" Towel Bar  
06866XX0

# Retroaktiv Accessories

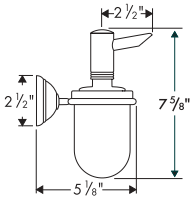

06092XX0  
Soap Dispenser

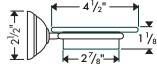

06091XX0  
Soap Dish

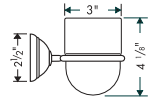

06090XX0  
Tumbler

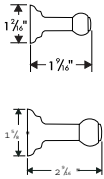

06096XX0  
Face Cloth Hook  
06099XX0  
Robe Hook

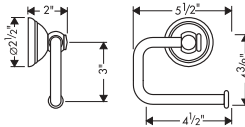

06093XX0  
Toilet Paper Holder

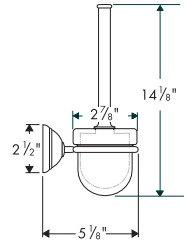

06094XX0  
Toilet Brush

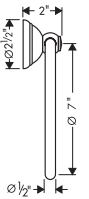

06095XX0  
Towel Ring

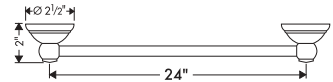
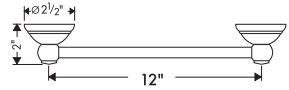

06097XX0  
12" Towel Bar  
06098XX0  
24" Towel Bar

## Interaktiv Accessories

Installation Instructions: 06593XX0 soap dispenser, 06589XX0 tumbler, 06592XX0 soap dish, 06600XX0 toilet brush

- Mark the positions of the screw holes on the wall. Make sure that they are level.
- Drill the screw holes using a 6 mm drill bit suitable for the wall surface.
- Install the anchors. Seal around the anchors with a good quality waterproof bathroom sealant.
- Screw the holder mounting bracket into the anchors. The detent pin on the mounting bracket should be on the bottom.
- Slide the holder cover over the mounting bracket so that the detent pin on the mounting bracket clicks into place in the corresponding hole in the cover.
- Place the accessory (soap dish/soap dispenser/tumbler/toilet brush cup) into the holder.
- The accessory may be removed from the holder for cleaning.

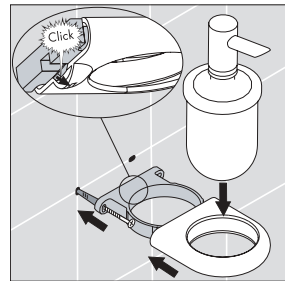
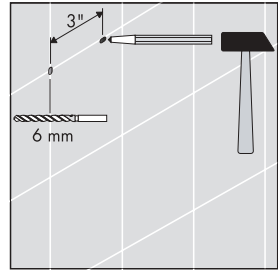

## Refilling the soap dispenser

Lift the pump assembly off the bottle. Refill the bottle. Replace the pump assembly.

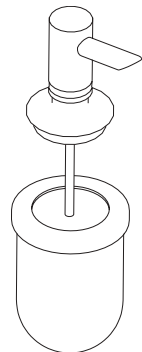

## Installation Instructions: O6596XXO Towel Ring / Toilet Paper Holder

- Mark the positions of the screw holes.
- Drill the screw holes using a 6 mm bit suitable for the wall surface.

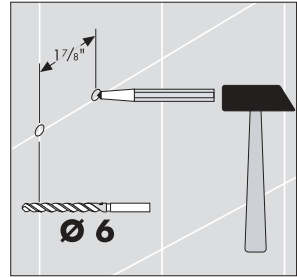

- Install the anchors. Seal around the anchors using waterproof bathroom sealant.
- Screw the mounting bracket into the anchors.
- Slide the toilet paper holder over the mounting bracket.

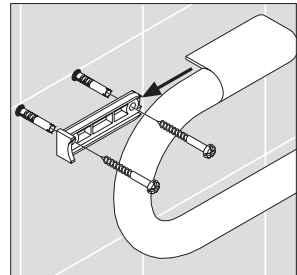

Installation Instructions: 06594XX0 Face Cloth Hook, 06595XX0 Robe Hook

- Mark the positions of the screw holes on the wall.
- Drill the screw holes with a 6 mm drill bit suitable for the wall surface.

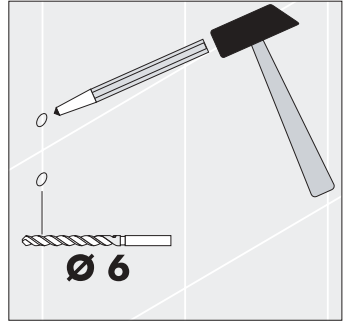

- Install the anchors. Seal the wall around the anchors with a waterproof bathroom sealant.
- Screw the hook into the wall.
- Slide the screw cover against the wall.

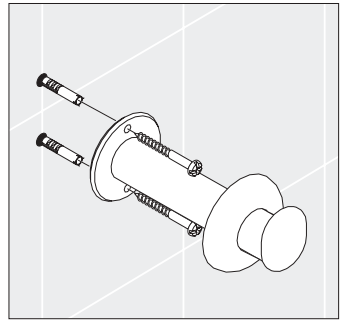

## Warning:

**This towel bar is not a grab bar. Attempting to use it as a grab bar may result in injury to the user and/or damage to the wall.**

- Mark the positions of the screw holes. Make sure that they are level.
- Drill the holes using a 6 mm drill bit suitable for the wall surface.

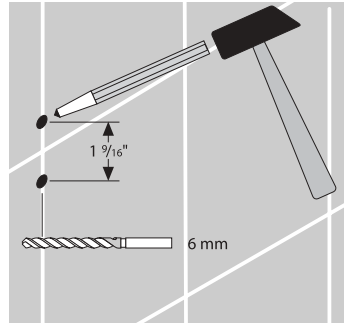

- Install the anchors. Seal around the anchors using silicone bathroom sealant.
- Screw the towel bar into the anchors. Slide the escutcheon over the screws.

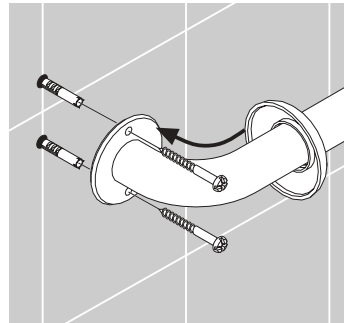

## Retroaktiv Accessories

Installation Instructions: 06092XX0 Soap Dispenser, 06091XX0 Soap Dish, 06090XX0 Tumbler, 06093XX0 Toilet Paper Holder, 06094XX0 Toilet Brush, 06095XX0 Towel Ring, 06097XX0 / 06098XX0 Towel Bars

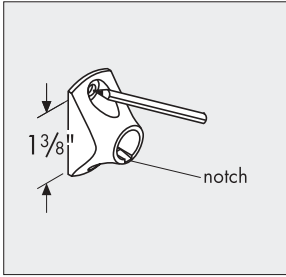

- Using the mounting piece as a template, mark the positions of the screw holes.

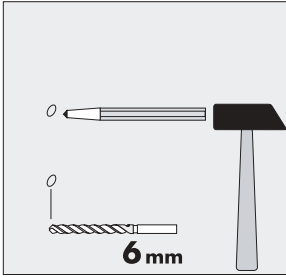

- Dimple the tile. Drill the holes with a 6mm bit suitable for the wall surface.

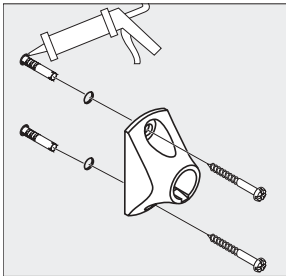

- Install the anchors. Seal the wall around the anchors with a compatible, non-staining, waterproof bathroom sealant. Screw the mounting piece to the wall, with the notch on the bottom.

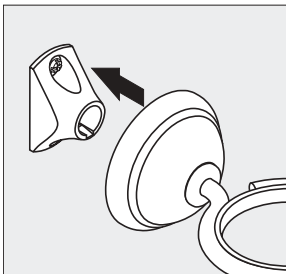

- Press the accessory firmly over the mounting piece.

**IMPORTANT:** Do not "experiment". Do not press the mounting piece into the accessory unless the mounting piece is screwed firmly to the wall.



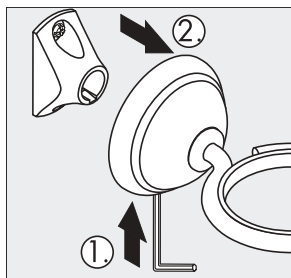

### To remove the accessory from the wall

Press a small tool, such as an allen wrench, through the hole in the bottom of the escutcheon, against the retaining pin. At the same time, pull out on the holder.

### Installation Instructions: 06096XX0 Face Cloth Hook, 06099XX0 Robe Hook

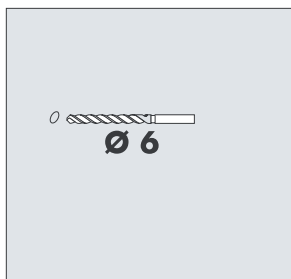

- Drill the hole using a 6 mm bit suitable for the wall surface.

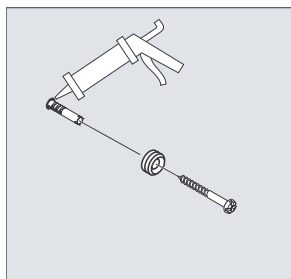

- Install the anchor. Seal the wall around the anchor with a suitable, waterproof bathroom sealant.
- Screw the mounting piece to the wall.

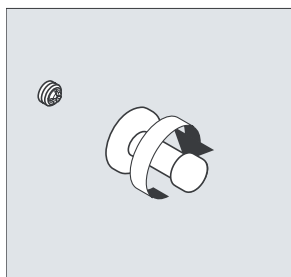

- Screw the hook to the mounting piece

## **Cleaning Recommendation for Hansgrohe Products**

Modern faucetry and shower products utilize a combination of materials to comply with the needs of the market with regard to design and functionality.

To avoid damage, it is necessary to use some caution when cleaning. Damage caused by improper treatment is not covered under the Hansgrohe warranty.

### **Cleaning Materials for Faucets and Showers**

- To remove lime scale, use only products made specifically for that purpose. Always follow the manufacturer's instructions when using.
- Do not use cleaners that contain hydrochloric, formic, acetic, or phosphoric acids, as these will cause considerable damage to finishes and to plastic components.
- Never mix cleaning materials.
- Never use cleaners containing abrasives. Do not use abrasive cleaning cloths, pads, or sponges.

### **Cleaning Procedures**

- Clean your faucets and shower products as and when required. Regular cleaning will prevent scale buildup and water spotting.
- Follow the label instructions. Do not allow any cleaner to remain on the product for longer than necessary.
- When using spray cleaners, spray first onto a sponge or cloth – do not spray directly onto the product.
- After cleaning, rinse thoroughly with clear water to remove any cleaner residue.

### **Important**

- Soap and shampoo residue can also cause damage to the product. Rinse well with clean water after use.
- If the surface is already damaged, harsh cleaning materials will cause further damage.

## Limited Lifetime Consumer Warranty

This product has been manufactured and tested to the highest quality standards by Hansgrohe, Inc. ("Hansgrohe"). This warranty is limited to Hansgrohe products which are purchased by a consumer in the United States after March 1, 1996, and installed in either the United States or Canada.

### WHO IS COVERED BY THE WARRANTY

This warranty extends to the original consumer purchaser only.

### WHAT IS COVERED BY THE WARRANTY

This warranty covers only your Hansgrohe manufactured product. Hansgrohe warrants this product against defects in material or workmanship as follows: Hansgrohe will repair at no charge for parts only or, at its option, replace any product or part of the product which proves defective because of improper workmanship and/or material, under normal installation, use, service and maintenance. If Hansgrohe is unable to provide a replacement and repair is not practical or cannot be timely made, Hansgrohe may elect to refund the purchase price in exchange for the return of the product.

### LENGTH OF WARRANTY

Replacement or repaired parts of products will be covered for the term of this warranty as stated in the following two sentences. If you are a consumer who purchased the product for use primarily for personal, family, or household purposes, this warranty extends for as long as you own the product and the home in which the product is installed. If you purchased the product for use primarily for any other purpose, including, without limitation, a commercial purpose, this warranty extends only (i) for 1 year, with respect to Interaktiv and Retroaktiv products, and (ii) for 5 years, with respect to AXOR, ShowerPower and Pharo products.

### THIS WARRANTY DOES NOT COVER, AND HANSGROHE WILL NOT PAY FOR:

- A. Conditions, malfunctions or damage not resulting from defects in material or workmanship.
- B. Conditions, malfunctions or damage resulting from (1) improper installation, improper maintenance, misuse, abuse, negligence, accident or alteration, or (2) the use of abrasive or caustic cleaning agents or "no rinse" cleaning products, or the use of the product in any manner contrary to the product instructions.
- C. Labor or other expenses for the disconnection or return of the product for warranty service, or for installation or reinstallation of the product.
- D. Accessories or related products not manufactured by Hansgrohe.

### TO OBTAIN WARRANTY SERVICE

Contact your Hansgrohe retailer, or write to Technical Service at:

Hansgrohe Inc.  
1492 Bluegrass Lakes Parkway  
Alpharetta GA 30004

Or, call Hansgrohe toll-free at (800) 334-0455.

In requesting warranty service, you will need to provide

- 1. The sales receipt or other evidence of the date and place of purchase.
- 2. A description of the problem.
- 3. Delivery of the product or the defective part, postage prepaid and carefully packed and insured, to Hansgrohe Inc. 1492 Bluegrass Lakes Parkway, Alpharetta, Georgia 30004, Attention: Technical Service, if required by Hansgrohe.

When warranty service is completed, any repaired or replacement product or part will be returned to you postage prepaid.

## **EXCLUSIONS AND LIMITATIONS**

**REPAIR OR REPLACEMENT (OR, IN LIMITED CIRCUMSTANCES, REFUND OF THE PURCHASE PRICE) AS PROVIDED UNDER THIS WARRANTY IS THE EXCLUSIVE REMEDY OF THE PURCHASER. HANS GROHE NEITHER ASSUMES NOR AUTHORIZES ANY PERSON TO CREATE FOR IT ANY OBLIGATION OR LIABILITY IN CONNECTION WITH THIS PRODUCT.**

**HANS GROHE SHALL NOT BE LIABLE TO PURCHASER OR ANY PERSON FOR ANY INCIDENTAL, SPECIAL, OR CONSEQUENTIAL DAMAGES, ARISING OUT OF BREACH OF THIS WARRANTY OR ANY IMPLIED WARRANTY (INCLUDING MERCHANTABILITY).**

Some States do not allow the exclusion or limitation of incidental or consequential damages, so the above limitation or exclusion may not apply to you.

This warranty gives you specific legal rights, and you may have other rights which vary from State to State.

You may be required by law to give us a reasonable opportunity to correct or cure any failure to comply before you can bring any action in court against us under the Magnuson-Moss Warranty Act.

## **PRODUCT INSTRUCTIONS AND QUESTIONS**

Upon purchase or prior to installation, please carefully inspect your Hansgrohe product for any damage or visible defect. Prior to installing, always carefully study the enclosed instructions on the proper installation and the care and maintenance of the product. If you have questions at any time about the use, installation, or performance of your Hansgrohe product, or this warranty, please call or write to us at the toll-free number and address printed above.