



Buy it for looks. Buy it for life.®

Specifications

DESCRIPTION

- Metal construction
- Installs on 10"(254mm) centers
- Designed to be installed on finished decks up to 3-3/8" (86mm)
- Integral 1/2" Pex connections
- Includes (2) 1/2" CPVC adapters
- 140715 kit available separately to connect to 1/2" cold expansion Pex
- Includes brass test plug

OPERATION

- Can be installed with any Moen deck mounted roman tub trim kit
- Rotate hot side handle counterclockwise to open (clockwise to close) and the cold side handle clockwise to open (counterclockwise to close)

FLOW

- Designed to deliver 14 gpm at 45 psi. (53L/min)

CARTRIDGE

- Nonmetallic and stainless steel materials

STANDARDS

- Designed and manufactured to comply with the applicable requirements of: ASME A112.18.1/CSA B-125.1, ASTM F1807, CSA B137.5 for PEX, ASTM D2846, CSA B137.6 for CPVC and all applicable requirements referenced therein
- 1/2" PEX fittings compatible with PEX tubing manufactured to ASTM F877
- 1/2" CPVC fittings manufactured to ASTM D2846

WARRANTY

- Lifetime limited warranty against leaks, drips and finish defects to the original consumer purchaser
- 5 year warranty if used in commercial installations

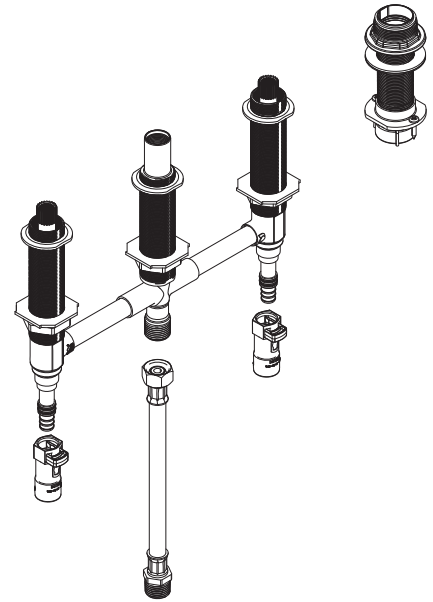

Roman Tub High Flow Rough-In Valve

(104465 Thermostatic Mixing Valve Sold Separately)

Model: 9797

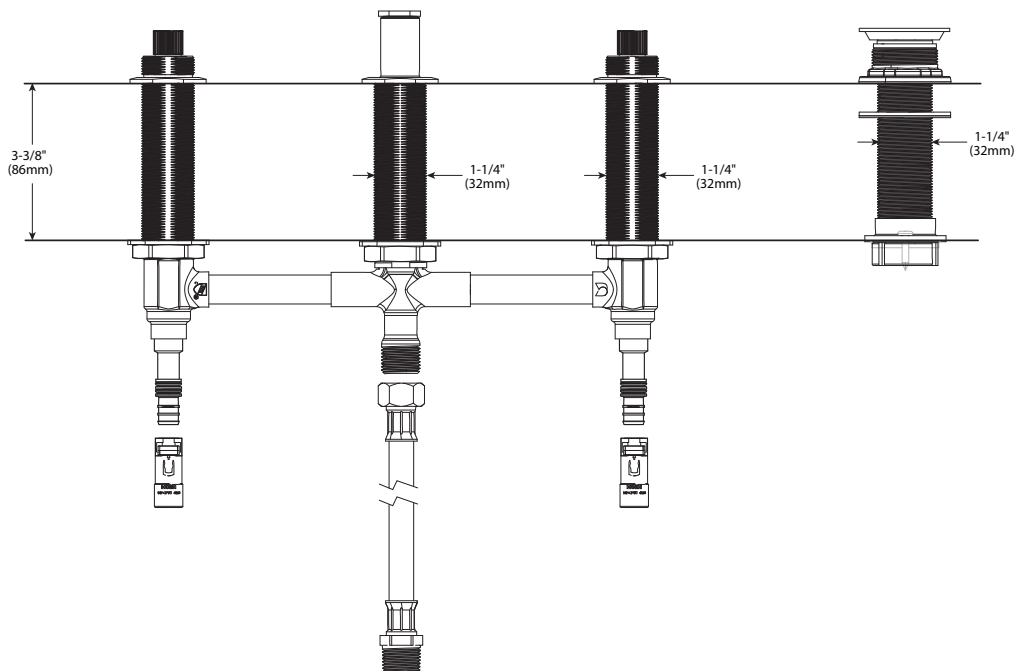

CRITICAL DIMENSIONS

(DO NOT SCALE)