

**WALL-MOUNT FAUCET
K-T154**

ADA

Features

- Dual control wall-mounted
- Brass construction
- 2.2 gallons (8.3 L) per minute [max at 60 psi (4.14 bar)]
- Cross handles

Codes/Standards Applicable

Specified model meets or exceeds the following:

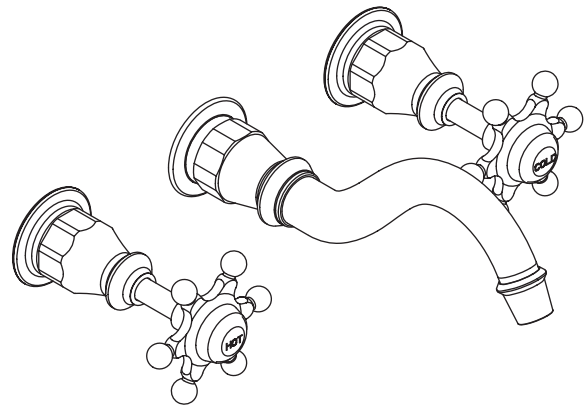

- ASME A112.18.1
- CSA B125
- IAPMO/UPC
- NSF 61
- Energy Policy Act of 1992 (EPACT)
- ADA



Colors/Finishes

- CP: Polished Chrome
- Other: Refer to Price Book for additional colors/finishes

Specified Model





Model	Description	 ADA
K-T154-3	Antique Six Prong Handles With a 8.5" (21.6 cm) Spout	<input type="checkbox"/> CP <input type="checkbox"/> Other ____
Required Accessory		
K-410-K	Wall-Mount Valve	<input type="checkbox"/> NA

Optional Accessories on Page 2.

Product Specification

Dual-control wall-mount faucet shall be of brass construction. Product shall include cross handle. Trim shall be Kohler Model K-T154-3-____.

ANTIQUETM

Optional Accessories					
K-7702	Pop-Up Lavatory Drain	<input type="checkbox"/> CP			
K-7710	Lavatory Drain		<input type="checkbox"/> CP		
K-7715	Lavatory Drain			<input type="checkbox"/> CP	
K-8801	Duostrainer Sink Strainer				<input type="checkbox"/> CP <input type="checkbox"/> Other_____

Installation Notes

Install this product according to the installation guide.

1-1/2" (3.8 cm) to 6" (15.2 cm) minimum must be maintained between bottom of spout and top of the fixture rim.

Three 1-1/2" D. (3.8 cm) cut-out holes required for spout and handle.

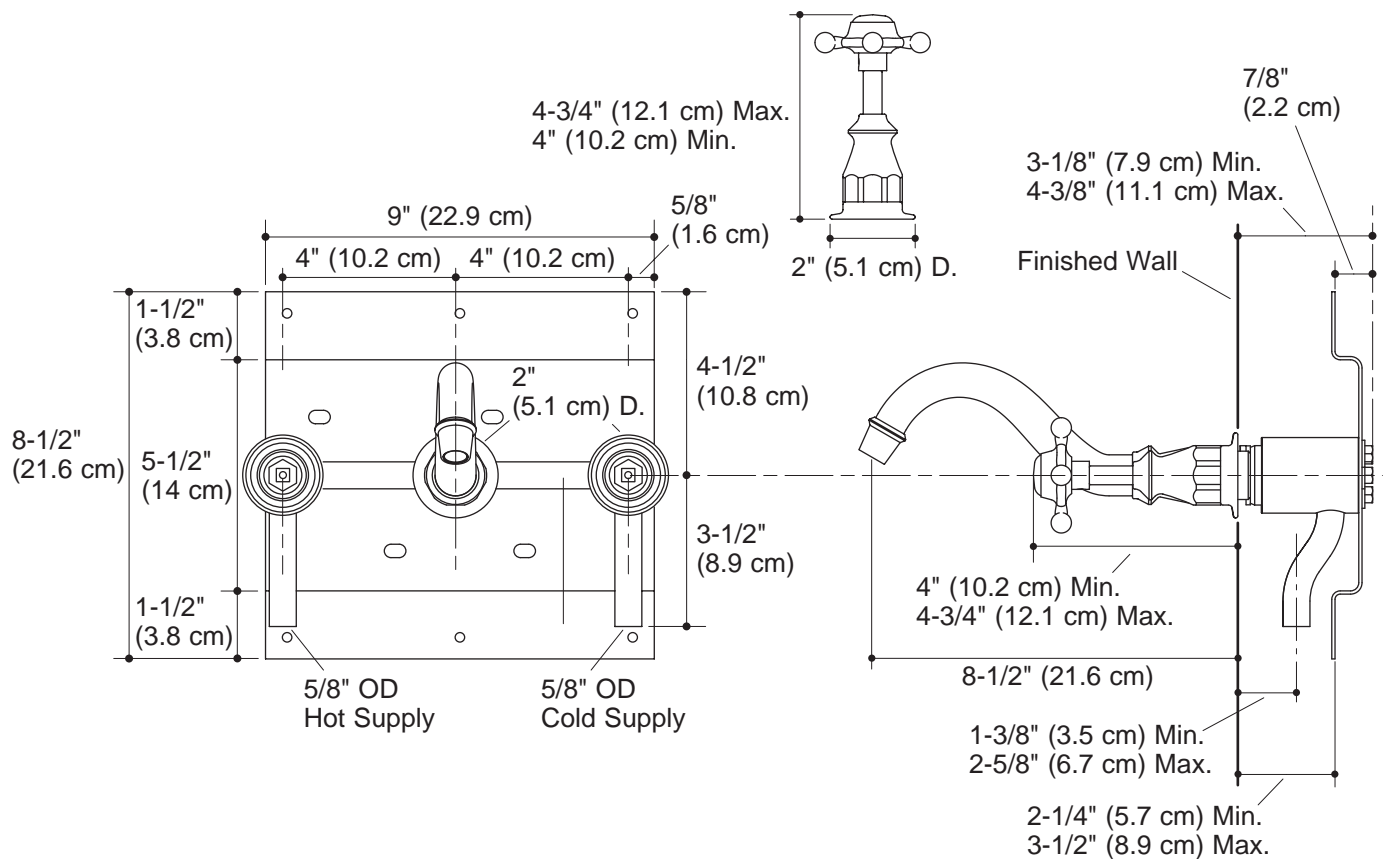

Product Diagram