

Features





- Brass construction
- Contemporary, minimal design
- Complements Stillness® faucet line

ACCESSORIES K-14450

Colors/Finishes

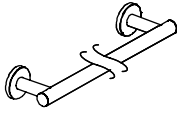
- CP: Polished Chrome
- Other: Refer to Price Book for additional colors/finishes

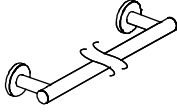
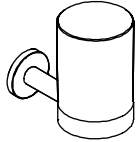
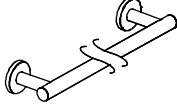
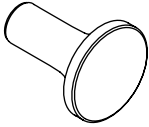
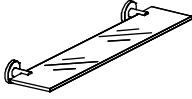
Specified Model

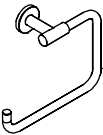
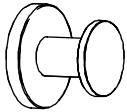
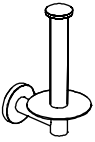
Model/Description		Model/Description	
K-14450 18" (45.7 cm) towel bar <input type="checkbox"/> CP <input type="checkbox"/> Other_____		K-14461 Soap dish <input type="checkbox"/> CP <input type="checkbox"/> Other_____	
K-14451 24" (61 cm) towel bar <input type="checkbox"/> CP <input type="checkbox"/> Other_____		K-14463 Tumbler/toothbrush holder <input type="checkbox"/> CP <input type="checkbox"/> Other_____	
K-14452 30" (76.2 cm) towel bar <input type="checkbox"/> CP <input type="checkbox"/> Other_____		K-11484 Knob cabinet hardware <input type="checkbox"/> CP <input type="checkbox"/> Other_____	
K-14455 Glass shelf <input type="checkbox"/> CP <input type="checkbox"/> Other_____		K-14386 Pull cabinet hardware <input type="checkbox"/> CP <input type="checkbox"/> Other_____	
K-14456 Towel ring <input type="checkbox"/> CP <input type="checkbox"/> Other_____			
K-14458 Robe hook <input type="checkbox"/> CP <input type="checkbox"/> Other_____			
K-14459 Toilet tissue holder <input type="checkbox"/> CP <input type="checkbox"/> Other_____			

STILLNESS®

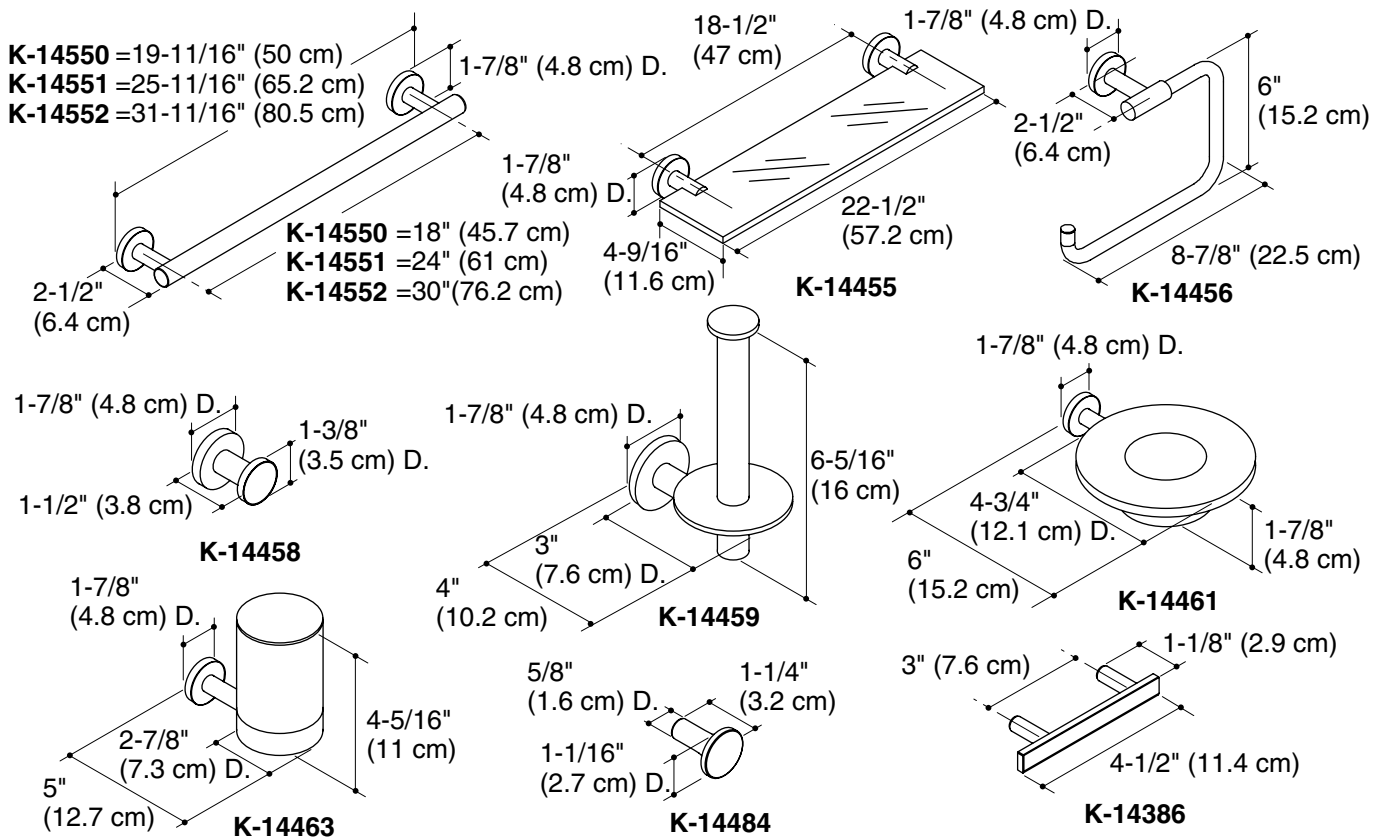

Product Diagram