





**Features**

- Brass construction
- Traditional styling
- Complements Revival® faucet line

**Colors/Finishes**

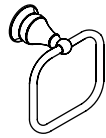
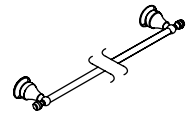
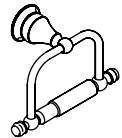
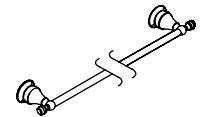
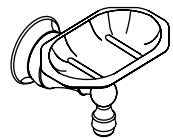
- CP: Polished Chrome
- PB: Vibrant® Polished Brass
- Other: Refer to Price Book for additional colors/finishes

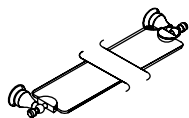
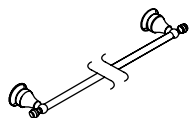
**Specified Model**

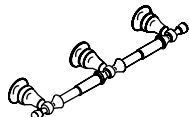
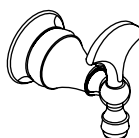
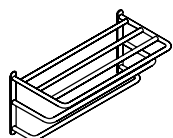
Model/Description		Model/Description	
K-16140 Towel ring <input type="checkbox"/> CP <input type="checkbox"/> PB <input type="checkbox"/> Other_____		K-16147 30" (76.2 cm) towel bar <input type="checkbox"/> CP <input type="checkbox"/> PB <input type="checkbox"/> Other_____	
K-16141 Toilet tissue holder <input type="checkbox"/> CP <input type="checkbox"/> PB <input type="checkbox"/> Other_____		K-16148 18" (45.7 cm) towel bar <input type="checkbox"/> CP <input type="checkbox"/> PB <input type="checkbox"/> Other_____	
K-16142 Soap dish <input type="checkbox"/> CP <input type="checkbox"/> PB <input type="checkbox"/> Other_____		K-16149 Tumbler and toothbrush holder, includes glass tumbler <input type="checkbox"/> CP <input type="checkbox"/> PB <input type="checkbox"/> Other_____	
K-16143 Glass shelf <input type="checkbox"/> CP <input type="checkbox"/> PB <input type="checkbox"/> Other_____		K-16150 24" (61 cm) towel bar <input type="checkbox"/> CP <input type="checkbox"/> PB <input type="checkbox"/> Other_____	
K-16145 Oval mirror, includes pivot mounting brackets <input type="checkbox"/> CP <input type="checkbox"/> PB <input type="checkbox"/> Other_____		K-16152 Revival 14" (35.6 cm) double toilet tissue holder <input type="checkbox"/> CP <input type="checkbox"/> PB <input type="checkbox"/> Other_____	
K-16146 Robe hook <input type="checkbox"/> CP <input type="checkbox"/> PB <input type="checkbox"/> Other_____		K-16155 Towel shelf <input type="checkbox"/> CP <input type="checkbox"/> PB	



**Product Specification**

The accessories shall be made of brass construction. Accessories shall have traditional styling. Accessories shall complement Revival faucet line. Accessories shall be Kohler Model K-\_\_\_\_-\_\_\_\_.

# REVIVAL®

## Installation Notes

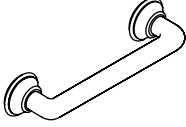
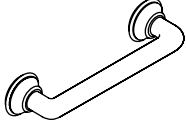
Install this product according to the installation guide.

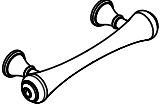
Model/Description	
K-16156 12" (30.5 cm) grab bar <input type="checkbox"/> CP <input type="checkbox"/> PB <input type="checkbox"/> Other_____	
K-16158 18" (45.7 cm) grab bar <input type="checkbox"/> CP <input type="checkbox"/> PB	
K-16295 Knob cabinet hardware <input type="checkbox"/> CP <input type="checkbox"/> PB <input type="checkbox"/> Other_____	
K-16296 Pull cabinet hardware <input type="checkbox"/> CP <input type="checkbox"/> PB <input type="checkbox"/> Other_____	

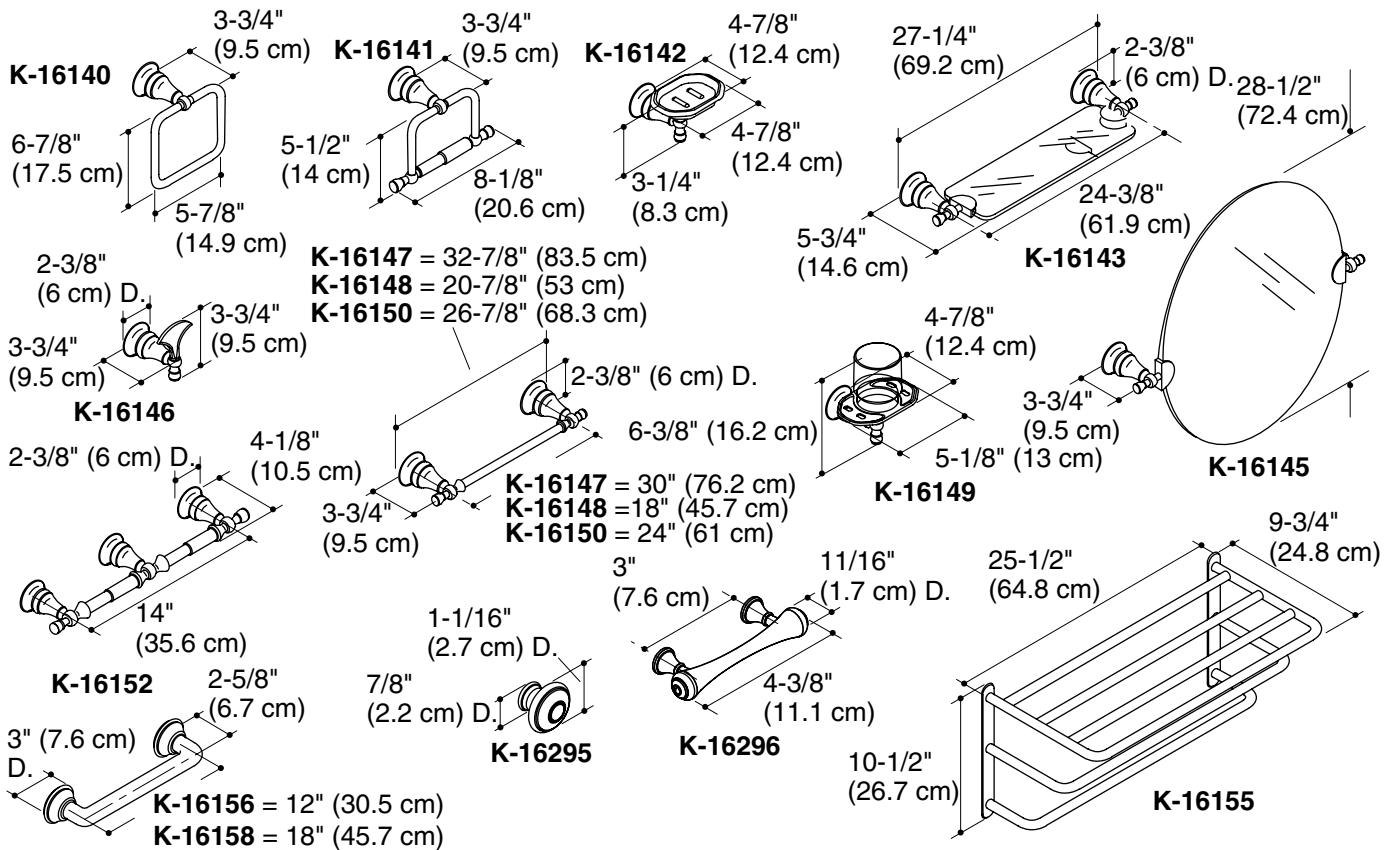

## Product Diagram