

FEATURES

- Brass construction
- Variety of handle style options
- Intended for use with Rite-Temp or HiFlow Rite-Temp valves

**BATH AND SHOWER FAUCET TRIM
K-T130**

ALSO K-T132, K-T134, K-304, K-306-KS

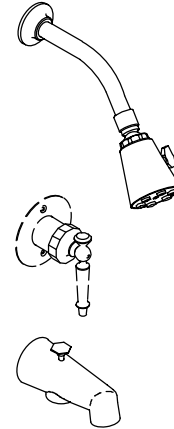

CODES/STANDARDS APPLICABLE

Specified model meets or exceeds the following:

- ASME/ANSI A112.18.1M
- ASSE/ANSI 1016
- CSA B125
- IAPMO/UPC

COLORS/FINISHES

- CP Polished Chrome
- PB Polished Brass
- Other Refer to Faucets Price Book for additional finishes

SPECIFIED MODEL: For complete faucet, both faucet trim and Rite-Temp valve must be specified.

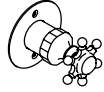
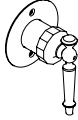
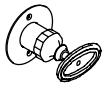



Model	Description		 ADA	
Bath and Shower:				
K-T130-3D	With Six-Prong Handle	<input type="checkbox"/> CP <input type="checkbox"/> PB		
K-T130-4D	With Lever Handle		<input type="checkbox"/> CP <input type="checkbox"/> PB <input type="checkbox"/> Other	
K-T130-9B	With Oval Handle			<input type="checkbox"/> CP <input type="checkbox"/> PB <input type="checkbox"/> Other
Shower Only:				
K-T132-3D	With Six-Prong Handle	<input type="checkbox"/> CP <input type="checkbox"/> PB		
K-T132-4D	With Lever Handle		<input type="checkbox"/> CP <input type="checkbox"/> PB <input type="checkbox"/> Other	
K-T132-9B	With Oval Handle			<input type="checkbox"/> CP <input type="checkbox"/> PB <input type="checkbox"/> Other
Valve Only:				
K-T134-3D	With Six-Prong Handle	<input type="checkbox"/> CP <input type="checkbox"/> PB		
K-T134-4D	With Lever Handle		<input type="checkbox"/> CP <input type="checkbox"/> PB <input type="checkbox"/> Other	

Required and Optional Accessories on Page 2.

PRODUCT SPECIFICATION:

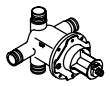
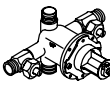
Rite-Temp pressure-balancing single-control bath and shower faucet trim shall be of brass construction. Bath and shower trim shall include showerhead with arm and flange, 4-7/8" diverter spout with N.P.T. connection, and handle. Shower only trim shall include showerhead with arm and flange, and handle. Valve only trim shall include handle. Faucet trim shall be K-T_____-_____-_____ and ceramic dial faceplate shall be Kohler Model K-146-_____. Rite-Temp valve shall be K-304-K_____-NA OR K-306-KS-NA HiFlow Rite-Temp valve.

ANTIQUETM

Required Accessories						
K-304-K	Rite-Temp Valve Without Stops	<input type="checkbox"/> NA				
K-304-KS	Rite-Temp Valve With Stops		<input type="checkbox"/> NA			
K-306-KS	HiFlow Rite-Temp Valve With Integral Stops			<input type="checkbox"/> NA		
K-146	Ceramic Dial Faceplate (For -3D and -4D)				<input type="checkbox"/> Other	
K-262	Ceramic Dial Faceplate and Oval Handle Inset (For-9B)					<input type="checkbox"/> Other

Optional Accessories						
K-9639	Large Lever Insert, Single	<input type="checkbox"/> CP	<input type="checkbox"/> PB			
K-9659	Large Lever Insert, Single	<input type="checkbox"/> Other				
88526	HiFlow Rite-Temp Thin Wall Installation Kit			<input type="checkbox"/> CP	<input type="checkbox"/> PB	<input type="checkbox"/> Other

PRODUCT INFORMATION



WARNING: Risk of damage to the K-306-KS valve assembly. When using the K-306-KS valve in a fiberglass or acrylic installation, use the thin wall installation kit (88526).

INSTALLATION NOTES

Avoid cross-flow conditions. Do not install shut-off device on either valve outlet.

Cap shower outlet if deck-mount spout, diverter, or handshower is connected to spout outlet.

Install straight pipe or tube drop of 7 to 18" with single elbow between valve and wall-mount spout.

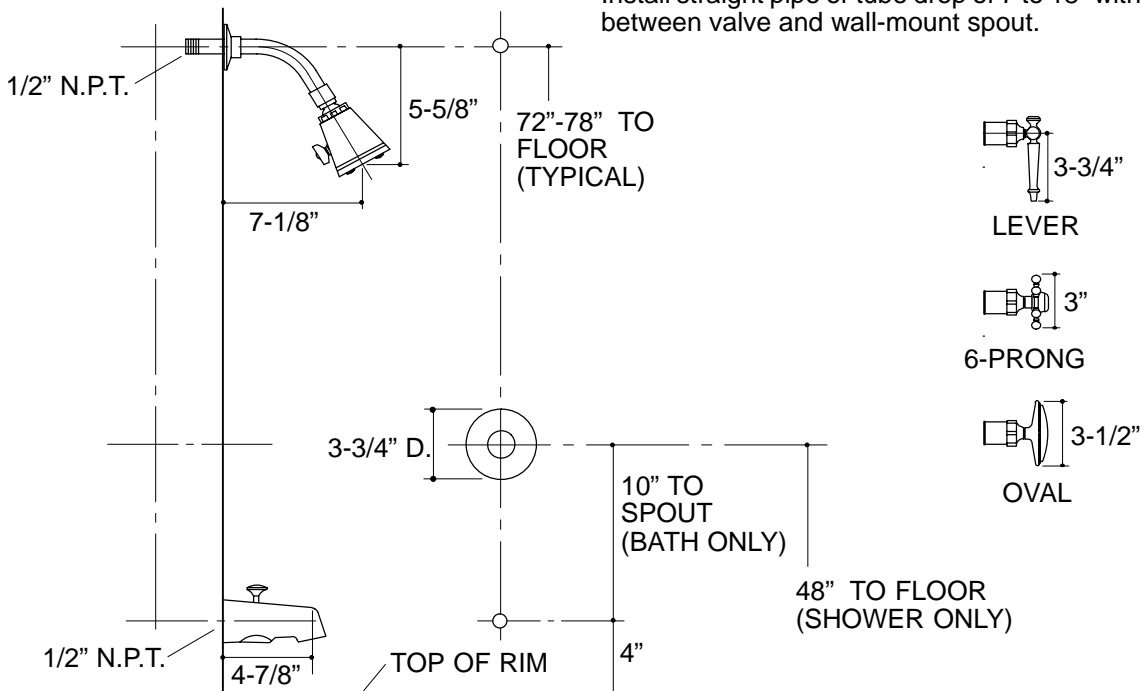

332

PRODUCT DIAGRAM