

### Features

- Neo-angle design makes efficient use of compact space.
- Textured floor pattern.
- Rear drain.
- Coordinates with other products in the Memoirs collection.

### Material

- Acrylic

### Installation

- Single threshold for corner installation.



### Codes/Standards











CSA B45.5/IAPMO Z124  
ASTM E162  
ASTM E662

### KOHLER® One-Year Limited Warranty

See website for detailed warranty information.

### Available Color/Finishes

*Color tiles intended for reference only.*

Color	Code	Description
	0	White
	96	Biscuit
	47	Almond
	NY	Dune
	95	Ice™ Grey
	G9	Sandbar
	33	Mexican Sand™
	K4	Cashmere
	58	Thunder™ Grey
	7	Black Black™

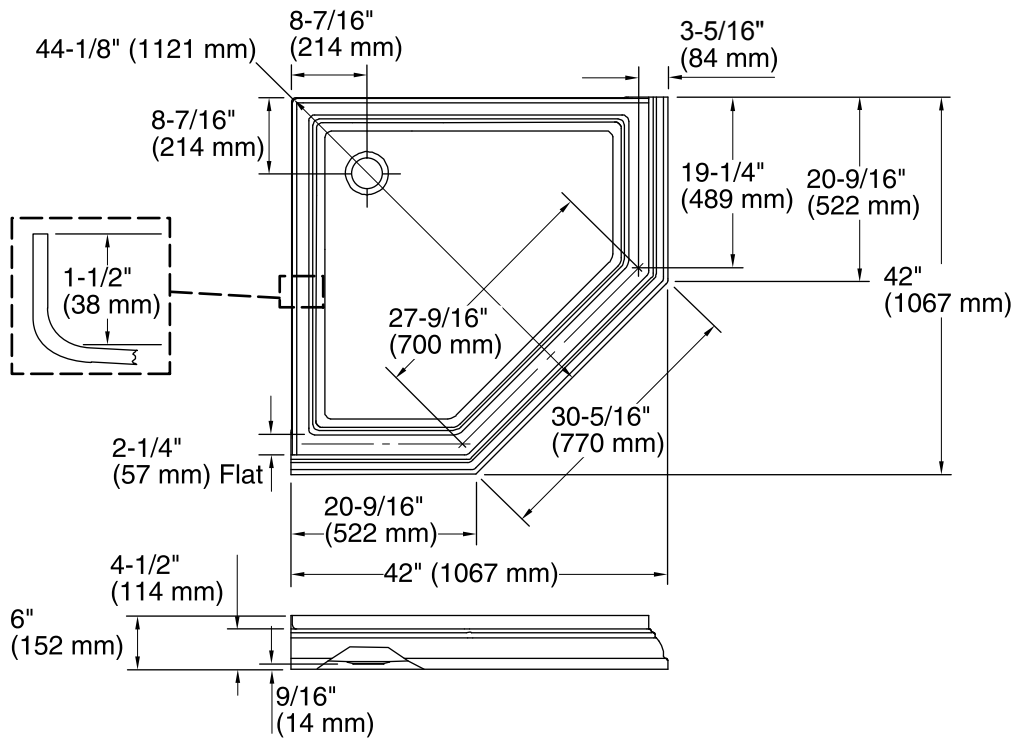

### Technical Information

All product dimensions are nominal.

Installation: Corner  
 Drain location: Center rear  
 Weight: 35 lbs (15.9 kg)

### Notes

Install this product according to the installation guide.