

Features

- Vitreous china.
- One-piece.
- Round bowl.
- Less supply.
- 1.6 gpf (6 lpf).
- Polished chrome trip lever.
- EPDM flapper.
- Rim Jet system.
- Includes French Curve™ seat.
- 12" (305 mm) rough-in.
- 8-1/2" (216 mm) x 8-1/2" (216 mm) water area.
- 25-1/4" (641 mm) x 21-1/8" (537 mm) x 22-3/4" (578 mm).

Optional Accessories

1098662

K-9430 Trip Lever

Components

Product includes:

K-4663 Toilet Seat

Additional included component/s: Tank cover, Trip lever, Bolt cap accessory pack, and Tank accessory pack.



Codes/Standards

ASME A112.19.2/CSA B45.1











DOE - Energy Policy Act 1992

KOHLER® One-Year Limited Warranty

See website for detailed warranty information.

Available Color/Finishes

Color tiles intended for reference only.

Color	Code	Description
	0	White
	96	Biscuit
	47	Almond
	NY	Dune
	95	Ice™ Grey
	G9	Sandbar
	33	Mexican Sand™
	K4	Cashmere
	58	Thunder™ Grey
	7	Black Black™

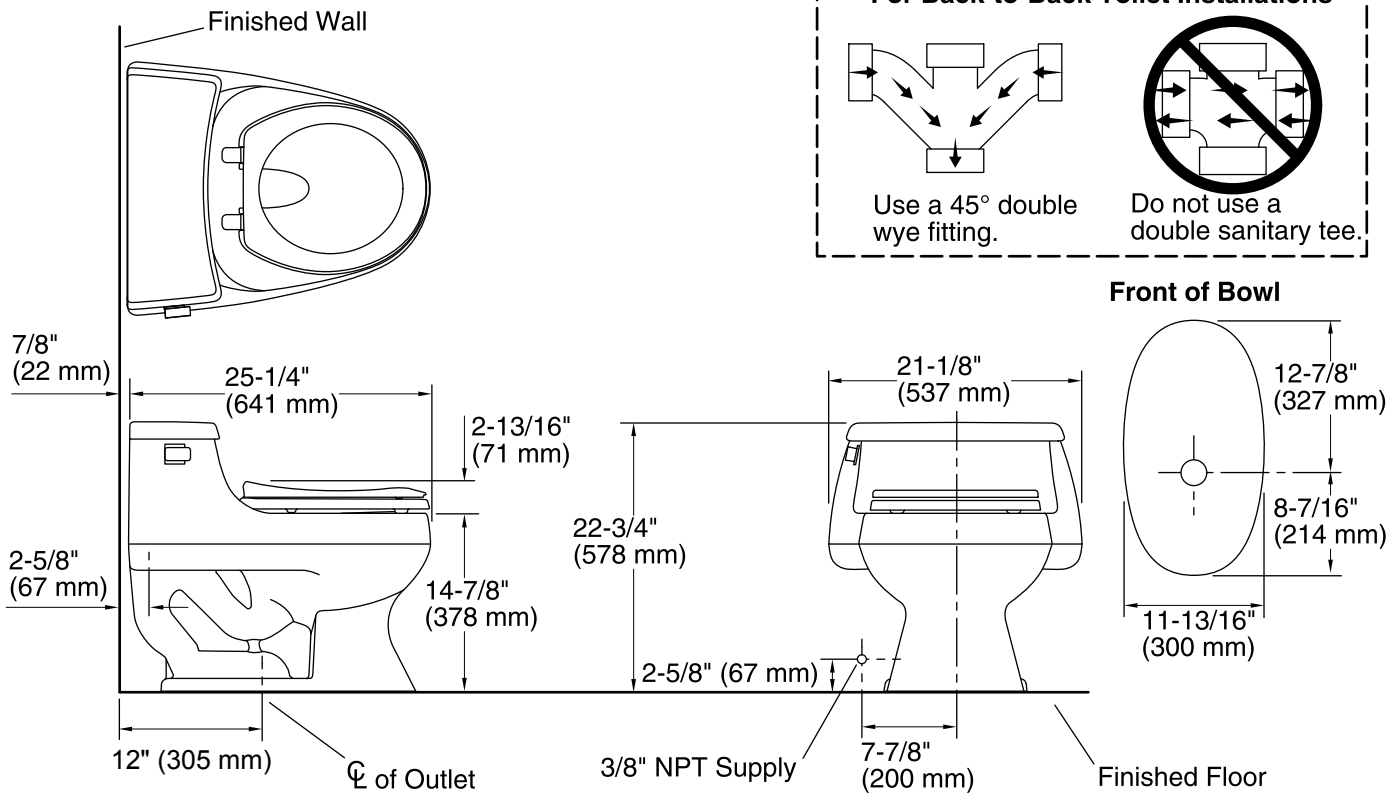

Technical Information

All product dimensions are nominal.

Toilet type:	One-piece
Bowl shape:	Round front
Flush type:	Rim Jet
Trap passageway:	2" (51 mm)
Water Consumption	
Full:	1.6 gpf (6 lpf)
Water surface size:	8-1/2" x 8-1/2" (216 mm x 216 mm)
Rim to water surface:	6-1/16" (154 mm)
Rough-in:	12" (305 mm)
Seat-mounting holes:	5-1/2" (140 mm)

Notes

Install this product according to the installation guide.

For back-to-back toilet installations: Use only a 45° double wye fitting.