

### Features

- Vitreous china.
- Drop-in.
- Rectangular basin.
- With overflow.
- Single faucet hole.
- Coordinates with other products in the Tresham collection.
- 21-13/16" (554 mm) x 16-9/16" (421 mm) x 8-1/16" (205 mm)

### Recommended Accessories

K-8998 P-Trap



ADA

### Codes/Standards











ASME A112.19.2/CSA B45.1  
ADA  
ICC/ANSI A117.1

### KOHLER® One-Year Limited Warranty

See website for detailed warranty information.

### Available Color/Finishes

*Color tiles intended for reference only.*

Color	Code	Description
	0	White
	96	Biscuit
	47	Almond
	NY	Dune
	95	Ice™ Grey
	G9	Sandbar
	33	Mexican Sand™
	K4	Cashmere
	58	Thunder™ Grey
	7	Black Black™

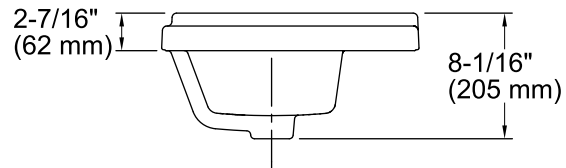
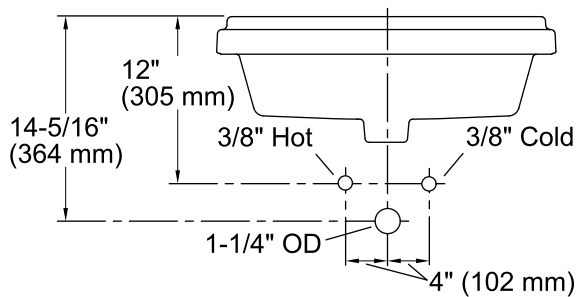
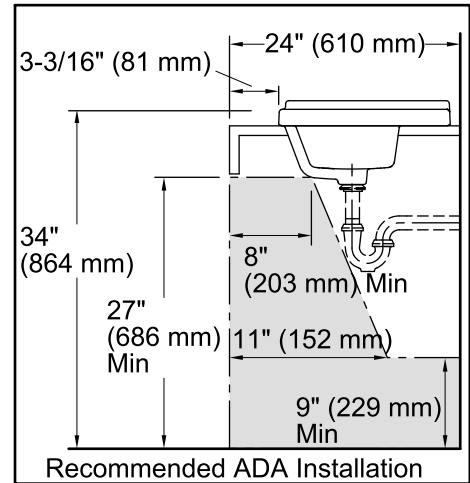
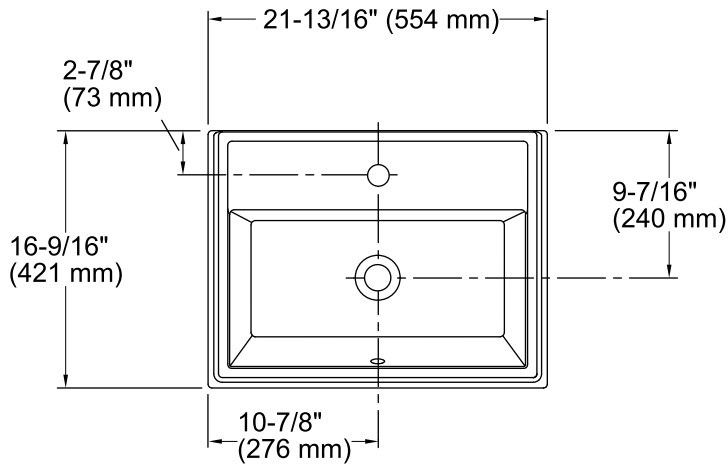

### Technical Information

All product dimensions are nominal.

Bowl configuration:	Single
Installation:	Drop-In
Bowl area (Only)	Length: 19-13/16" (503 mm) Width: 10-3/16" (259 mm) Water depth: 6-1/16" (154 mm)
Number of deck holes:	1
Faucet hole(s):	1-3/8" (35 mm)
Drain hole:	1-3/4" (44 mm)
Template:	Drop-in, 1162721-7, required, included

### Notes

Install this product according to the installation guide.

**NOTICE:** Countertop manufacturer or cutter must use the cut-out template provided with the product, or a current one provided by Kohler Co. (call 1-800-4KOHLER). Kohler Co. is not responsible for cutout errors when the incorrect cut-out template is used.

ADA compliant when installed to the specific requirements of these regulations.