

Features

- Solid polypropylene plastic.
- Elongated closed-front.
- Contoured seat for user comfort.
- Quiet-Close™ lid and ring prevents slamming.
- Quick-Release™ hinge caps snap open and seat pulls forward for removal.
- Quick-Attach™ stainless steel fastener allows for top-mount screwdriver only install.
- Grip-tight bumpers hold seat firmly in place.



Codes/Standards











IAPMO/ANSI Z124.5

KOHLER® One-Year Limited Warranty

See website for detailed warranty information.

Available Color/Finishes

Color tiles intended for reference only.

| Color | Code | Description |
|--|------|---------------|
|  | 0 | White |
|  | 96 | Biscuit |
|  | 47 | Almond |
|  | NY | Dune |
|  | 95 | Ice™ Grey |
|  | G9 | Sandbar |
|  | 33 | Mexican Sand™ |
|  | K4 | Cashmere |
|  | 58 | Thunder™ Grey |
|  | 7 | Black Black™ |

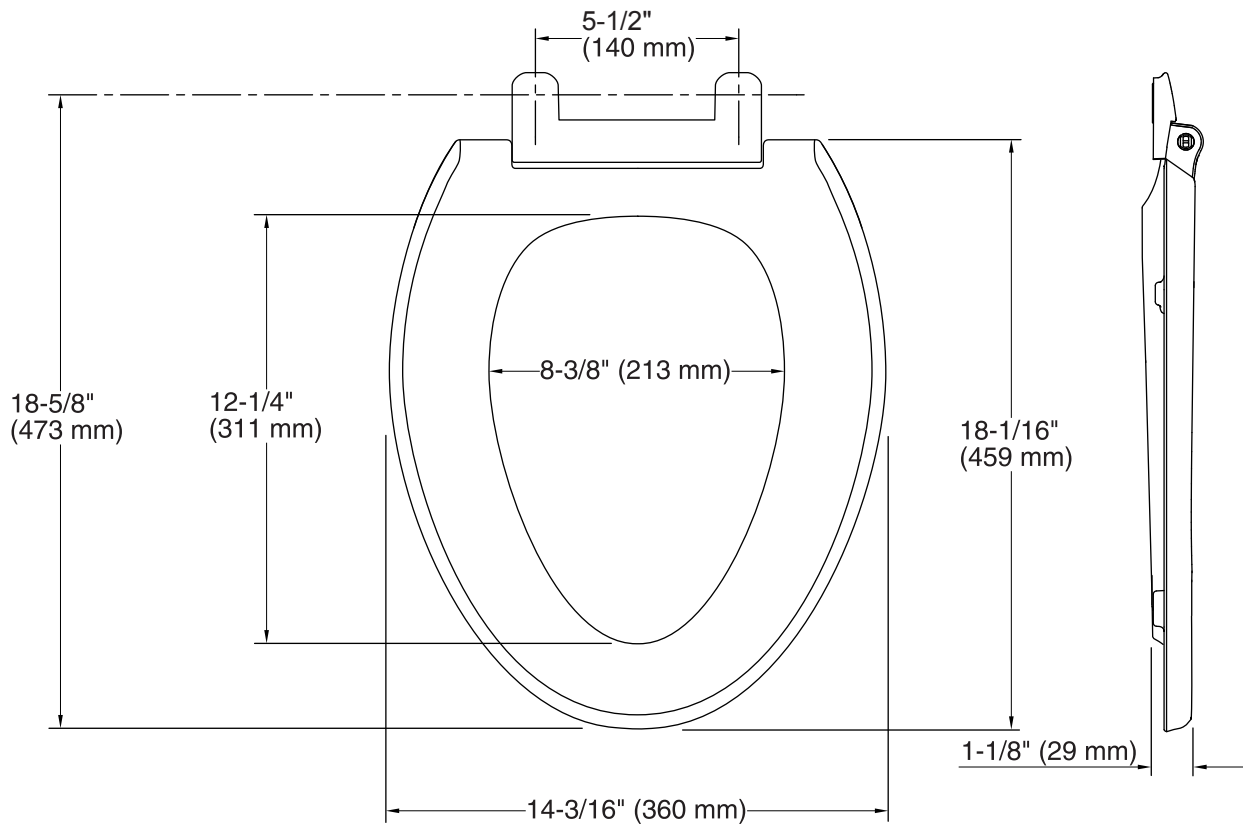

Technical Information

All product dimensions are nominal.

- Seat shape type: Elongated
Seat front type: Closed front
Seat hinge type: Quick-Attach®, Quiet-Close™, Quick-Release™
Seat-mounting holes: 5-1/2" (140 mm)

Notes

Install this product according to the installation guide.