



#### Features

- Metal construction
- Classic styling
- Includes installation hardware
- Complements Fairfax faucet line

#### Colors/Finishes

- CP: Polished Chrome
- Other: Refer to Price Book for additional colors/finishes

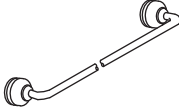
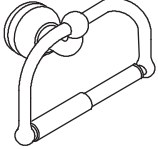
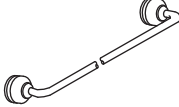
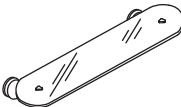
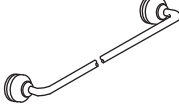
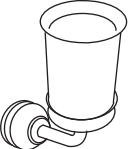
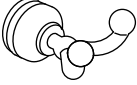
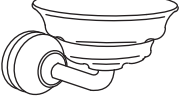
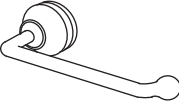
#### Specified Model

Model/Description		Model/Description	
K-12150 18" (457 mm) Towel bar <input type="checkbox"/> CP <input type="checkbox"/> Other_____		K-12157 Toilet tissue holder, horizontal <input type="checkbox"/> CP <input type="checkbox"/> Other_____	
K-12151 24" (610 mm) Towel bar <input type="checkbox"/> CP <input type="checkbox"/> Other_____		K-12158 Glass shelf <input type="checkbox"/> CP <input type="checkbox"/> Other_____	
K-12152 30" (762 mm) Towel bar <input type="checkbox"/> CP <input type="checkbox"/> Other_____		K-12161 Tumbler/toothbrush holder <input type="checkbox"/> CP <input type="checkbox"/> Other_____	
K-12153 Double robe hook <input type="checkbox"/> CP <input type="checkbox"/> Other_____		K-12162 Soap dish <input type="checkbox"/> CP <input type="checkbox"/> Other_____	
K-12155 Towel arm <input type="checkbox"/> CP <input type="checkbox"/> Other_____		K-12165 Towel ring <input type="checkbox"/> CP <input type="checkbox"/> Other_____	
K-12156 Single robe hook <input type="checkbox"/> CP <input type="checkbox"/> Other_____			

#### Product Specification

The accessories with classic styling shall be of metal construction. Accessories shall include installation hardware and complement the Fairfax faucet line. The accessories shall be Kohler Model K-\_\_\_\_\_-\_\_\_\_\_.

# FAIRFAX™

## Installation Notes



**CAUTION: Risk of personal injury.** Do not install these products in any area where they are likely to be used inadvertently as a grab bar or support bar. These products are not designed or intended for use as a grab bar or support bar.

Install this product according to the installation guide.

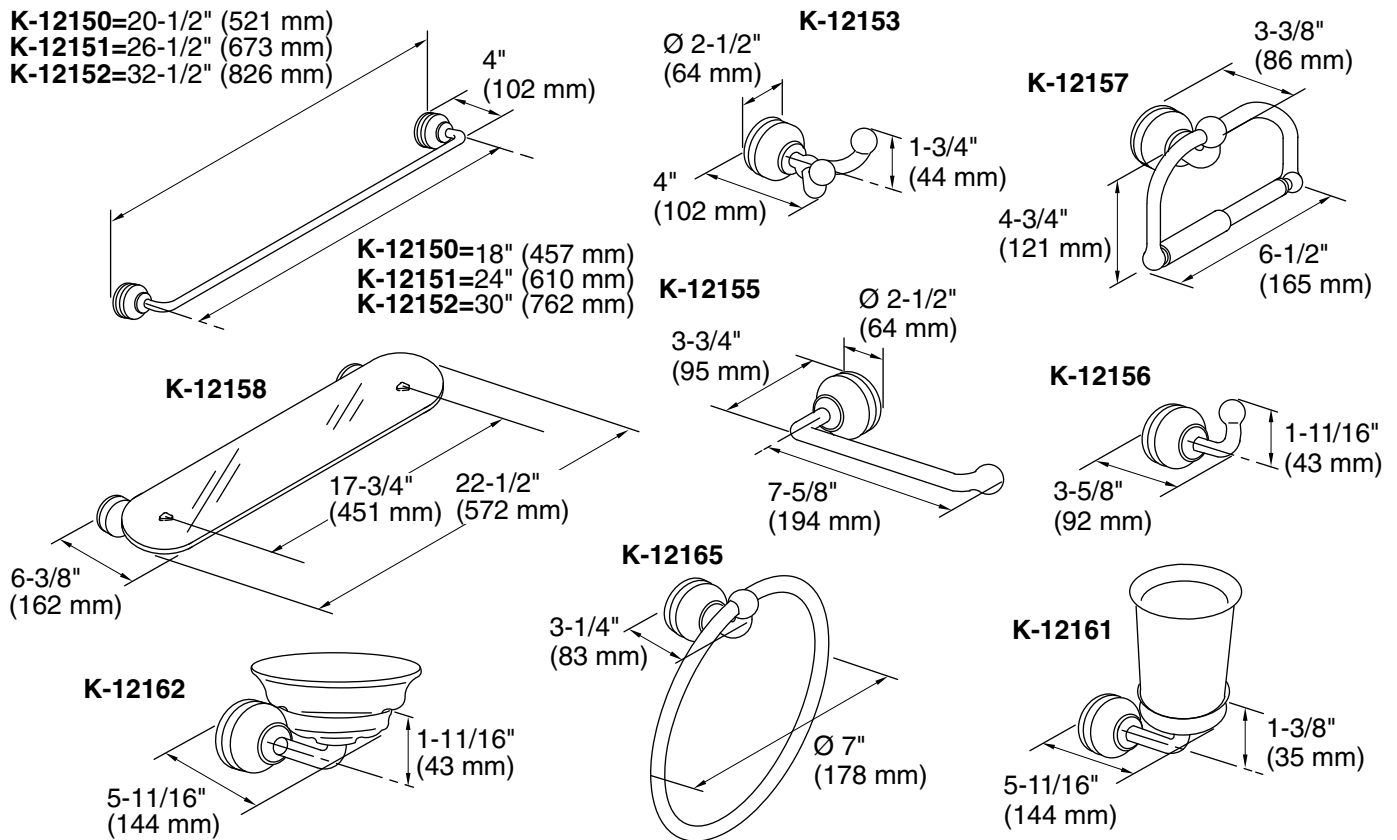

## Product Diagram