



Features

- Metal construction
- Classic styling
- Complements Forté® faucet line

Colors/Finishes

- CP: Polished Chrome
- Other: Refer to Price Book for additional colors/finishes

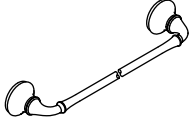
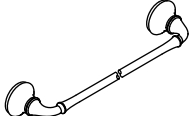
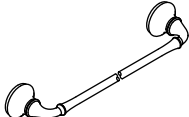
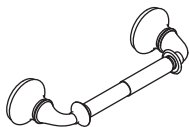
Specified Model

Model/Description	
K-11270 Forte Traditional 18" (457 mm) <input type="checkbox"/> CP <input type="checkbox"/> Other _____	
K-11271 Forte Traditional 24" (610 mm) Towel Bar <input type="checkbox"/> CP <input type="checkbox"/> Other _____	
K-11272 Forte Traditional 30" (762 mm) <input type="checkbox"/> CP <input type="checkbox"/> Other _____	
K-11274 Forte Traditional Toilet Tissue Holder, Horizontal <input type="checkbox"/> CP <input type="checkbox"/> Other _____	
K-11275 Forte Traditional Robe Hook <input type="checkbox"/> CP <input type="checkbox"/> Other _____	
K-11277 Forte Traditional Towel Ring <input type="checkbox"/> CP <input type="checkbox"/> Other _____	

Product Specification

Accessories shall be made of metal construction. Accessories shall feature classic styling. Accessories shall complement Forté® faucet line. Accessories shall be Kohler Model K-_____-_____.

FORTÉ TRADITIONAL

Installation Notes

Install this product according to the installation guide.

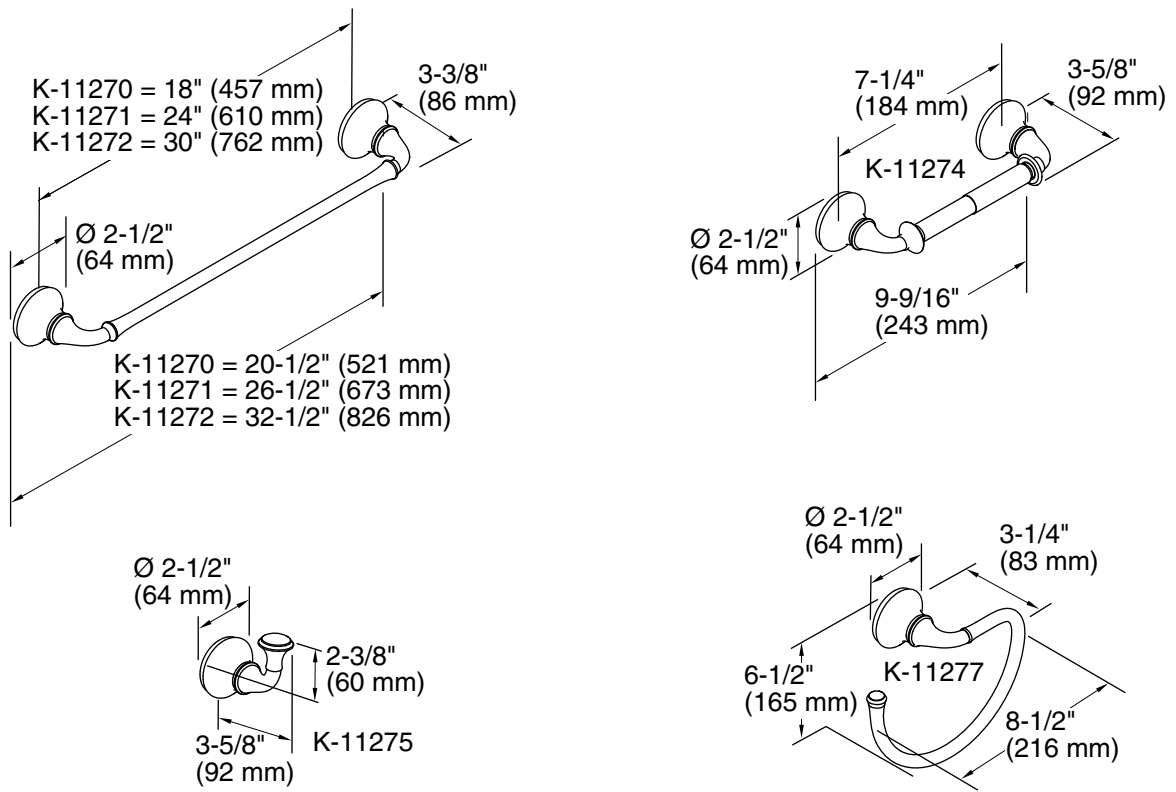

Product Diagram