

Submitted Model No.: _____

Specific Features: _____



TOUCH CLEAN SHOWERHEAD

■ Touch-Clean® Nozzles to Remove Mineral Deposits

STANDARD SPECIFICATIONS

- One to seven spray showerhead.
- Touch-Clean® nozzles to remove mineral deposits.
- 4" diameter spray face: 52625.
- 3 1/2" diameter spray face: 52678, 52635
- 3" diameter spray face: 52102.
- 2 7/8" diameter spray face: 52672.
- 2.5 GPM Maximum at 80 psi (9.5L/min @ 552 kPa)
- 2.0 GPM Maximum at 80 psi (7.6L/min @ 552 kPa).

WARRANTY

- Lifetime Faucet and Finish Limited Warranty to the original consumer purchaser to be free from defects in material and workmanship.
- 5 Year Limited Warranty for usage in all industrial, commercial and business applications.



COMPLIES WITH:

- ASME A112.18.1 / CSA B125.1
- EPA WaterSense®

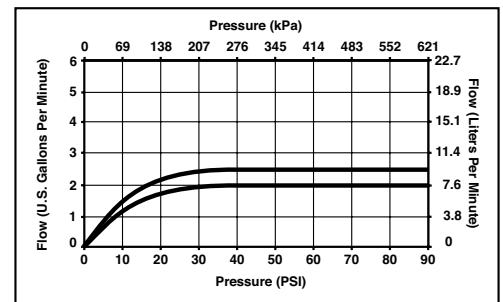

52102-▲PK 2.5 GPM Showerhead

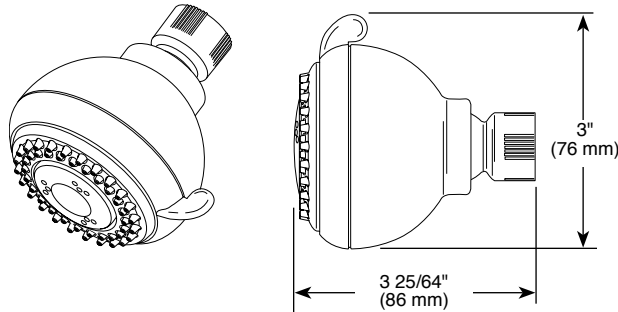
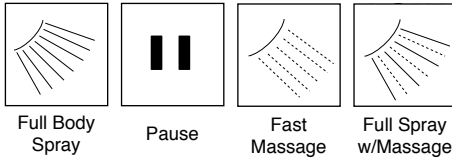

52625▲ 2.5 GPM Showerhead

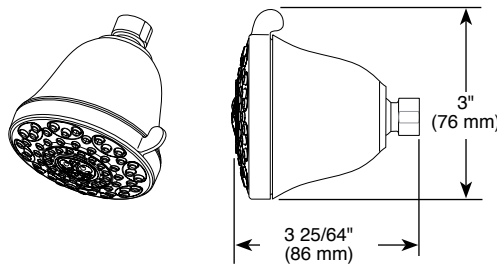
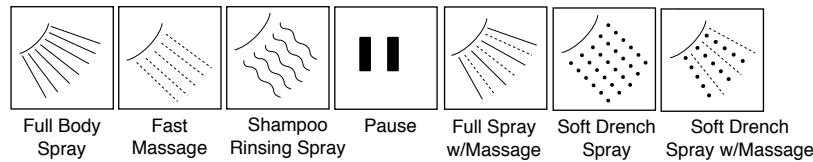

52672-▲PK 2.5 GPM Showerhead 52672-▲20-PK 2.0 GPM Showerhead

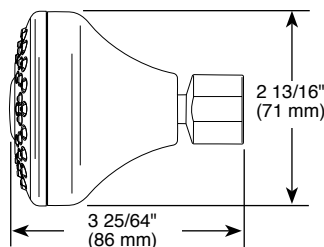
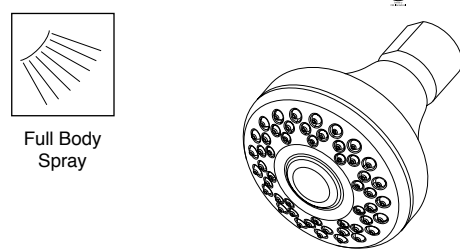

▲ Designate proper finish suffix



55 E. 111th Street, Indianapolis, Indiana 46280
350 South Edgeware Road, St. Thomas, ON N5P 4L1
© 2012 Masco Corporation of Indiana