

Vero™ Tub/Shower Trim Garniture pour Bain/Douche Vero™

Adorno Vero™ para Bañera/Ducha

Models/Modelos/Modèles T17253-H2O & T17453-H2O Series/Series/Seria

Vero™ Tub/Shower

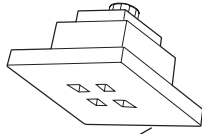

RP51032▲
Showerhead
Cabeza de Rogadora
Pomme de Douche

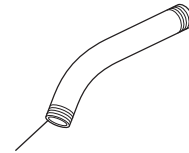

RP40593▲
Shower Arm
Brazo de la Rogadora
Tuyau de Pomme de Douche

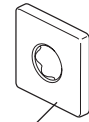

RP51034▲
Shower Flange
Pestaña de la Rogadora
Collerette

RP51035
Bracket & Screws
Abrazadera y Tornillos
Support et Vis

RP196▲
Trim Screws/Atornillos de
Franja/Vis de Finition
RP12630▲
For Longer Screws
Para Tornillos Más Grandes
Pour Vis Plus Longues

★**RP46463**
Cartridge Assembly
Cartucho
Cartouche

RP50880▲
Trim Sleeve
Manga de Franja
Manchon de Finition

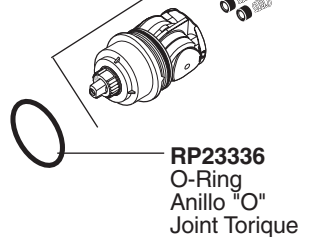

RP23336
O-Ring
Anillo "O"
Joint Torique

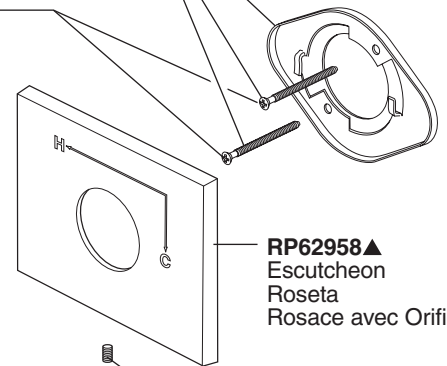

RP62958▲
Escutcheon
Roseta
Rosace avec Orifice

RP51019
Set Screw
Tornillo de Ajuste
Vis de Calage

RP32105
Screw/Tornillo/Vis

NOTE: Do NOT overtighten screw.

NOTA: NO apriete demasiado el tornillo.

NOTE : NE serrez PAS trop la vis.

RP32102
Rotational Limit Stop
Tope para Limitar
Butée Rotative

RP28598
Decal (Red/Blue)
Etiqueta (Rojo/Azul)
Etiquette (Rouge/Bleu)

RP62957▲
Handle Assembly
Ensamble de la Manija
Poignée

RP62956▲
Temperature Knob and Cover
Perilla de la Temperatura y Cubierta
Poignée de Réglage de Température

RP53421▲
Tub Spout–Pull-Up Diverter
Tubo de Salida para Bañera–
Botón Desviador de Alzar
Bec avec dérivation à tirette

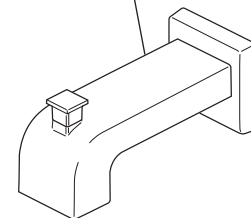

▲Specify finish / Especificque el Acabado / Précisez le fini

*Refer to page 2 for more information. / Consulte con la página 2 para más información. / Pour obtenir de plus amples renseignements, reportez-vous à la page 2.

51975 Rev_H_T17453-H2O_T17253-H2O

T17 SERIES

Cartridge Summary Reference Sheet

Units shipped in March 2006 and after.

MultiChoice® 13/14

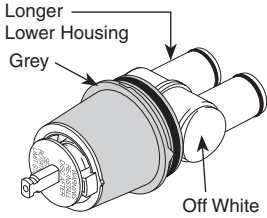

Order RP46074 to Replace Cartridge.

Units shipped before March 2006.

Old Monitor® 1300/1400

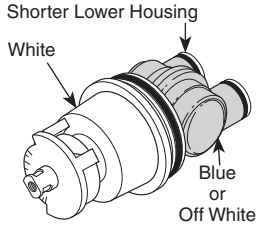

Order RP19804 to Replace Cartridge.

Replacement cartridges shipped in July 2006 and after.

New Monitor® 1300/1400

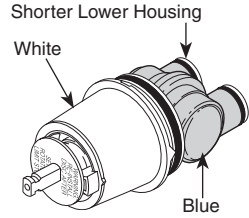

Order RP19804 to Replace Cartridge.

17

Grey Upper Cap

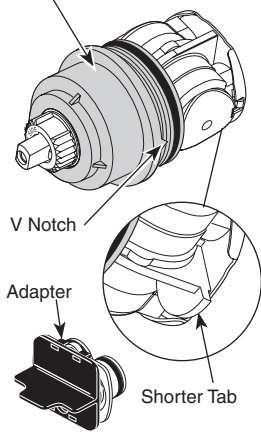

Order RP46463 to Replace Cartridge.

1700

White Upper Cap

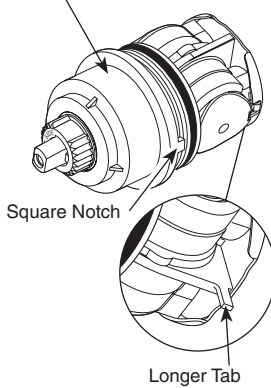

Order RP32104 to Replace Cartridge.

NA

17T

Brass

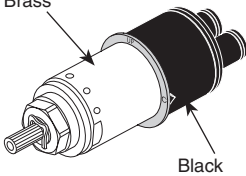

Order RP47201 to Replace Cartridge.

NA
Will Not Fit

NA