

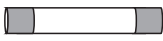













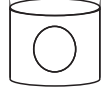





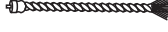

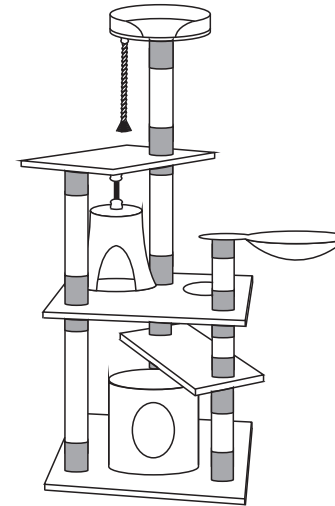
**PLEASE NOTE:** IT WILL BE BEST TO SORT AND GROUP ALL THE SAME SIZE POSTS ACCORDING TO THEIR LENGTH AND DIFFERENT PARTS TOGETHER PRIOR TO INSTALLATION

A ∅3"*23.6"  1pc	B ∅3"*15"  2pcs	C ∅3"*17.7"  2pcs	D ∅3"*15.7"  1pc
E ∅3"*7.9"  2pcs	F ∅3"*9.5"  1pc	G 23"*19"  1pc	H ∅12"*H9.5"  1pc
I 21"*11.5"  1pc	J 23"*19"  1pc	K 21"*11.5"  1pc	L ∅12"  1pc
M ∅13"*H2.8"  1pc	N ∅11"*H12.5"  1pc	O L16"  1pc	P  1pc

**F-208**



		1pc
 W1	∅ 0.31"*1.1"	1pc
 W2	∅ 0.31"*1.57"	5pcs
 W3	∅ 0.31"*1.37"	1pc
 W4	∅ 0.31"*3.1"	6pcs
 W5	∅ 0.23"*1"	1pc
 W6	∅ 1.1"	1pc

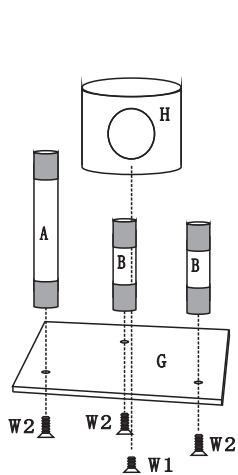

**step 1**

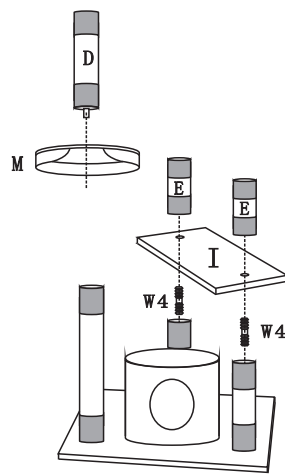

**step 2**

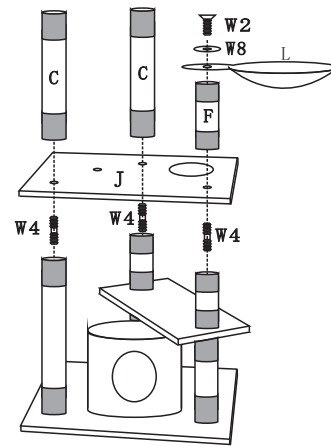

**step 3**

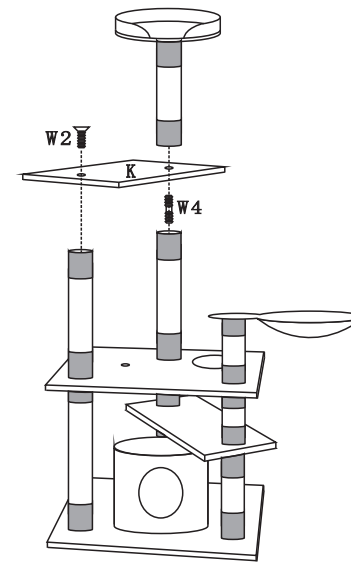

**step 4**

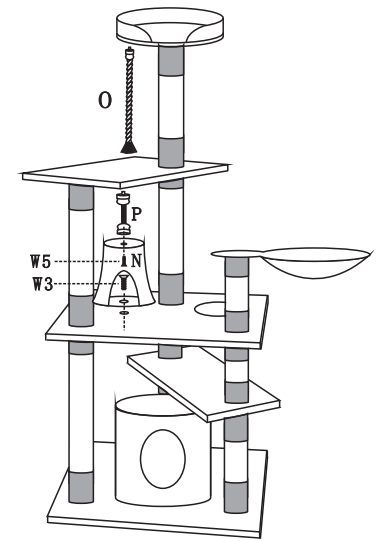

**step 5**