









PLEASE NOTE: IT WILL BE BEST TO SORT AND GROUP ALL THE SAME SIZE POSTS ACCORDING TO THEIR LENGTH AND DIFFERENT PARTS TOGETHER PRIOR TO INSTALLATION



F-63

<p>A</p> <p>∅3" * 15.7"</p>  <p>4pcs</p>	<p>B</p> <p>∅3" * 21.6"</p>  <p>1pc</p>	<p>C</p> <p>∅3" * 15.7"</p>  <p>1pc</p>
<p>D</p> <p>23" * 19"</p>  <p>1pc</p>	<p>E</p> <p>23" * 19"</p>  <p>1pc</p>	<p>F</p> <p>∅13.5" * H2.8"</p>  <p>1pc</p>
<p>G</p> <p>14" * 12" * H13.5"</p>  <p>1pc</p>	<p>H</p>  <p>1pc</p>	<p>I</p> <p>∅13.5"</p>  <p>1pc</p>

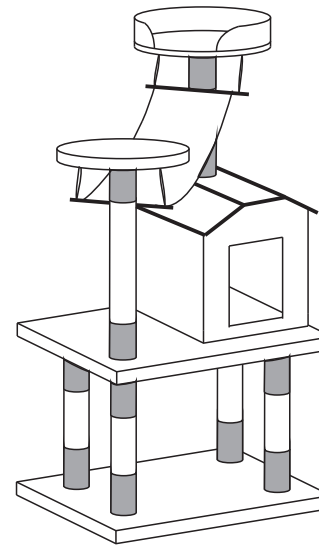

		1pc
	∅0.31" * 3.1"	1pc
	∅0.31" * 1.57"	8pcs
	∅0.31" * 1.37"	1pc
		4pcs

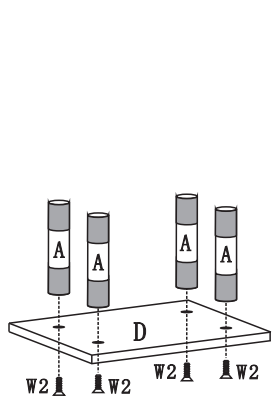

step 1

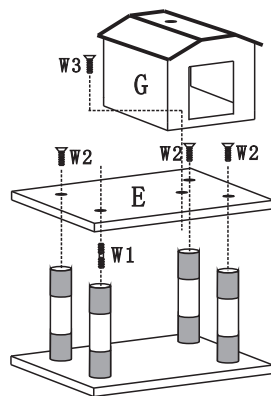

step 2

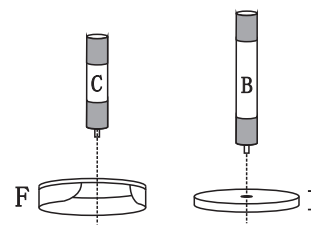

step 3

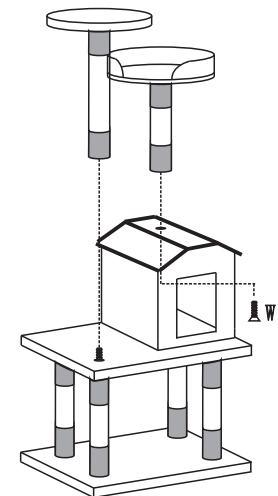

step 4

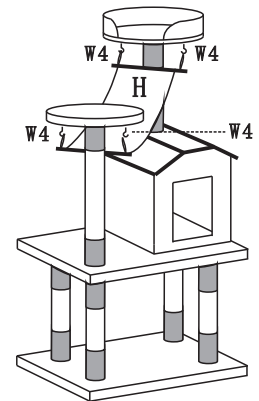

step 5