



Paws Aboard Doggy Boat Ladder

Patented

INSTRUCTIONAL MANUAL

- 
- **Portable, Lightweight & Durable Design**
 - **Folds in Half for Easy Storage & Transport**
 - **Corrosion Proof – UV Resistant**
 - **Dogs Love It – Makes Boating Safe and Fun for You and Your Dog**
 - **Ladder Measurements:**
 - *Folded Length: 32 in. \ 81 cm.*
 - *Unfolded Length: 63³/₄ in. \ 162 cm.*
 - *Width: 16 in. \ 40 cm.*
 - *Weight: 18 lbs. \ 8 kg.*

Paws Aboard Customer Service

If you have trouble fitting your Doggy Boat Ladder to your boat or have any questions, please feel free call us:

United States:
toll-free: 1-877-987-PAWS (7297)

International Calls:
+1-317-895-2706

Product Support:
For product support, e-mail us at
CustomerService@PawsAboard.com

Sales and Marketing Information:

For sales and marketing information, e-mail us at
Info@PawsAboard.com



DOGGY BOAT LADDER (Setup & Attached View) — Model 5200

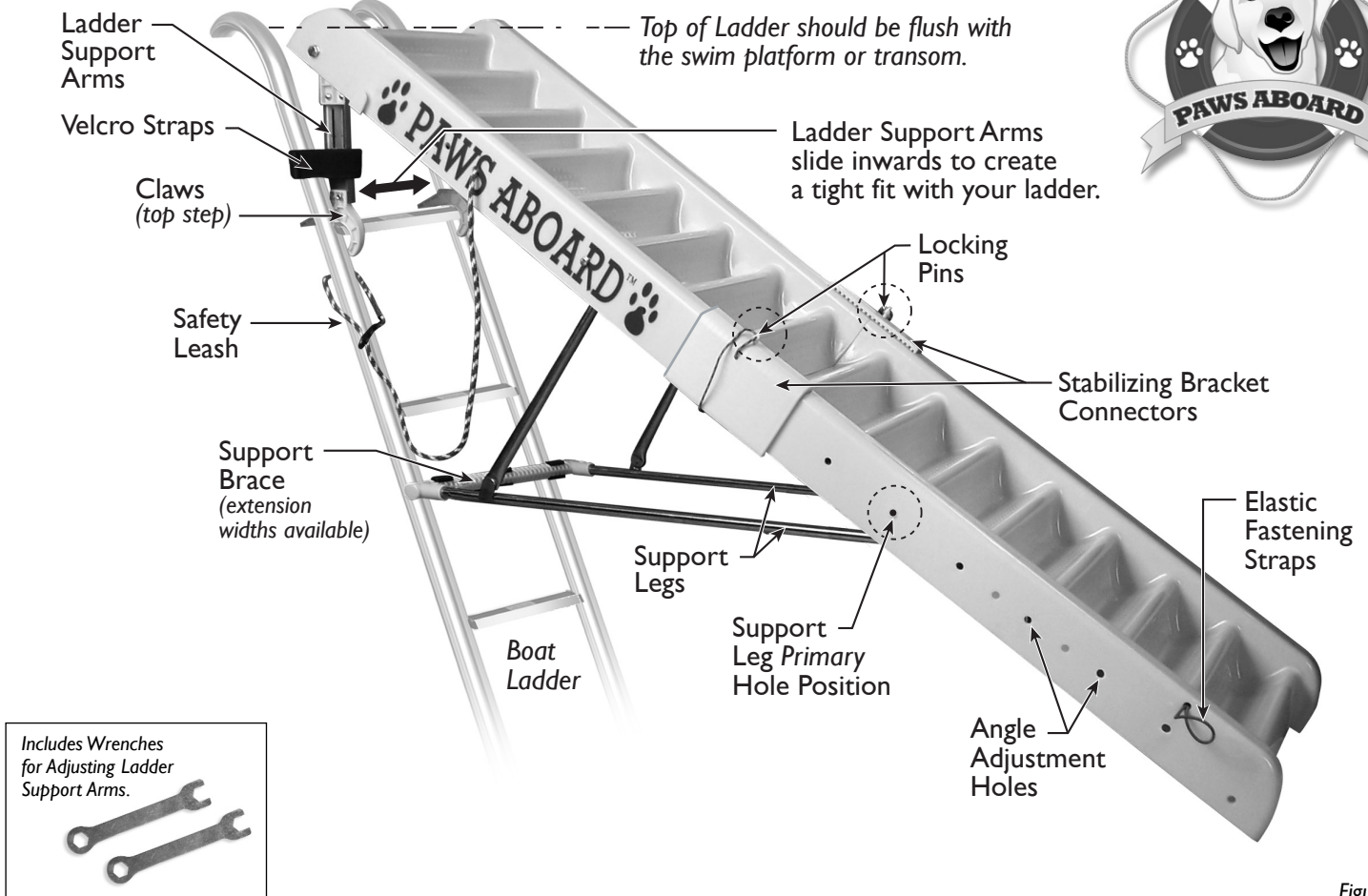

Figure 1

OPENED LADDER (Inside Storage View) — Model 5200

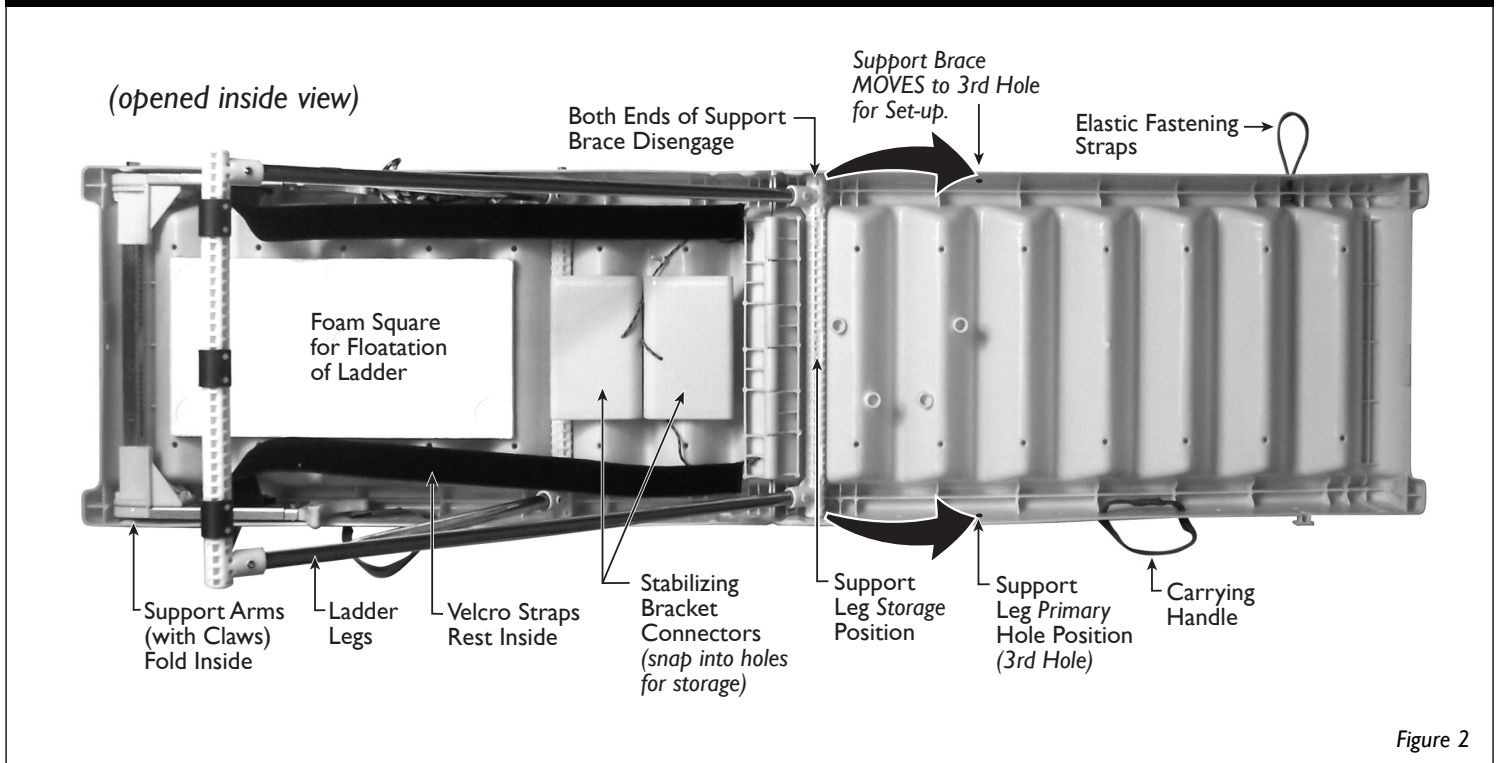

Figure 2

Ladder Setup Instructions

Preparing the Ladder

- Boat Ladder Measurements.** Measure the distance between the top of the boat's ladder and the top step of the ladder (see *Figure 3*). When installed, the top of the doggy boat ladder should meet up to the bottom of the swim platform or transom (refer to *Figure 1*).

Note: Your boat ladder MUST be less than 14" (35cm) wide for proper Doggy Boat Ladder attachment. If your boat ladder is wider than this, call us toll-free to order an "Extension" Support Piece.

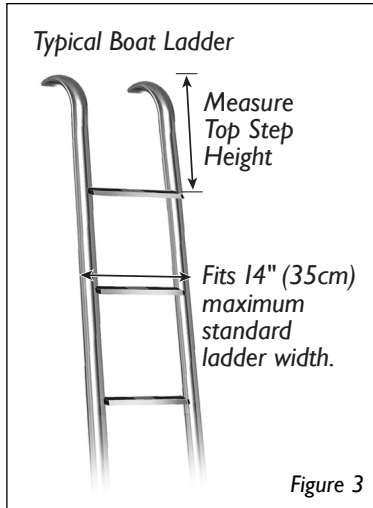

- Preparing the Doggy Ladder.** Place the ladder with logo upside down to open unit. Next, unlatch Elastic Fastening Straps on both sides of the ladder (*Figure 4*) and open.

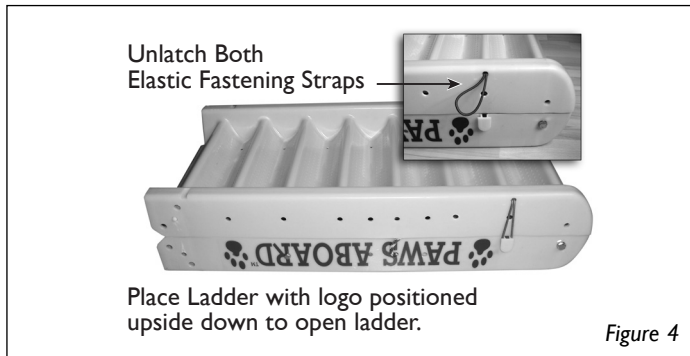

- Move the Support Legs down two holes to the "Primary" Hole Position (*Figure 5*).**

Note: Depending on your boat's position in the water, you may need to move the support legs to a different adjustment hole. This will change the angle of the ladder making it easier for your dog to board.

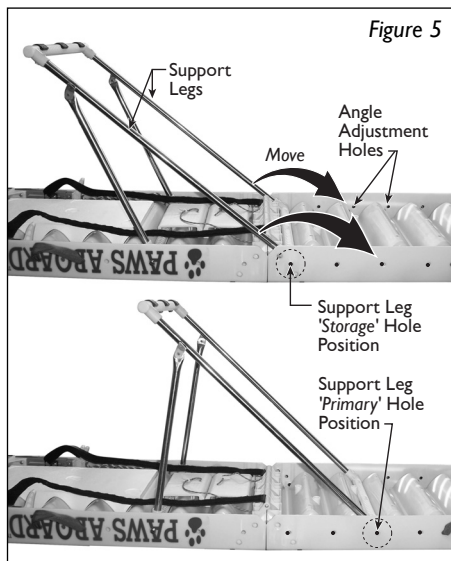

- Remove the two side Stabilizing Bracket Connectors** and insert them in the appropriate mounting holes on both sides of the ladder to affix the two ladder halves together. **Note:** The Stabilizing Brackets have two tabs on the underside of each bracket. Take care that the tabs are positioned on the inside of the ladder.

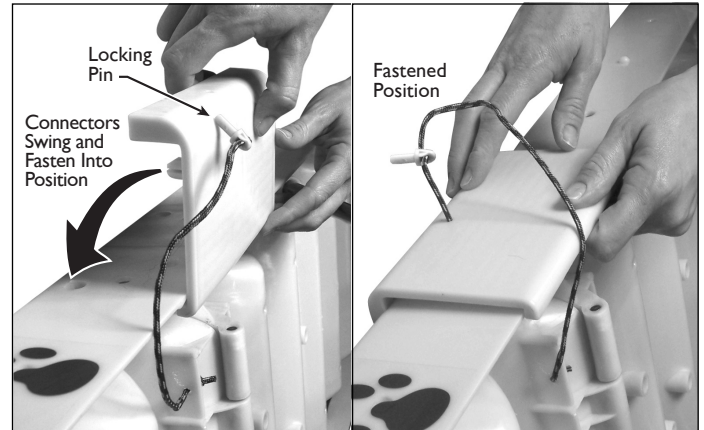
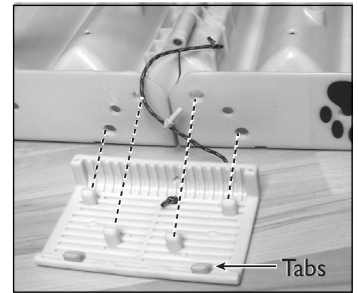

- Insert the two Locking Pins** into the Stabilizing Bracket's TOP SIDES - and secure pin as shown in *Figure 6*. **Note:** You may need to squeeze hole some to insert pin completely.

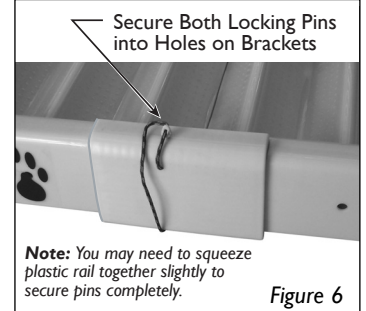

- Flip up the Ladder Support Arms** of your Doggy Boat Ladder into the vertical 'set' position (*Figure 7*).

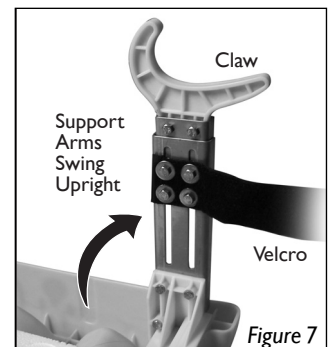

- Adjusting Support Arms Length (optional)** You will need to adjust the length of the Support Arms to match the distance measured in Step #1 for ladder step height (refer to *Figure 3*). Use the two provided wrenches (*Figure 8*) to loosen the four bolts (w/ Velcro attached to them) and SLIDE the Support Arms to match the distance from Step #1. Do the same to BOTH Support Arms and fasten bolts securely when satisfied with this height.

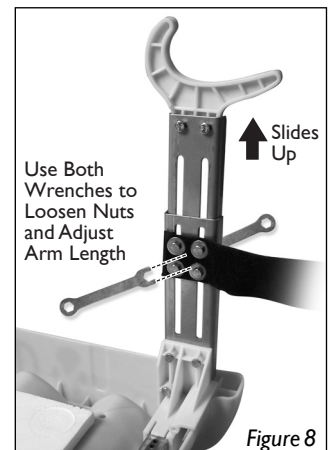

8. **If your Support Arms are too long for your boat ladder configuration**, simply remove the top plastic claw and sliding arm section. Next, reattach **ONLY** the Claw portion onto the lower stationary arm brace. This will allow for a shorter arm (Figure 9).

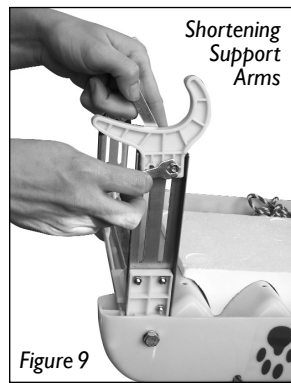

9. **CONGRATULATIONS! Your Doggy Boat Ladder is now ready to be attached** to your boat. When installed properly, the **TOP** of the Doggy Boat Ladder should **ALIGN** flush with the swim platform or transom (see Figure 10).

Attaching the Doggy Boat Ladder to Your Boat

1. Make certain that the Support Arms and the Support Legs are in their upright position (Figure 10). Verify both Stabilizing Brackets and Locking Pins are also in place (see Figure 6).
2. With the ladder fully extended, set the Support Arm Claws on the **TOP STEP** of the boat ladder. Holding the ladder with one hand, use your other hand to wrap the Velcro straps around both the boat ladder side rails and the Support Arms of the Doggy Boat Ladder. Be sure that the doggy ladder sits snugly against the boat.

Note: The Support Arms adjust and slide inwards for creating a secure fit to your boat ladder.

Note: If the Doggy Boat Ladder does not seem secure against the boat's ladder, you may need to adjust the Doggy Boat Ladder's Velcro straps at this point.

Note: The **TOP** of the Doggy Boat Ladder should be **FLUSH** with the swim platform or transom for your dogs to enter and exit the boat correctly.

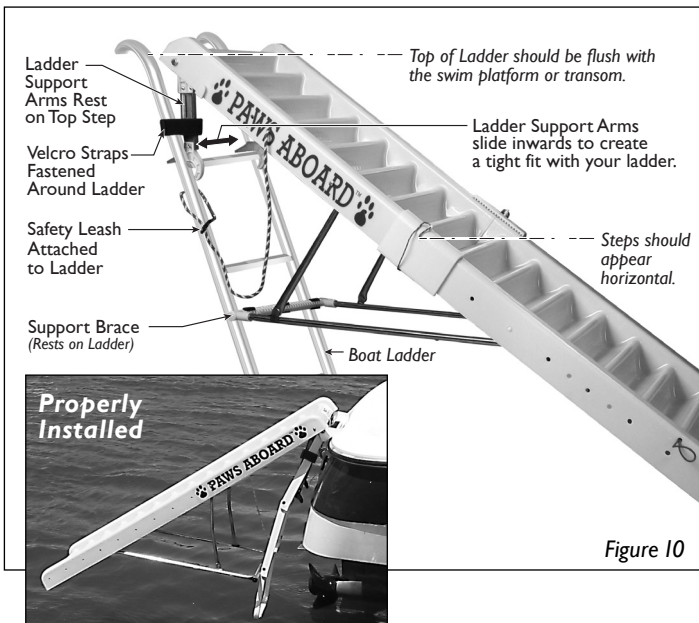

3. **Attach the Doggy Boat Ladder Safety Leash** to the boat to reduce the risk of losing the ladder (Figure 10).
- Note:** If you find the angle of the Doggy Boat Ladder 'angle' needs adjusted, move the bottom Support Legs to a different hole. The ideal angle of the ladder positions the steps as level (Figure 11).

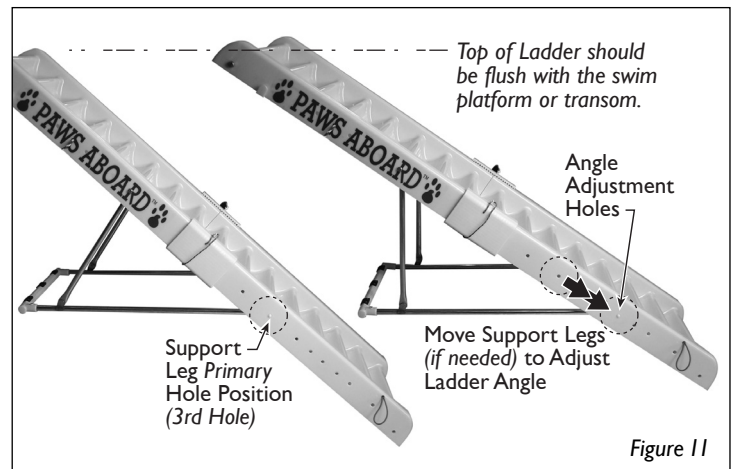

Temporarily Detaching the Doggy Boat Ladder

If humans want to use the boat's ladder, the Doggy Boat Ladder can be easily detached by simply following these steps. **Note:** The Doggy Boat Ladder is **NOT** intended for human use.



1. Release the two Velcro straps, pull the ladder "up" slightly and let the ladder float off to the side while you use the boat's ladder. The Safety Leash will keep the ladder attached to the boat (Figure 12).

To Reattach the Boat Ladder:

1. Pull the Doggy Boat Ladder's Leash to retrieve the ladder.
2. Lift the ladder up and set the Ladder Claws on the top step of the boat ladder - and then reattach the two Velcro Straps to your boat's ladder as described earlier.



Note: The Doggy Boat Ladder should **ALWAYS** be removed **BEFORE** moving your motor boat through the water.

Storage Instructions

The Doggy Boat Ladder can be stored easily in your boat or in the trunk of your car. Follow these steps for storage of the Doggy Boat Ladder:

1. Turn the ladder upside down (steps facing down).
2. Remove the two Stabilizing Bracket Locking Pins. Next, unclip the two Stabilizing Side Brackets and place them as shown in Figure 13. (**Note:** the Side Support Brackets have tabs which 'snap' into holes on the back of the ladder for storage).
3. Move the bottom Support Brace Legs BACK into the top slot 'storage' position for proper ladder storage (reference Figure 5).
4. Lay Support Arms down inside housing.
5. Place the two Velcro straps on top of the foam flotation piece as shown in Figure 13.
6. Coil and tuck Safety Leash back inside housing.
7. Fold the Doggy Boat Ladder back in half (all pieces should be contained within the folded ladder now). Next, secure the two elastic straps around their posts to secure ladder together completely.
8. You can now carry and store the Doggy Boat Ladder safely.



Care and Maintenance of the Doggy Boat Ladder

Maintaining your Paws Aboard Doggy Boat Ladder is easy. If it has been in saltwater, simply rinse the ladder with freshwater. The ladder is made of plastic and stainless steel, so corrosion is not a problem. Make sure there is no sand or dirt remaining in the ladder before you store it.

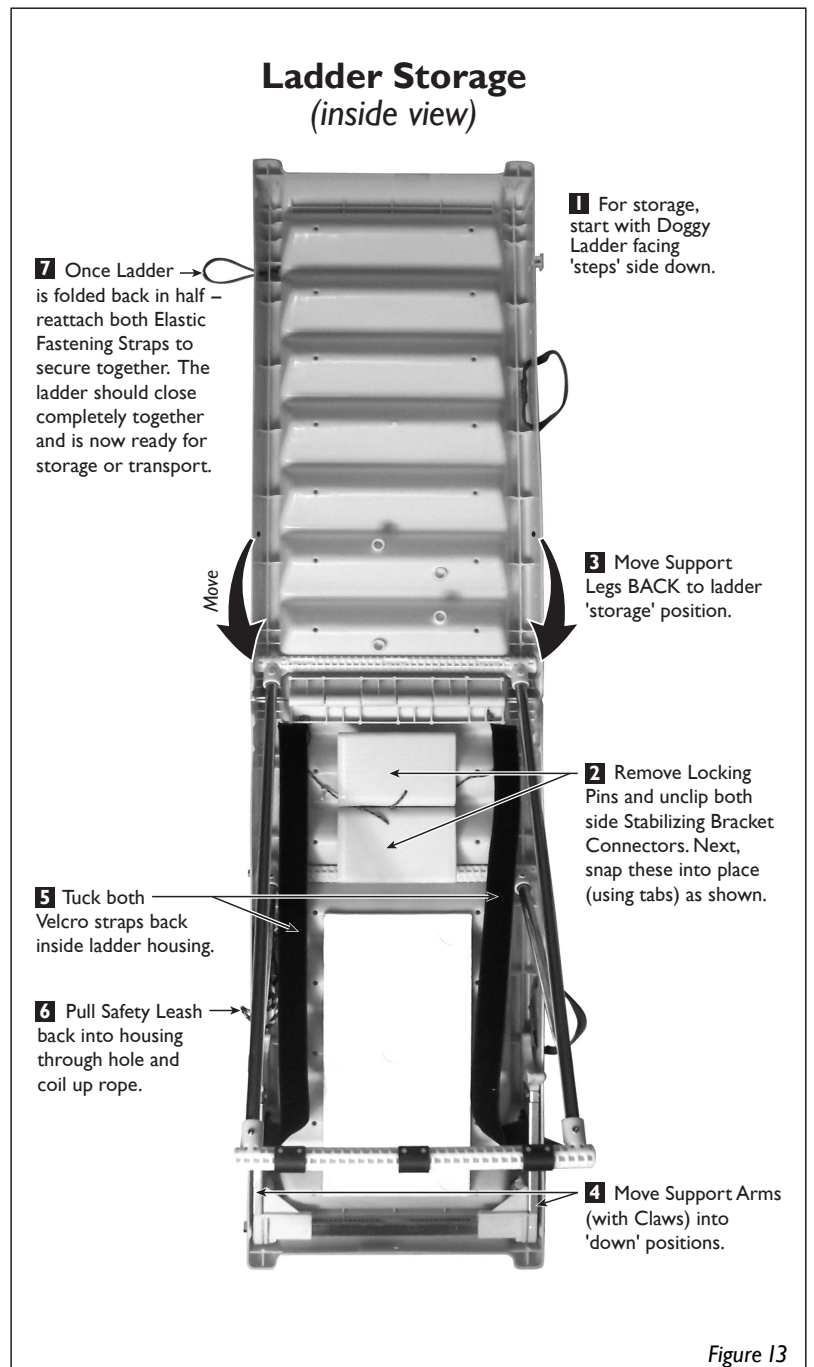

Figure 13



PAWS ABOARD TRANSFERABLE LIMITED WARRANTY

PRODUCTS AND PERSONS COVERED

This Limited Warranty (the "Warranty") covers your Paws Aboard doggy ladder product ("Warranted Product") purchased from a dealer authorized by Paws Aboard. The warranty is extended to the original owner of the Warranted Product and can be transferred to successive owners of the product ("Owner").

TERMS OF LIMITED WARRANTY

Subject to the limitations and exclusions set forth below, Paws Aboard warrants to the Owner that the Warranted Product, will meet the standards identified herein for a period of ONE (1) year, providing the Owner has adequately maintained the product according to Paws Aboard's recommendations.

STANDARDS

This Limited Warranty shall cover the Warranted Product to the extent that the Warranted Product does not conform with the original manufacturer's specifications and commercially reasonable workmanship standards.

REMEDIES

If a Warranted Product fails to meet the standard, then Paws Aboard, upon receiving a bona fide warranty claim, will, subject to the limitations and exclusions set forth below, repair the existing Warranted Product, or, if repairing the Warranted Product does not bring the Warranted Product to a level consistent with the manufacturer's specifications, Paws Aboard shall furnish a replacement Warranted Product. In no circumstances, however, shall the retail value of the repair work or replacement work exceed the original cost of the Warranted Product. Additional work may be performed upon request of the Owner at the Owner's sole expense. This remedy is the exclusive remedy available under this warranty.

LIMITATIONS AND EXCLUSIONS

This warranty shall not be effective unless each and every piece of Warranted Product was provided by an authorized Paws Aboard dealer.

This warranty is void if there is:

1. Improper Care after Installation. Warranted Product's failure due to Owner's lack of improper care.

2. Improper Use.

(A) Human Use. Warranted Product's failure due to use by humans. Paws Aboard is intended for dog use only. Ladder is not intended for human use. Injury to person and injury to the boat may occur. Carefully remove the ladder and securely store before any human attempts to enter or exit the boat while using the existing apparatus. Be sure to warn any and all guests that the ladder should not be used by humans.

(B) Use by dogs in excess of ONE-HUNDRED and THIRTY POUNDS (130 lbs.). Warranted Product's failure due to use by dogs weighing in excess of 130 lbs.

(C) Non-removal of Warranted Product while boat is moving in water. Warranted Product's failure due to failure to remove the Warranted Product from the water while the boat is in motion. Carefully remove the ladder and securely store the Warranted Product before putting the boat in motion.

(D) Non-removal of Warranted Product while transporting boat. Warranted Product's failure due to failure to remove the Warranted Product from the boat while transporting the boat. Carefully remove the ladder and securely store the Warranted Product before transporting the boat.

(E) Use of Warranted Product in heavy wake. Warranted Product's failure due to use in heavy wake. This may result in injury to the dog and/or damage to the boat. Carefully remove the ladder and securely store the Warranted Product before use in a heavy wake.

(F) Subjection of Warranted Product to extreme temperatures. The Warranted Product should not be subjected to temperatures below ten degrees Fahrenheit or in excess of ninety-eight degrees Fahrenheit.

3. Modifications. Warranted Product's failure due to repairs or alterations made by any party other than an authorized Paws Aboard dealer after its original sale.

This warranty does not cover:

1. Direct or Indirect Damage from Natural Causes. Warranted Product's failure due to hurricane, tornado, hail, lightning, flood, explosion, mudslide, earthquake, volcanic eruption, falling objects, aircrafts, vehicles, boats, accidents, riots, civil commotion, war or acts of God.

2. Damage by objects in water. Any damage due to objects in and/or on lakes, ponds, oceans, pools, and/or docks that come in contact with the Warranted Product.

3. Other Acts. Any damage to the Warranted Product as a result of the human or animal acts, regardless of intention, including, but not limited to, use of other water craft, use of machines and equipment, use of sporting equipment and lack of animal control.

DISCLAIMER AND LIMITATION OF LIABILITY

THIS WARRANTY IS IN LIEU OF ANY OTHER WARRANTY, ORAL OR WRITTEN, EXPRESSED OR IMPLIED, AND, EXCEPT AS EXPRESSLY PROVIDED HEREIN, PAWS ABOARD DISCLAIMS ALL OTHER WARRANTIES OR REPRESENTATIONS, INCLUDING BUT NOT LIMITED TO, ANY IMPLIED WARRANTY OR MERCHANTABILITY OR FITNESS FOR A PARTICULAR PURPOSE. PAWS ABOARD SHALL NOT BE LIABLE FOR ANY INCIDENTAL, CONSEQUENTIAL, PERSONAL OR PROPERTY DAMAGES RESULTING FROM WARRANTED PRODUCT COVERED BY THIS WARRANTY OR ITS INSTALLATION. SOME STATES DO NOT ALLOW LIMITATIONS ON HOW LONG AN IMPLIED WARRANTY LASTS OR THE EXCLUSION OR LIMITATION OF INCIDENTAL OR CONSEQUENTIAL DAMAGES, SO THE ABOVE LIMITATIONS MAY NOT APPLY TO YOU. THIS WARRANTY GIVES YOU SPECIFIC LEGAL RIGHTS, AND YOU MAY HAVE OTHER RIGHTS WHICH VARY FROM STATE TO STATE.

CLAIM PROCEDURE

To make a claim under this warranty, the Owner must, within thirty (30) days after discovery of alleged defect to which the claim relates, contact Paws Aboard, Inc. And obtain return authorization. The contact information is as follows:



Paws Aboard Inc.
9850 East 30th Street
Indianapolis, IN 46229
877-987-PAWS (7297)
1+317-895-2706
www.PawsAboard.com

Do not return product until authorization is obtained.

Paws Aboard reserves the right to have a representative inspect all Warranted Products that are claimed to be defective under the terms of this Warranty. Any alteration, removal, or repair of material claimed to be defective prior to settlement of the claim shall bar any right to seek relief under this Warranty.

ENTIRE WARRANTY

This document contains the entire warranty and may not be altered by any wholesaler, dealer or representative. Of course, any wholesaler, dealer or representative is free to offer its own independent warranty.