



## Atlas™ 12 ft x 20 ft

12 ft 6 in Wide x 20 ft Deep x 6 ft 2 in Side Height /  
8 ft 2 in Center Height



### King Canopy Item # AT1220S

With 8 Legs, Cover with Side Walls, 2 Zippered End Walls,  
Woven Steel™ Roof Cables, Elastic Ball Straps, Foot Pads and Anchors.

These Tools Are  
Recommended:













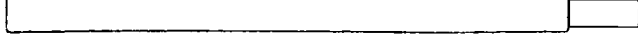
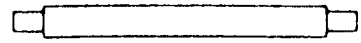
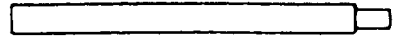

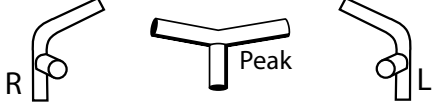
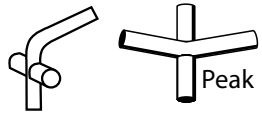
#### **WARNING:**

Keep all flame and heat sources away from this tent fabric. Meets the flammability requirements of CPAI-84 Section 6 and NFPA-701. It is not fire proof. The fabric will burn if left in continuous contact with any flame source.

Distributed by:  
PIC America, LTD.  
1730 Five Points Lane • Fuquay-Varina, NC 27526  
1-800-800-6296 • [www.kingcanopy.com](http://www.kingcanopy.com)

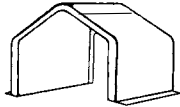
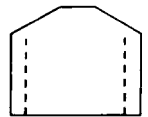

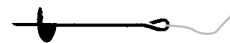
# PARTS LIST

<b>3X4-2PCS-AT-A</b>	16 pc	2"x39.5" Silver Swedge Pipe	
<b>2X0-2PCS-AT-B</b>	8 pc	2"x23.75" White Swedge Pipe	
<b>2X7-2PCS-AT-C</b>	8 pc	2"x31.125" Silver Swedge Pipe	
<b>3X4PCS-AT-D</b>	15 pc	1.375"x39.75" Silver Pipe	
<b>3X4PCS-AT-E</b>	15 pc	1.375"x39.75" Silver Swedge Pipe	
<b>3W2PCS-AT-R</b>	2 pc	3-way Connectors - Silver Right Side	
<b>3W2PCS-AT-L</b>	2 pc	3-way Connectors - Silver Left Side	
<b>3W215PC-AT</b>	2 pc	3-way Connectors - White (Peak Ends)	
<b>4W2PCS-AT</b>	4 pc	4-way Connectors - Silver (Sides)	
<b>4W215PC-AT</b>	2 pc	4-way Connectors - White (Peak)	
<b>SC215-AT</b>	4 pc	3-way clamp	
<b>DC215-AT</b>	4 pc	4-way clamp	
	16 pc	5/16" x 2.5" Bolts	
	12 pc	5/16" x 2" clamp bolts	
	28 pc	5/16" Nuts & washers	
<b>BALL</b>	65 pc	Elastic ball straps	
<b>ATC1220S</b>	1 pc	Fitted Cover with attached sidewalls	
<b>AT12047EWZS</b>	2 pc	End walls with zippers	
<b>FOOT2PCS-AT</b>	8 pc	Foot pads	
<b>A15-CC</b>	8 pc	Anchors with cable	
<b>U-CLAMP</b>	8 pc	U-clamps for Anchors	
<b>CBL-AT</b>	4 pc	Woven Steel™ Cable	

# ROOF FRAME ASSEMBLY



## Step A

Separate all pieces for the roof section first according to size and shape and arrange per the illustration shown below.

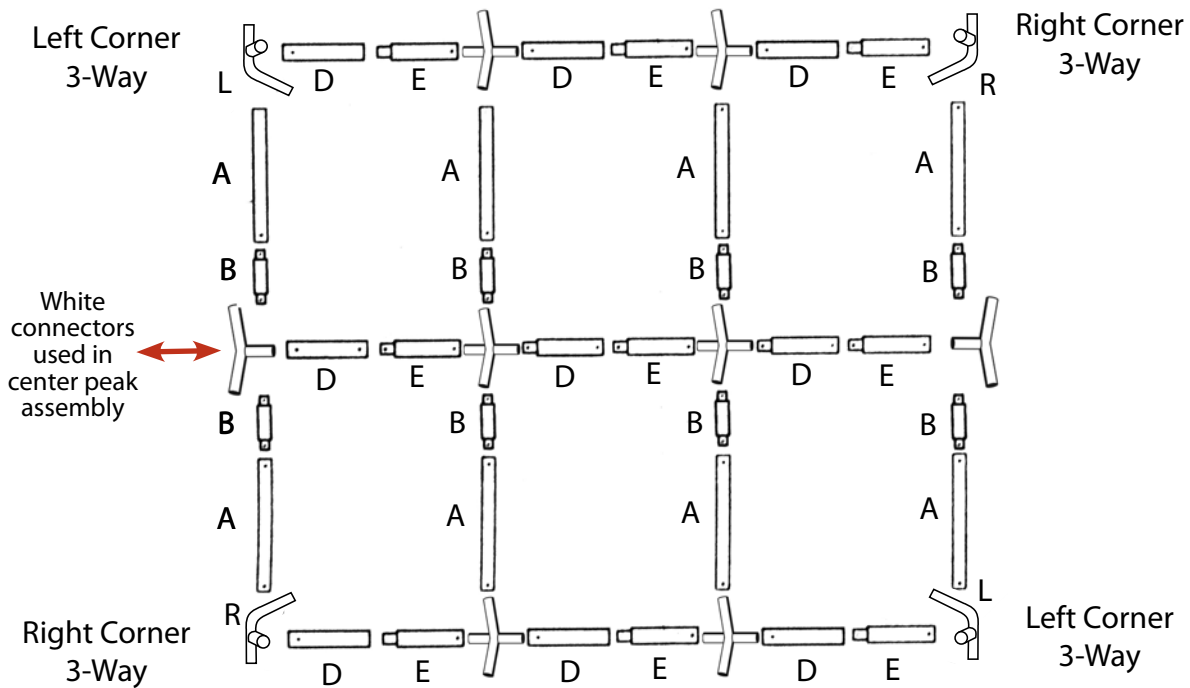

## Step B

Start with the center and complete the center frame first. Then assemble each side. You will be using the 5/16"x2.5" bolts and nuts for the roof frame assembly. Make sure the bolt holes in the pipes are aligned and facing away from the cover so they do not make contact with cover and puncture it. Also at this point you will need to install the Woven Steel™ Cable at each roof truss section before totally closing up each section.

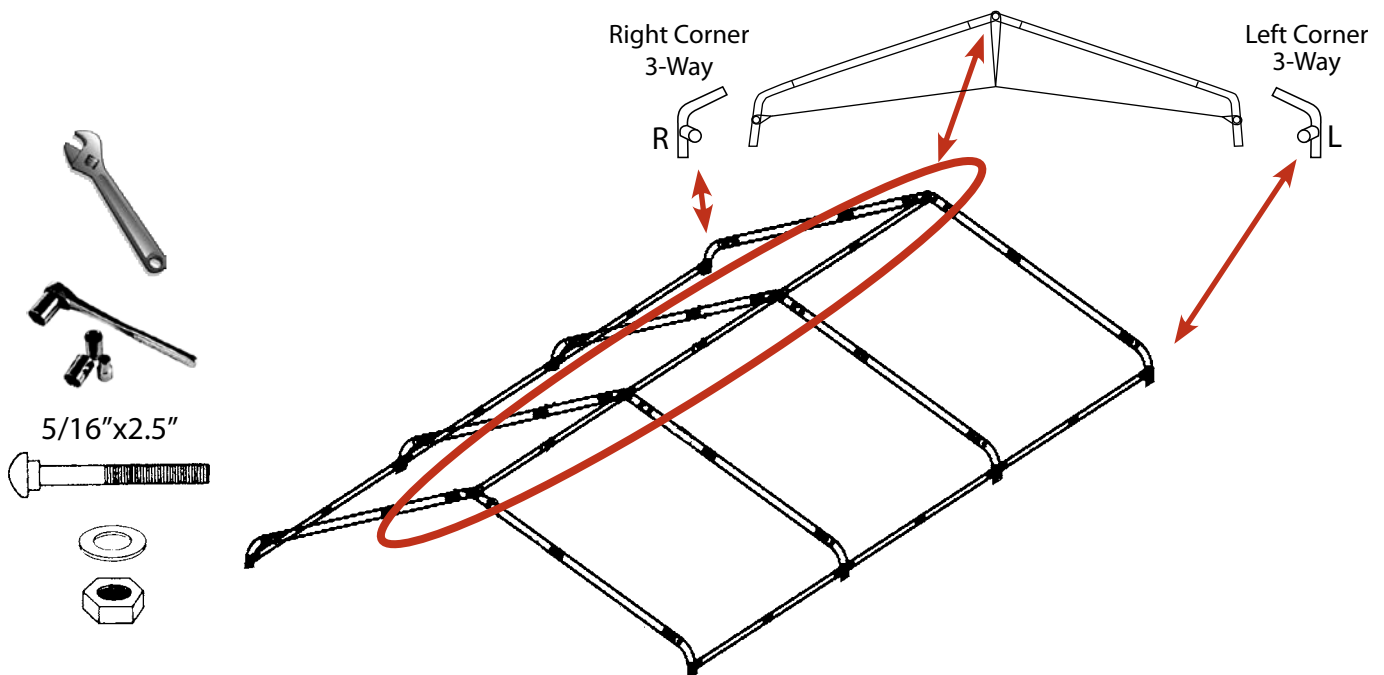



# COVER & LEGS ASSEMBLY

## Step A

Drape the cover over the the roof frame with the grommets to the bottom facing the roof frame and attach with ball bungees at each end. You may want to fold the sidewall section back onto the roof frame to keep it out of your way off the ground until you attach the legs. The sidewalls are long enough to be buried in the ground to prevent water from running inside.

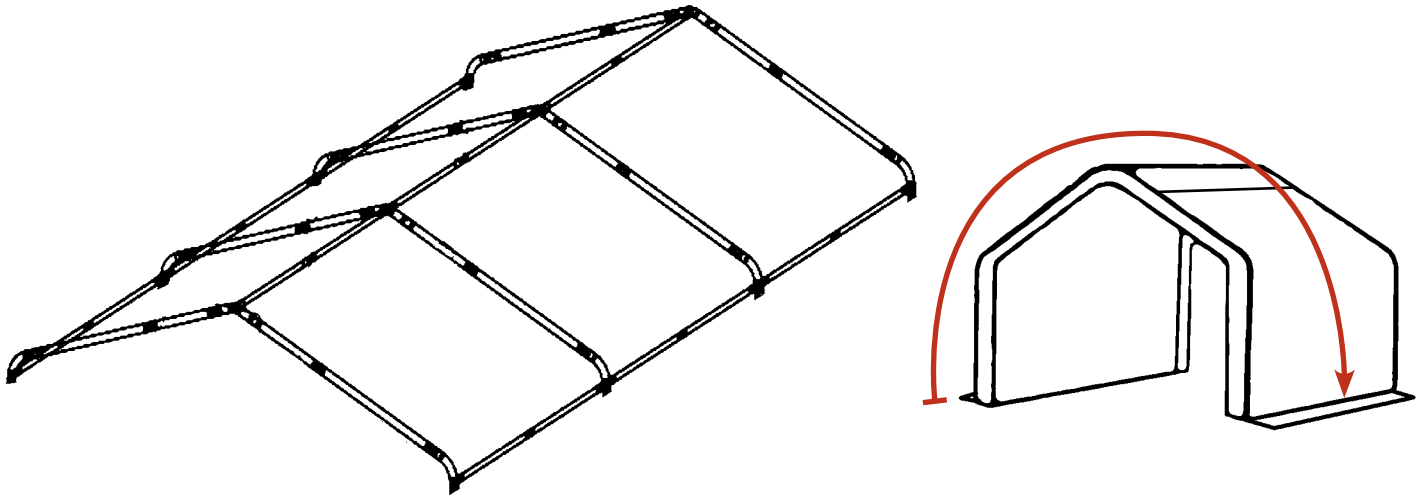

## Step B

Unfold the two zippered end walls and attach using ball bungees following the diagram below.

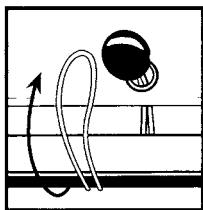
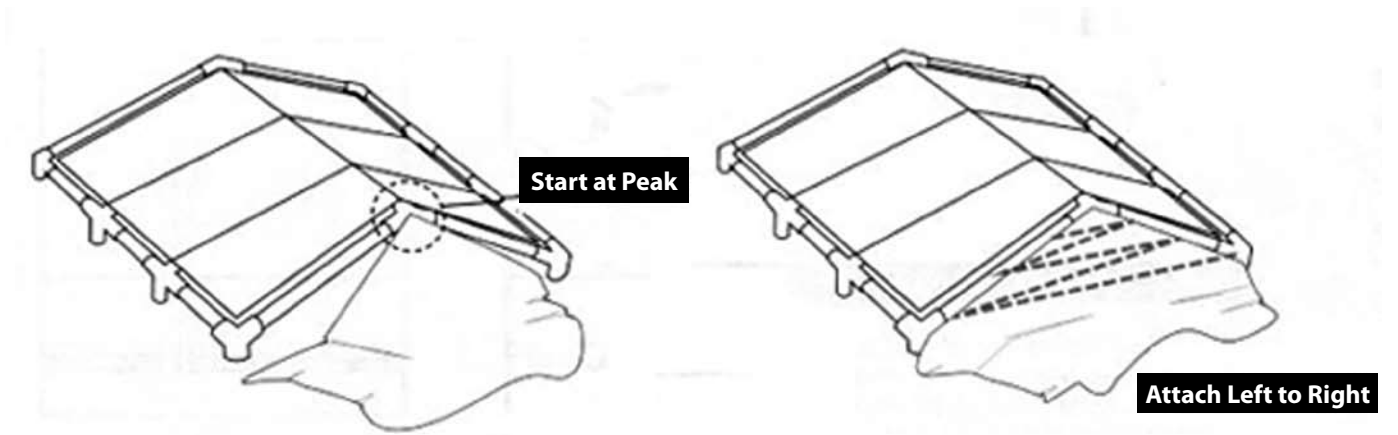

Inside View

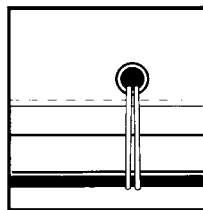

Outside View

# COVER & LEGS ASSEMBLY



## CONNECT THE LEG POLES TO THE ROOF ASSEMBLY.

### Step A

First insert the pipes (Parts A & C) for the middle poles into the 3 and 4-way connectors, and then connect the end leg pipes in the same way. Do the same for the other side. Push the foot pads onto the bottom of each leg. (See illustration)

**NOTE:** The foot pads are NOT for anchoring the canopy!

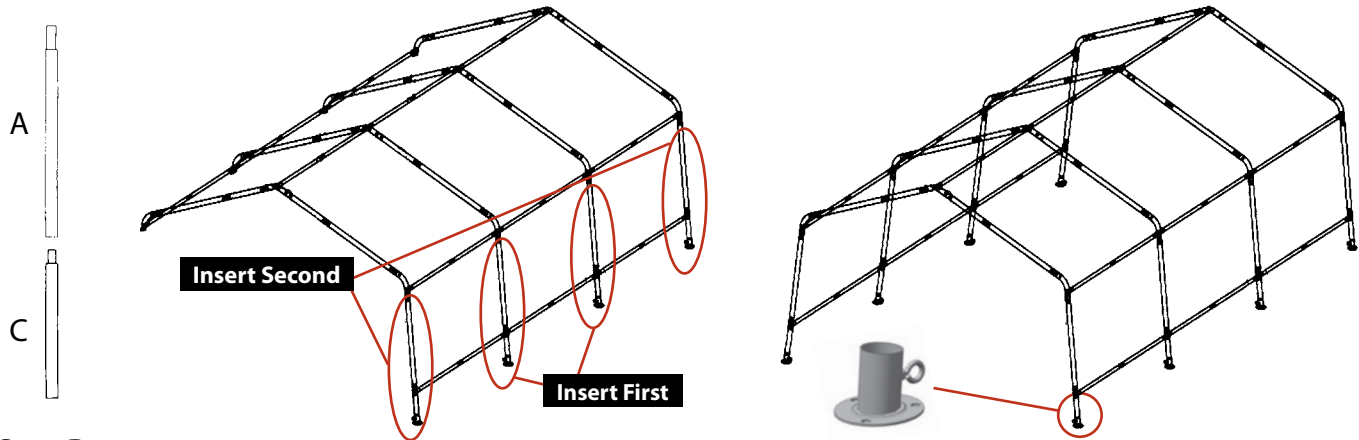

### Step B

Now slide the bottom rails through the pockets at the bottom of the sidewalls and attach using the 3 and 4-way clamps and 2" clamp bolts and nuts. Finish securing the cover by attaching the hook and loop down the ends and on top of the endwalls.

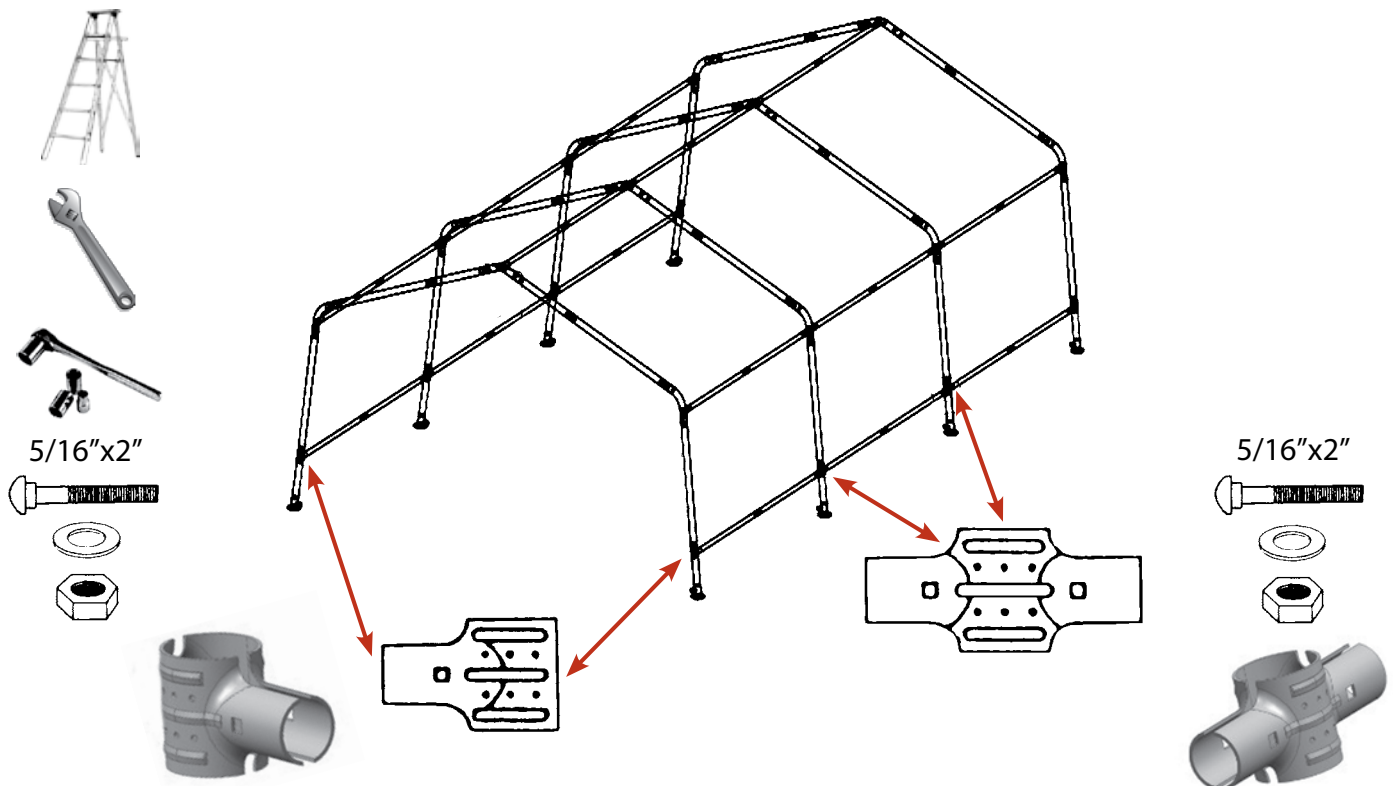

**IMPORTANT!** Once the legs and cover are assembled, your canopy will act like a kite in the wind. It is imperative that the canopy anchors be installed NOW!



# ANCHORING YOUR UNIT

This canopy is designed for use as a temporary structure. After assembly, the canopy **MUST BE** securely anchored to the ground to prevent damage from winds. Your canopy will act like a kite in the wind if not properly and securely anchored to the ground. Severe winds will cause the frame to twist and unanchored legs will fall, thereby collapsing the canopy. If severe winds are expected, you must remove the cover from the frame to prevent damage.

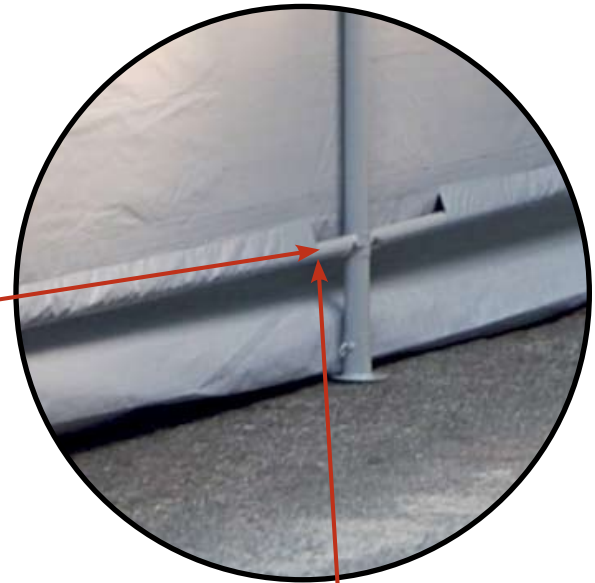

We recommend anchoring your canopy at each corner foot and center foot on each side. Screw anchor into ground next to canopy foot using a large screw driver (1). Looping the cable through the anchor eye will keep it out of the way while turning. Tilting the anchor slightly will help the anchor to cut into the ground. Apply downward pressure while turning the anchor into the ground. Leave approximately three inches of anchor out of the ground.

Unloop the cable from the anchor eye and slide the clamp onto cable (2). Run cable around the pipe, and then back through the clamp. Pull the cable as tight as possible through the clamp. Hold the cable and tighten clamp with an adjustable wrench.

When you have tightened the clamp and satisfied that the cable will not slip, you may tighten the cable more by turning the anchor further in the ground as seen in Diagram (1).

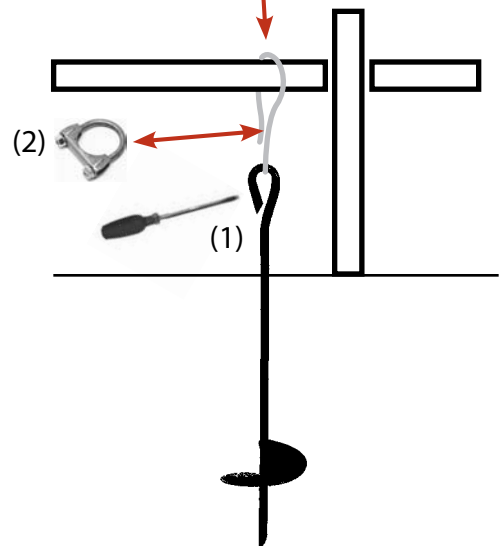

# IMPORTANT NOTICE: PLEASE READ CAREFULLY



**We are confident that you will be completely satisfied with your King Canopy unit. Please take a moment to read the very important information below, and call us with any questions you may have.**

King Canopy/PIC America, LTD. has no control over wind, snow, ice, rain or any other weather condition and we are in no way responsible for any damage caused by the canopy or to the canopy. We suggest you contact your insurance carrier just as you would for any other outside structure.

## **OTHER PRECAUTIONS WHICH MUST BE FOLLOWED:**

Keep all flame and heat sources away from this tent fabric. The tent fabric will burn if left in continuous contact with any flame source.

DO NOT cook underneath or near canopy.

DO NOT store or use flammable liquids underneath or near canopy.

DO NOT ignite or store fireworks underneath or near canopy.

DO NOT use bleach to clean cover.

DO NOT dry clean cover.

DO NOT wash cover in washing machine or dry in dryer. Hand wash with mild soap and water only.

DO NOT allow rain water, snow or ice to accumulate on top of cover.

DO NOT hang or suspend anything from the frame, grommets, truss system or ball straps of the unit.

REMOVE canopy cover before a storm, or disassemble entire canopy unit if possible.

REMOVE rain water, snow and ice from canopy cover.

**This is a temporary structure and is not recommended for use as a permanent structure.**

**The King Canopy Atlas™ Extra-Duty Garages are designed to be one of the strongest and most well designed garages in production today. This innovative product offers numerous features and benefits for the end use consumer. Key features include a commercial grade PE fabric skylight that allows sunlight to enter and “Pass-Thru” front and rear doors that make storing automobiles, boats, ATVs or personal watercraft a breeze! Our patented Woven Steel™ Cable Roof Truss System is included for increased stability and durability in extreme weather conditions and able to withstand significantly heavier loads than frame systems that do not include this outstanding feature. Easy to assemble and engineered for maximum protection. *Includes one year limited warranty. (Please see enclosed instruction sheet for details.)***

**\*\*\*The Woven Steel™ Cable System will not guarantee that your King Canopy Garage/Carport will hold heavy loads (snow specifically) indefinitely. Any significant snow accumulation must be removed frequently to avoid the possibility of PE fabric failure and steel frame collapse.\*\*\***



# PRODUCT INFORMATION

## **Defective Parts**

We try our best to eliminate any defective parts that are shipped with our products. If, however, you should find a defective part, we will replace – free of charge – any part which is defective. You will need to provide proof of purchase showing date of purchase and provide us with detailed description of the defective component. Your replacement will be shipped by ground shipping, freight prepaid. Next day or express shipping will require freight collect and paid for by you, the consumer. Damages from improper anchoring, strong winds, snow, ice or rain are not considered defects.

## **Improper Anchoring, Strong Winds, Rain Snow, or Ice**

King Canopy/PIC America, LTD. does not guarantee these canopies under strong weather conditions. These canopies are designed to protect against damages caused by sun, rain, tree sap, birds, etc. They are not designed to hold roof loads that accompany snow, ice or heavy rains. If your canopy is not anchored securely, it can be lifted by the wind and will fly away. If your canopy takes flight, we are not responsible for any replacement. If you know strong weather is predicted, remove the cover or take down the canopy unit completely. The cover is designed to be quickly and easily removed.

## **Warranty**

All components of this canopy feature a 1-year limited warranty and are warranted to be free from defects in material and workmanship for a period of 1-year. You must complete and return the enclosed warranty card promptly after purchase. Please retain your proof of purchase receipt; you will be asked to provide this receipt in order to obtain warranty service.

## **Non-Warranty Replacement Parts**

If after expiration of the warranty period, you require replacement parts please contact us at 1-800-800-6296. We stock replacement parts and make them available to you at discounted prices. Our customer service department will be pleased to assist you in any way possible.

Certain regions of the country are extremely hard on covers of any kind. Normal wear and tear is not covered under the warranty, and should be expected.

In order to receive a discounted or free replacement part, you may be asked to return the part, freight prepaid, to our warehouse for inspection before we will send a replacement. You must, in all cases, provide a copy of your receipt showing the date of purchase, model number and price.

For missing parts, replacement parts or any questions:

Please Call 8:00am – 5:00pm EST, Monday – Friday  
**1-800-800-6296 or 1-919-552-2977**

Or you can fax us at: **1-919-552-5069**

Replacement parts and customer service is also available through our website.  
Please visit us at **[www.kingcanopy.com](http://www.kingcanopy.com)**