

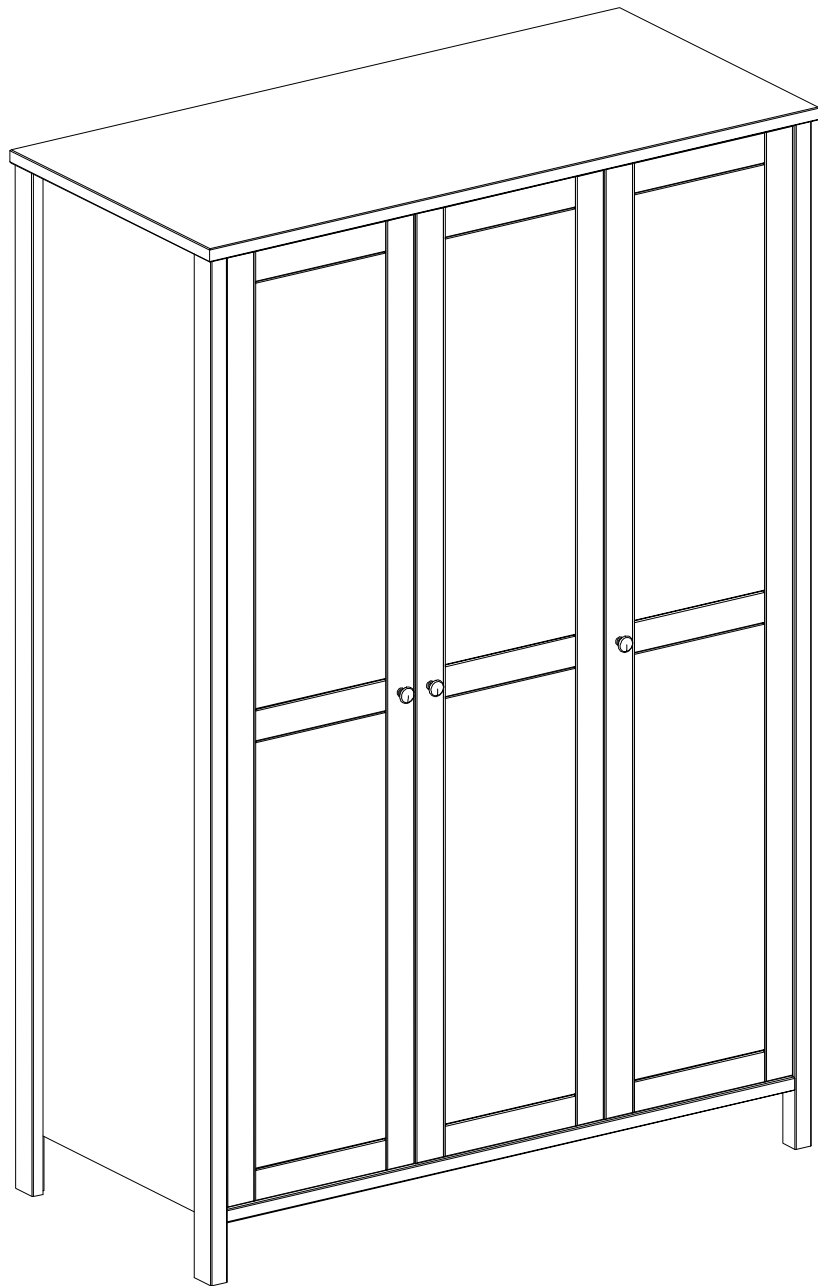

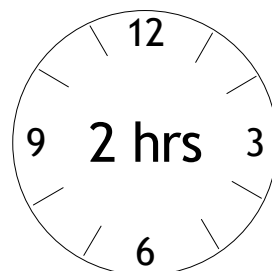

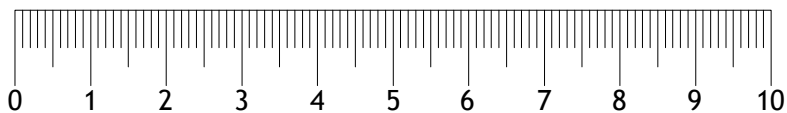

# 18530250

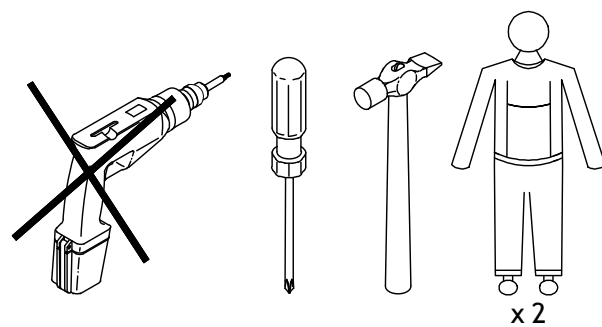
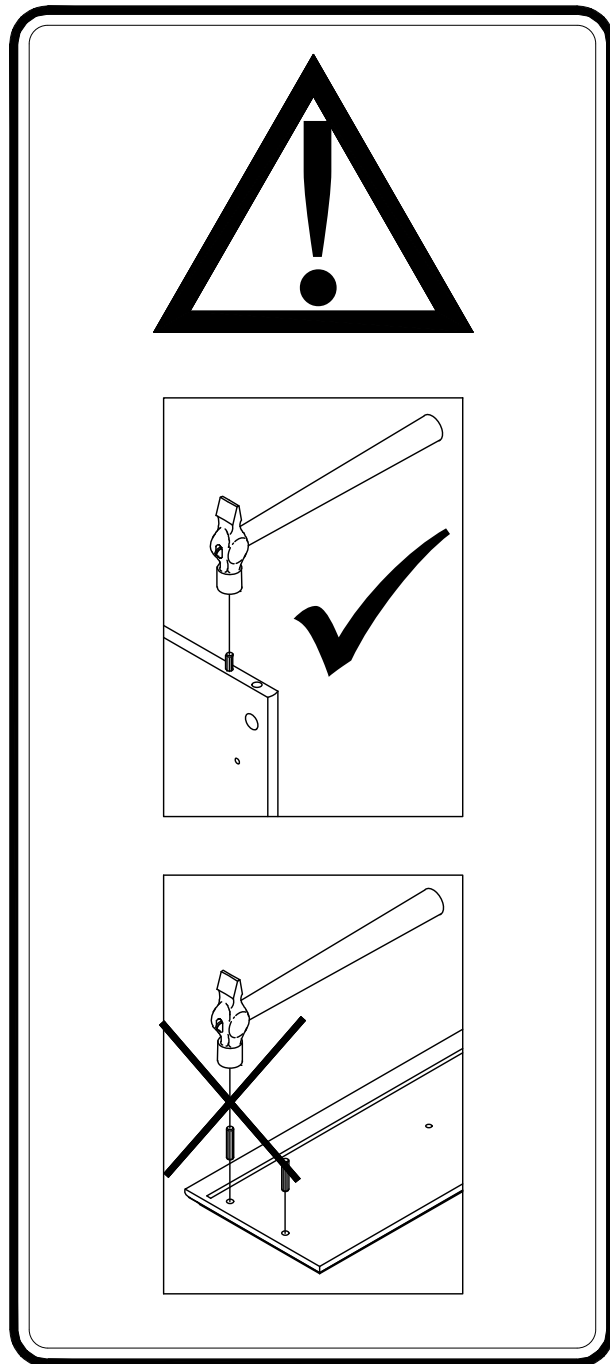
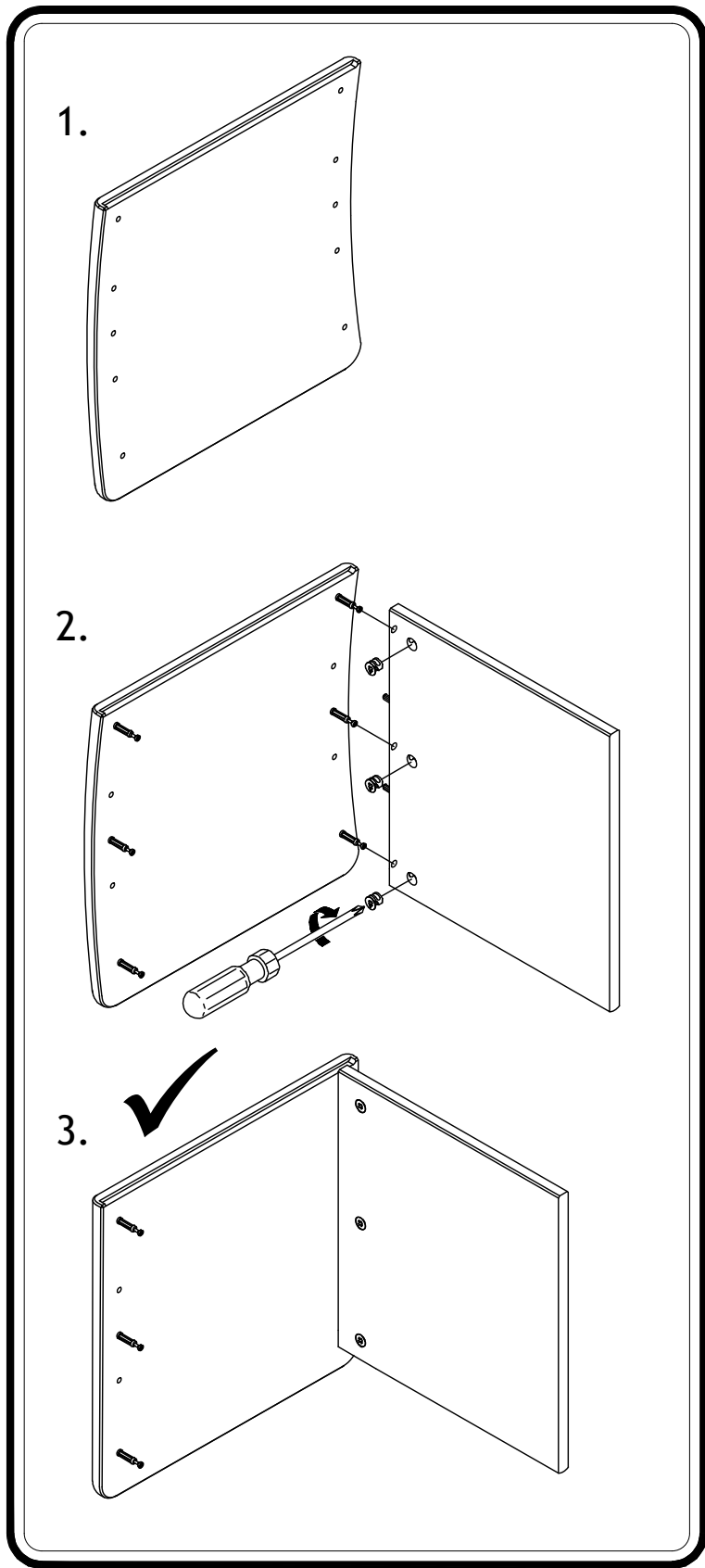
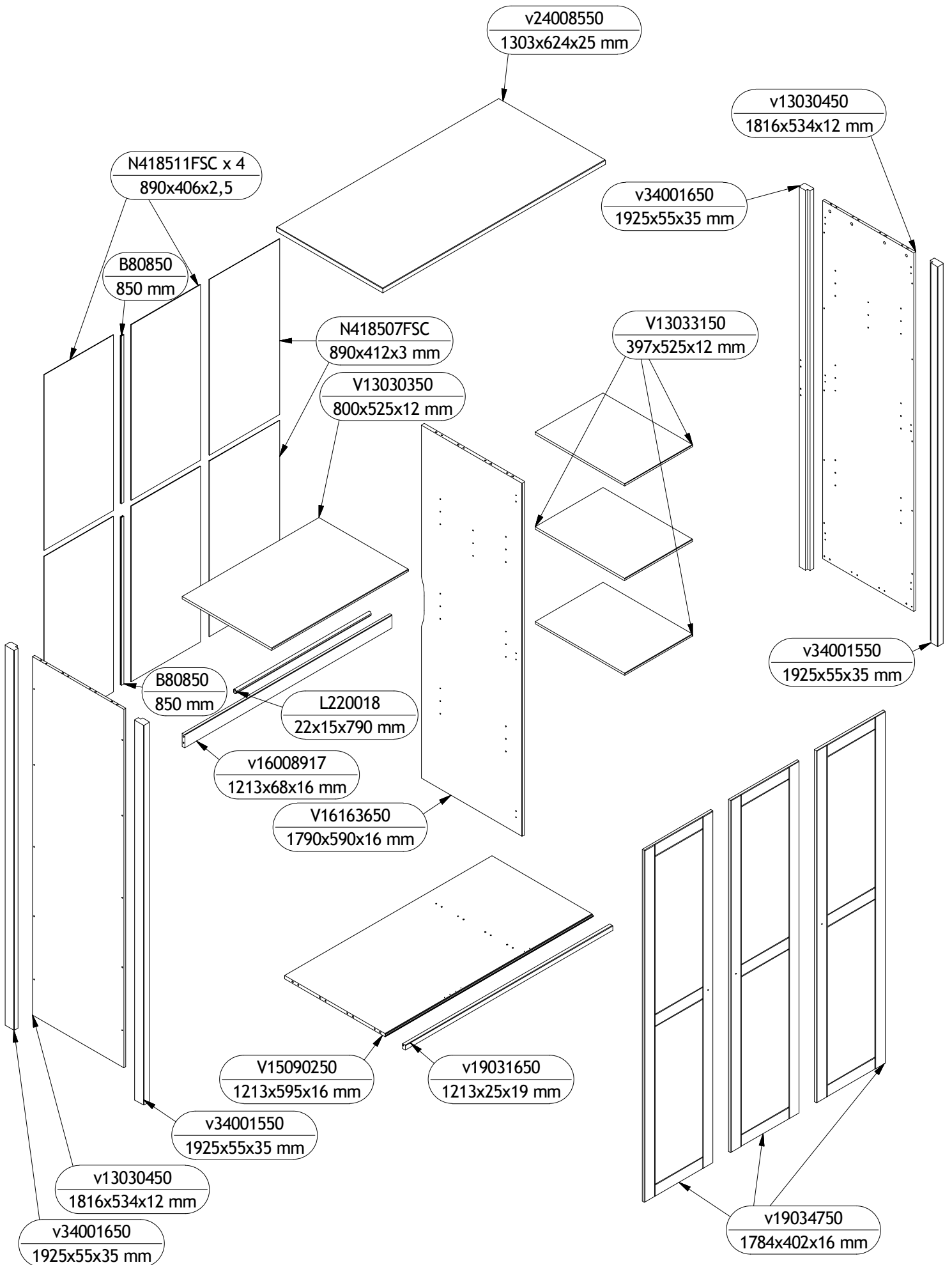
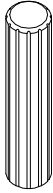
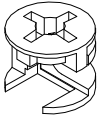
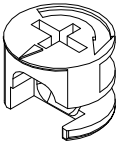
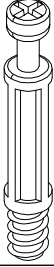



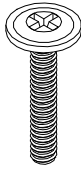
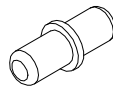
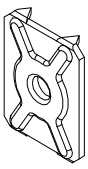
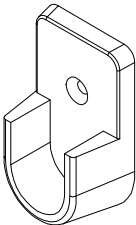
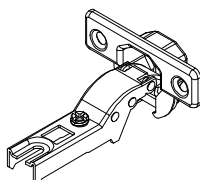
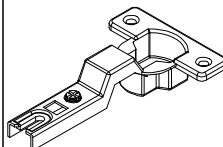
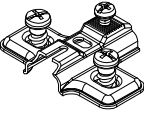
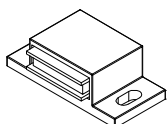
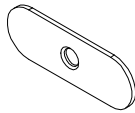
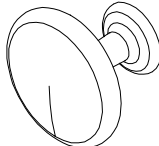
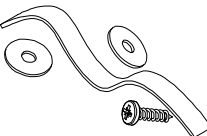

<p>BA10400x26 ø6x30 mm</p> 	<p>BA10596x8 ø12x9,5 mm</p> 	<p>BA10570x18 ø15x12 mm</p> 	<p>BA10602x26 5x34/8 mm</p> 	<p>BA10020x100 ø1,2x16 mm</p> 	<p>BA10106x8 ø3,0x12 mm</p> 
<p>BA10120x28 ø3,5x12 mm</p> 	<p>BA10112x12 ø3,5x16 mm</p> 	<p>BA10110x20 ø3,5x25 mm</p> 	<p>BA10220x3 M4x20 mm</p> 	<p>BA10830x16 5/5 mm</p> 	<p>BA10837x10 19x14xø3 mm</p> 
<p>BA10731x2 15x22 mm</p> 	<p>BA10524 x6 ø26/10,5 mm</p> 	<p>BA10508x3 ø26</p> 	<p>BA10532 x9 0 mm/37 mm</p> 	<p>BA107081x6 40x19 mm</p> 	<p>BA10709x6 35x12 mm</p> 
<p>BA10501x3 ø30x23,5 mm</p> 	<p>BA182002x1</p> 	<p>I10881x1 15 g</p> 