

MONTE CARLO

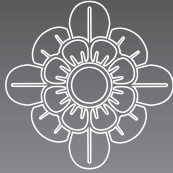

CEILING FAN COMPANY

Owner's Guide and Installation Manual

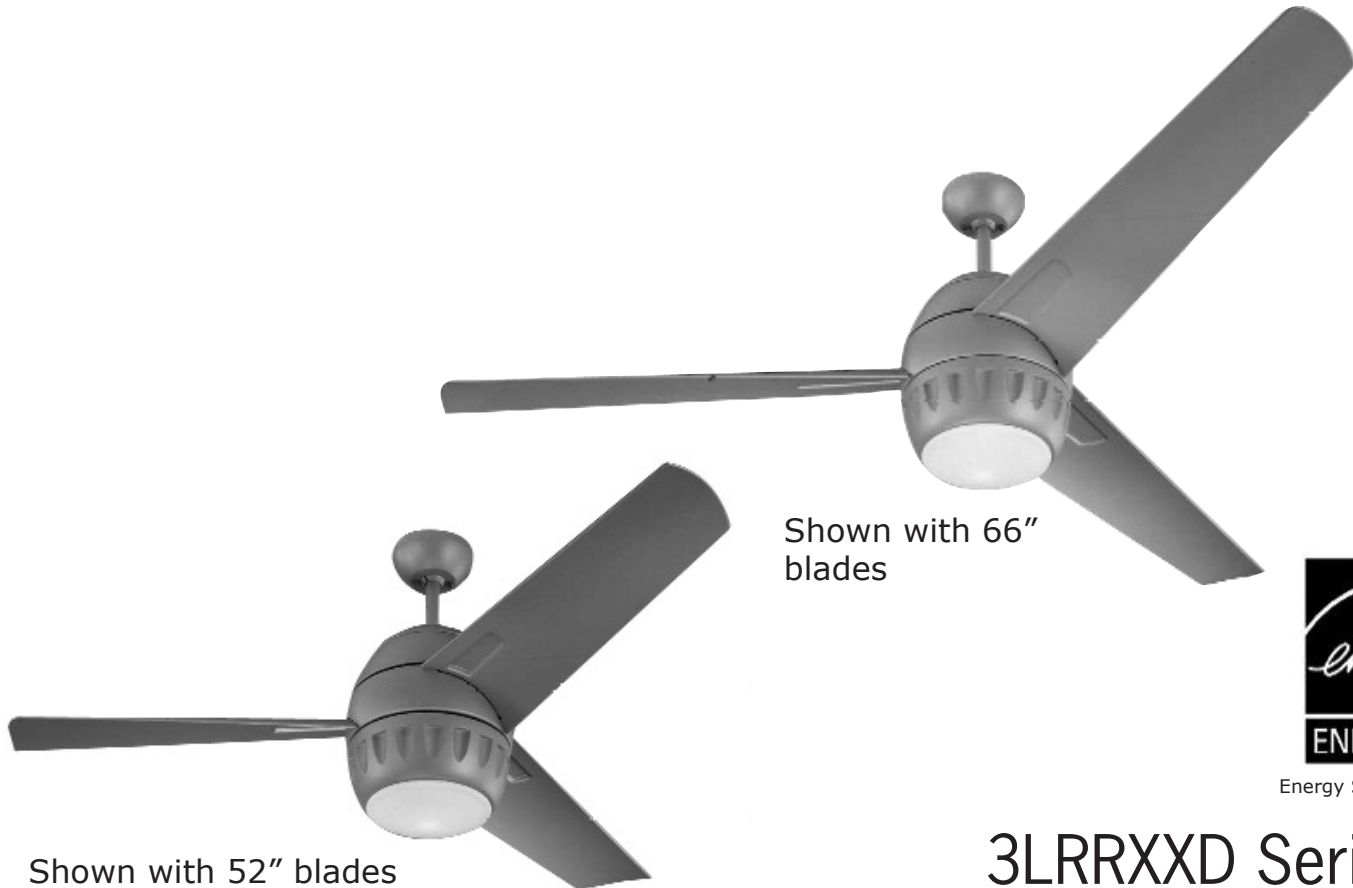

Shown with 66" blades

Shown with 52" blades



Energy Star approved with 52" blades

3LRRXXD Series Fan

UL Model No. : 3LRR66/52

Attach sales receipt to this card and retain as your proof of purchase

DATE OF PURCHASE: _____

RETAILER NAME: _____

MODEL NUMBER: _____

RETAILER ADDRESS: _____

To register your fixture, please visit our website www.montecarlofans.com



10.6 kgs
23.4 lbs

Total fan weight with light kit



Cautions and Warnings

WARNING: TO REDUCE THE RISK OF FIRE, ELECTRIC SHOCK, OR INJURY TO PERSONS, OBSERVE THE FOLLOWING READ AND SAVE THESE INSTRUCTIONS

Installation work and electrical wiring must be done by qualified person(s) in accordance with applicable codes and standards (ANSI/NFPA 70-1999), including fire-rated construction.

Use this unit only in the manner intended by the manufacturer. If you have any questions contact the manufacturer.

After making the wire connections, the wires should be spread apart with the grounded conductor and the equipment-grounding conductor on one side of the outlet box and ungrounded conductor on the other side of the outlet box. The splices, after being made, should be turned upward and pushed carefully up into the outlet box.

WARNING: Before you begin installing the fan, servicing or cleaning unit, Switch power off at Service panel and lock service disconnecting means to prevent power from being switched on accidentally. When the service disconnecting means cannot be locked, securely fasten a prominent warning device, such as a tag, to the service panel.

Be cautious! Read all instructions and safety information before installing your new fan. Review the accompanying assembly diagrams.

When cutting or drilling into wall or ceiling, do not damage electrical wiring and other hidden utilities.

Make sure the installation site you choose allows the fan blades to rotate without any obstructions. Allow a minimum clearance of 7 feet from the floor to the trailing edge of the blade.

WARNING: To Reduce The Risk Of Fire, Electric Shock, or Personal Injury, Mount To Outlet Box Marked "Acceptable for Fan Support of 15.9 kg (35 lbs) or less" And Use Mounting Screws Provided With The Outlet Box.

WARNING: To reduce the risk of personal injury, do not bend blade holders during installation to motor, balancing or during cleaning. Do not insert foreign object between rotating blades.

Attach the mounting bracket using only the hardware supplied with the outlet box.

WARNING: To reduce the risk of fire or electric shock, this fan must be installed with an isolating wall control/switch.

WARNING: To reduce the risk of fire or electric shock, this fan should only be used with fan speed control part no. UC7067RYK manufactured by Rhine Electronic Co., Ltd.

WARNING: To reduce the risk of fire or electric shock, do not use this fan with any solid state fan speed control device, or variable speed control.

If this unit is to be installed over a tub or shower, it must be marked as appropriate for the application.

Never place a switch where it can be reached from a tub or shower.

The combustion airflow needed for safe operation of fuel-burning equipment may be affected by this unit's operation. Follow the heating equipment manufacturer's guideline safety standards such as those published by the National Fire Protection Association (NFPA), and the American Society for Heating, Refrigeration and Air Conditioning Engineers (ASHRAE) and the local code authorities.

CAUTION: To Reduce the Risk of Electric Shock, Disconnect the electrical supply circuit to the fan before installing the light kit.

All set screws must be checked and tightened where necessary before installation.

Tools Required for Assembly (not included): Electrical Tape, Phillips Screwdriver, Pliers, Safety Glasses, Stepladder and Wire Strippers.

Customer Service
800-969-3347

Customer Service Center
7400 Linder Ave.
Skokie, IL 60077
www.montecarlofans.com

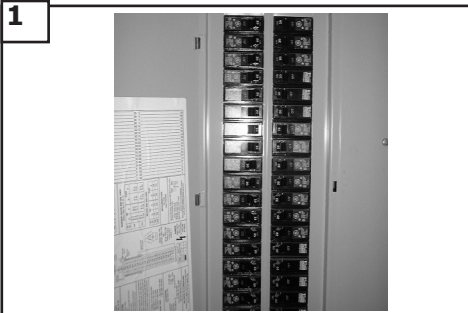

1 Before you begin installing the fan, Switch power off at Service panel and lock service disconnecting means to prevent power from being switched on accidentally. When the service disconnecting means cannot be locked, securely fasten a prominent warning device, such as a tag, to the service panel.

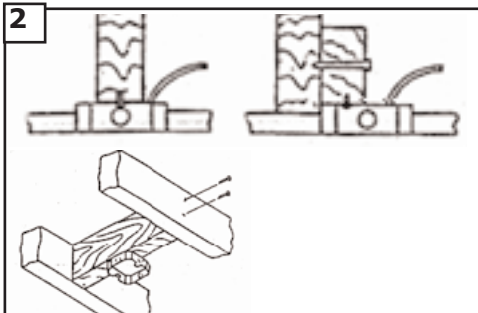

2 Before installing this fan make sure the outlet box is properly installed to the house structure. To reduce the risk of fire, electric shock, or personal injury, mount to outlet box or supporting system acceptable for fan support. (Mounting must support at least 35 lbs.)



3 Use metal outlet box suitable for fan support and **use only the screws provided with the outlet box** (must support 35 lbs). Before attaching fan to outlet box, ensure the outlet box is securely fastened by at least two points to a structural ceiling member (a loose box will cause the fan to wobble). Remove the two outlet box screws provided with the box, aligning the holes of the mounting bracket with the holes of the outlet box. Re-install the 2 outlet box screws securely.

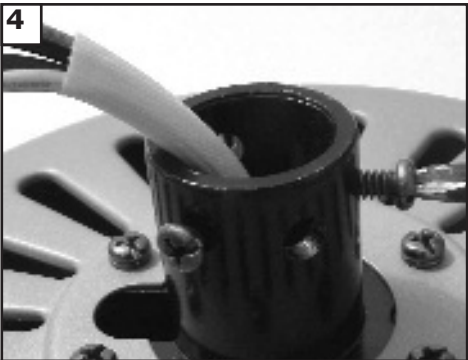

4 Loosen the 2 set screws until the do not protude into the inside of the yoke.

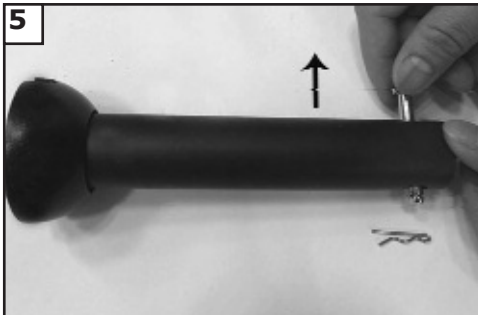

5 Remove cotter pin from downrod, and save for later use.

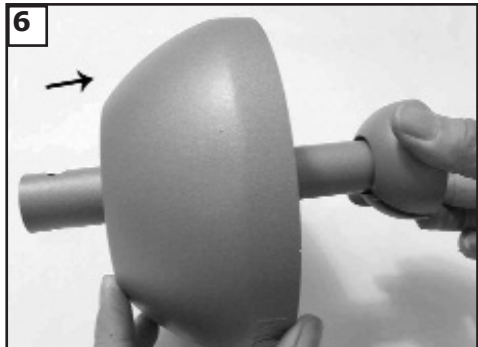

6 Place canopy over downrod.

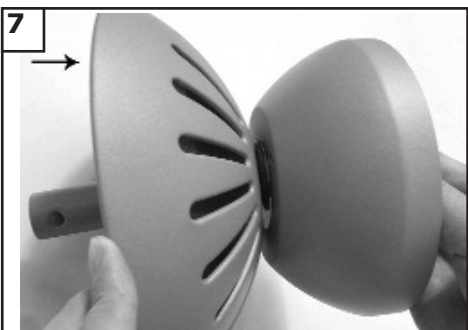

7 Place yoke cover over downrod.

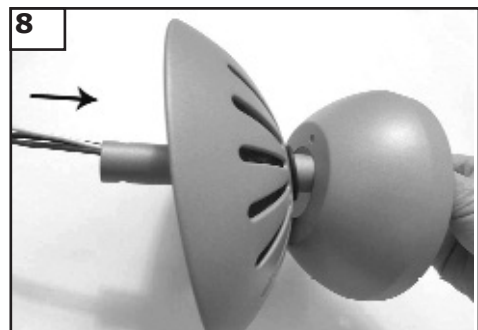

8 Thread the leadwires and safety cable through the downrod.

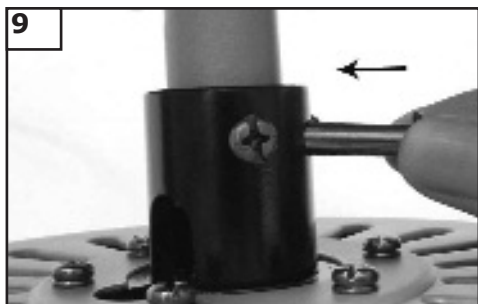

9 Insert downrod into the yoke on top of fan body. Align the hole in the downrod with the hole in the yoke. Insert cotter pin through yoke and downrod until point appears on the other side



10

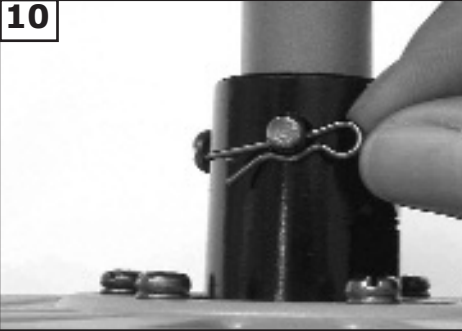

Install keeper pin.

11



Tighten the 2 set screws on the yoke, once the down rod is in place.

12



Make sure the studs protruding from the bottom of the Mounting bracket are installed with threads all the way through the bracket.

13



Hang assembled fan from the mounting bracket installed to ceiling in previous step. Make sure the fan is hanging straight. Rotate fan until the tab on the Mounting bracket engages the slot on the Downrod Ball. This must be done to prevent the fan body from rotating when the blades are in motion.

14

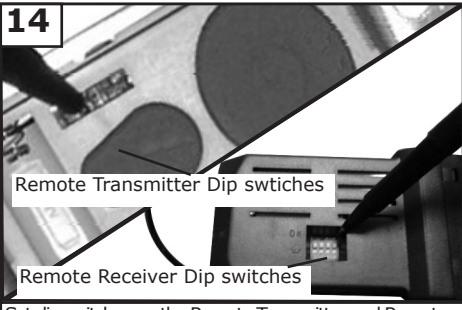

Set dip switches on the Remote Transmitter and Remote Receiver to the same settings. This must be done so the units will communicate properly. If you have other fans you can set to control from one transmitter by setting both receivers the same as the transmitter. If you have more than one fan with remote. You can set the dip switches to different positions to have separate control.

15

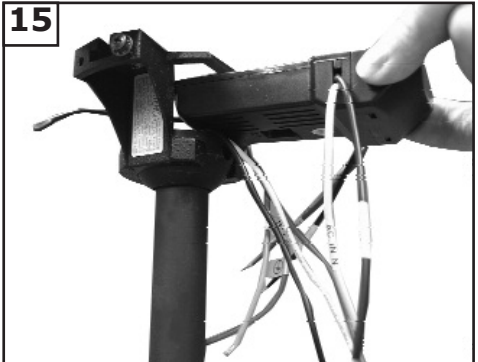

Install remote receiver into the mounting bracket.

16

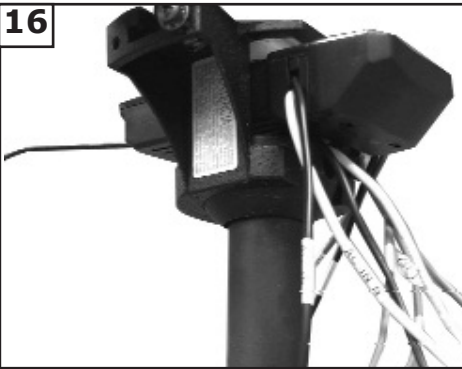

Ready for wiring.

17

Safety cable installation



For Canadian installation and for USA fan and light kit combinations over 35 lbs, in both flush and downrod mode the safety cable must be installed into the house structure beams using the 3" lag screws, washers, and lock washers provided. Make sure that when the safety cable is fully extended the leadwires are longer than the cable and no stress is placed on the leadwires.

18

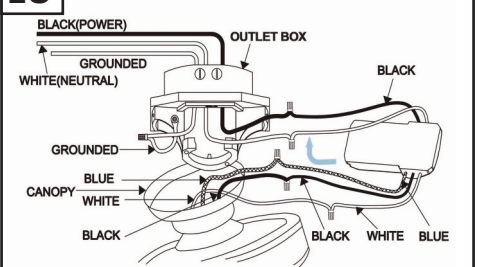

Make wiring connections as indicated above. White from fan to white from remote marked N. Blue from fan to blue from remote marked light. Black from fan to Black from remote marked L. White from house to white from remote marked AC N. Black from house to Black from remote marked AC L. Connect all green ground wires to Grounded wire from House.



19
Make wire connections to power source using wire nuts provided. Make sure that no filaments are outside of the wirenut. After making the wire connections, the wires should be spread apart with the grounded conductor and the equipment-grounding conductor on one side of the outlet box and ungrounded conductor on the other side of the outlet box. The splices, after being made, should be turned upward and pushed carefully up into the outlet box.



20
Lift canopy and install knurled nuts as shown. Tighten the knurled nuts securely. The canopy should adjust for any irregularity in the ceiling or Outlet box.

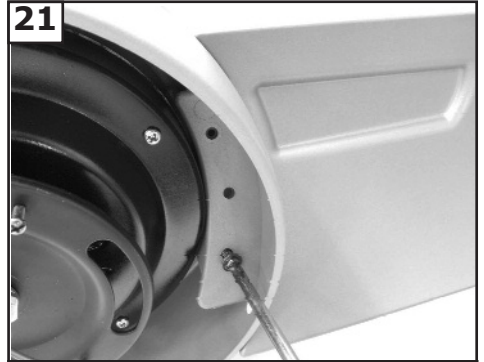

21
Check for shipping stabilizers and remove if present. Attach blades using screws in hardware pack. **Blades sold separately.** Tighten screws securely. Repeat 2 more times.



22
Loosen 2 screws are remove one screw. Keep removed screw for later use.

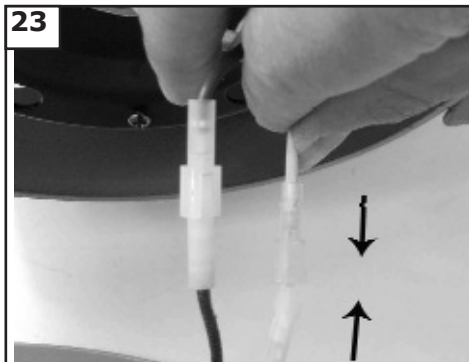

23
Connect white wire from fan to White wire from light fixture. Connect blue wire from fan to Black wire from light fixture.

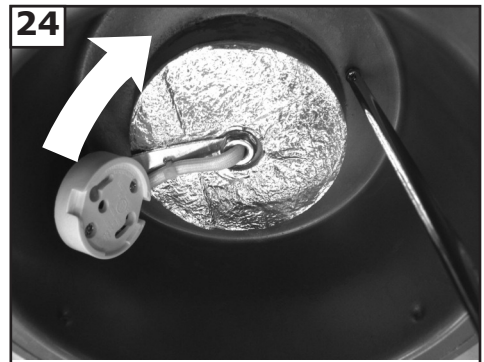

24
Align keyslot holes of light kit plate and twist to lock clockwise. Install screw removed in step 22 and tighten all screws securely.

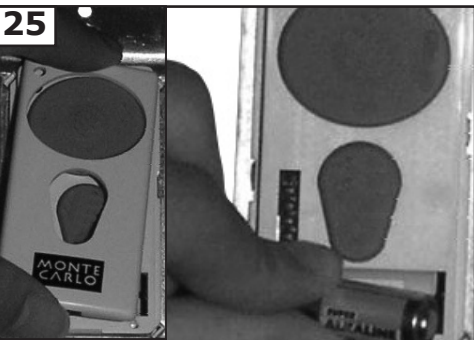

25
Remove battery cover. Install 12V battery into wall remote. Duracell MN21 / Eveready A23 / GP 23A all 12V. Attach cover of remote by placing over buttons and snap the battery cover in place.

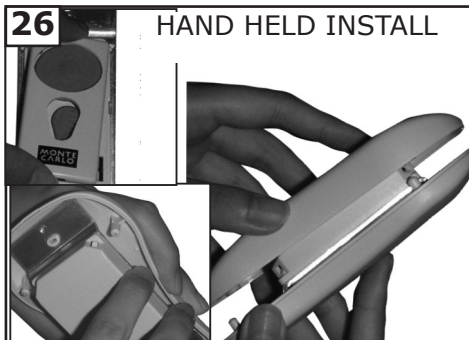

26 HAND HELD INSTALL
Place face plate over battery compartment and buttons. Place remote over 2 pins on front cover. Attach cover of remote by placing over 4 pins and snapping into place.

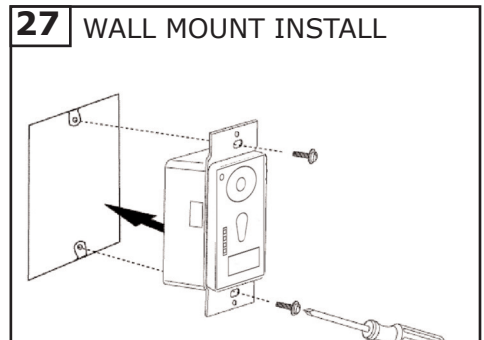

27 WALL MOUNT INSTALL
Install wall control unit to outlet box using machine screws provided.



28

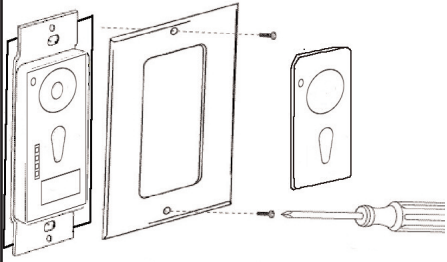

Attach front cover to wall control with screws provided. Snap battery cover in place.

For fan without bulb, go to step 29.

For fan with bulb, go to step 30

29

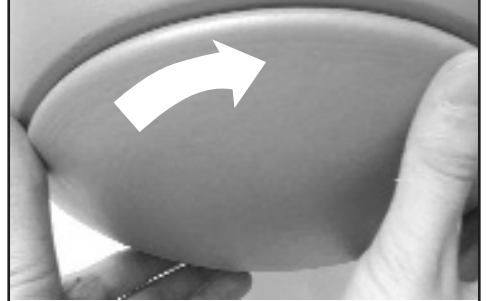

Attach blanking plate by locating dimples in light fixture with grooves in the blanking plate and twist clockwise.

30



Attach the GU24 18W CFL bulb and secure by twisting clockwise. Bulb included.

WARNING: USE MAXIMUM GU24 18 WATTS LISTED SBCFL (SELF-BALLASTED COMPACT FLUORESCENT LAMP) ONLY, NOT USING SBCFL WILL OVERHEAT THE UNIT AND CAUSE DAMAGE TO THE UNIT OR THE FAN WHICH THE UNIT IS INSTALLED TOGETHER.

31

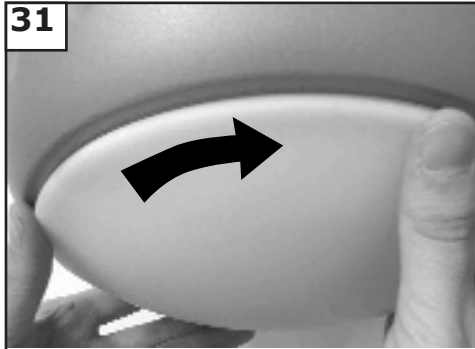

Attach the glass by locating dimples in light fixture with grooves in the glass and twist clockwise until tight.



Remote Control Transmitter Features:

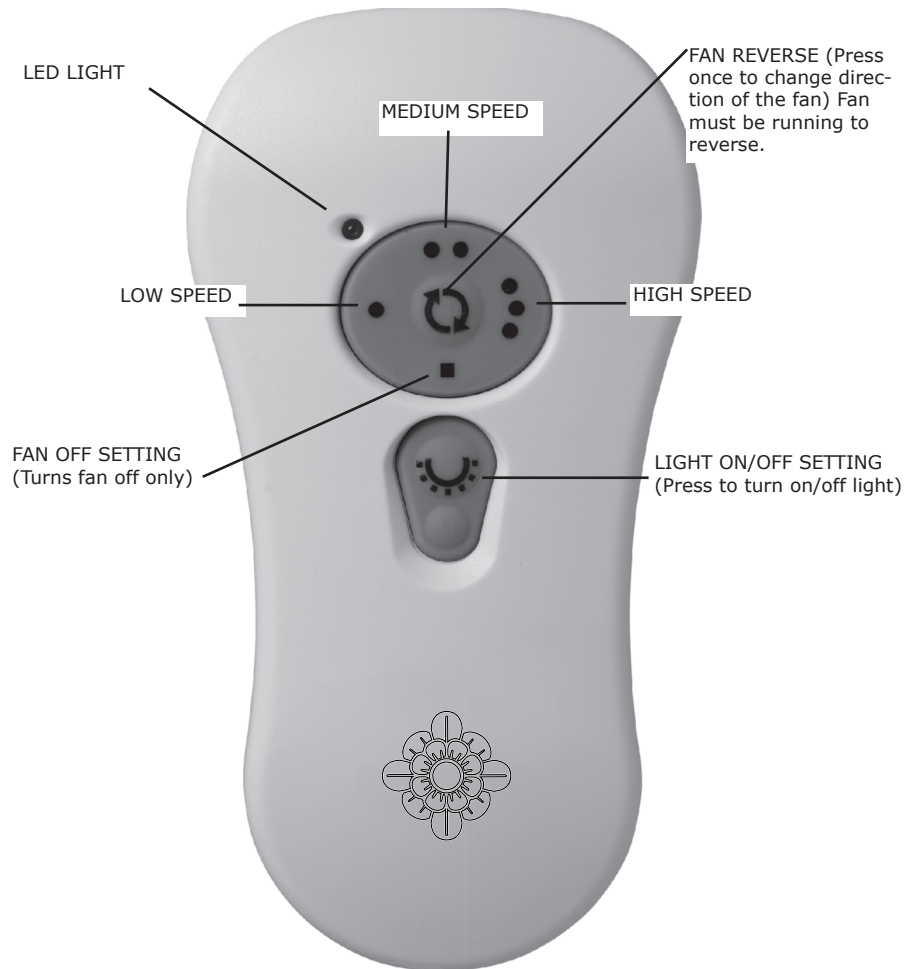

FAN SPEED Depress "1 dot" for low speed, "2 dots" for medium or "3 dots" for high. To turn fan off press square".

LIGHT ON/OFF To turn light on, press light button once quickly. To turn off press once quickly while light is on.

FORWARD/REVERSE Depress rev button allow a few seconds for remote to change rotation direction with fan running.

WARNING: This fixture is not dimmable. Use only with on/off switch. Do not use in conjunction fan/light remote controls or light dimmers.



TROUBLE SHOOTING

If you have difficulty operating your new ceiling fan, it may be the result of incorrect assembly, installation, or wiring. In some cases, these installation errors may be mistaken for defects. If you experience any faults, please check this Trouble Shooting Chart. If a problem cannot be remedied, or you are experiencing difficulty in installation, please call our Customer Service Center at the number printed on your parts list insert sheet.

Warning: Before servicing or cleaning unit, Switch power off at Service panel and lock service disconnecting means to prevent power from being switched on accidentally. When the service disconnecting means cannot be locked, securely fasten a prominent warning device, such as a tag, to the service panel.

1. If fan does not start:
 1. Check main and branch circuit fuses or circuit breakers.
 2. Check line wire connections to fan and switch wire connections in switch housing.
CAUTION: Make sure main power is turned off.
 3. Make sure forward/reverse switch is firmly in up or down position. Fan will not operate when switch is in the middle.

2. If fan sounds noisy:
 1. Check to make sure all screws in motor housing are snug (not over tightened).
 2. Check to make sure the screws which attach the fan blade holder to the motor are tight.
 3. Check to make sure wire nut connectors in switch housing are not rattling against each other or against the interior wall of the switch housing.
CAUTION: Make sure main power is turned off before entering switch housing.
 4. Some fan motors are sensitive to signals from Solid State variable speed controls.
 5. Allow "break-in" period of 24 hours. Most noises associated with a new fan will disappear after this period.

3. If fan wobbles:
 1. Make sure that the ridge of the canopy engages the notch in the downrod ball.
 2. Check that all blades are screwed firmly into blade holders.
 3. Check that all blade holders are tightened securely to motor.
 4. Make sure that canopy and mounting bracket are tightened securely to ceiling junction box and junction box is mounted firmly to ceiling joist.
 5. Most fan wobble problems are caused when blade levels are unequal. Check this level by selecting a point on the ceiling above the tip of one of the blades. Measure this distance from blade tip to ceiling. Keeping measure within 1/8", rotate the fan until the next blade is positioned for measurement. Repeat for each blade. If all blade levels are not equal, you can adjust blade levels by the following procedure. To adjust a blade tip down, insert a washer (not supplied) between the blade and blade holder at the screw closest to the motor. To adjust a blade tip up, insert washer (not supplied) between the blade and blade holder at the two screws farthest from the motor. Reverse the position of the washer if blades mount from top of blade.
 6. If blade wobble is still noticeable, interchanging two adjacent (side by side) blades can redistribute the weight and possibly result in smoother operation.

4. If light does not work:
 1. Check blue wire from fan to make sure it is connected to hot wire from house.
 2. Check for loose or disconnected wires in fan switch housing.
 3. Check for loose or disconnected wires in light kit.
 4. Check for faulty light bulbs.

WARNING: USE MAXIMUM GU24 18 WATTS LISTED SBCFL (SELF-BALLASTED COMPACT FLUORESCENT LAMP) ONLY, NOT USING SBCFL WILL OVERHEAT THE UNIT AND CAUSE DAMAGE TO THE UNIT OR THE FAN WHICH THE UNIT IS INSTALLED TOGETHER.

CAUTION: Make sure main power is turned off before entering switch housing and/or canopy.

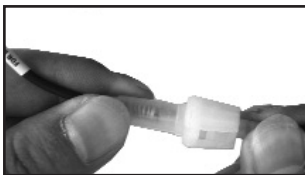

User Servicing Instructions

WARNING: Before attempting to replace the fuse make sure the main power is turned off to the fan. (Fuse is inside the canopy on the blue wire to remote receiver, push and twist the cap to open the fuse case) Push and twist to reassemble fuse. Risk of fire. Replace fuse only with 3 amp, 125 volt fuse.

Jan.27.10 revise - Add ES logo, ES approved with 52" blades

Feb.2012 New format