



ROWING MACHINE

SF-RW1205



For Customer Service, please contact:
support@sunnyhealthfitness.com

ROWING MACHINE

Important Safety Information

We thank you for choosing our product. To guarantee your safety and health, please use this equipment correctly. Please read the information below carefully before using this equipment.

1. It is important to read this entire manual before assembling and using the equipment. Safe and effective use can only be achieved if the equipment is assembled, maintained and used properly.
2. Before starting any exercise program you should consult your doctor to determine if you have any medical or physical conditions that could put your health and safety at risk, or prevent you from using the equipment properly. Your doctor's advice is essential if you are taking medication that affects your heart rate, blood pressure or cholesterol level.
3. Be aware of your body's signals. Incorrect or excessive exercise can damage your health. Stop exercising if you experience any of the following symptoms: pain, tightness in your chest, irregular heartbeat, and extreme shortness of breath, lightheadedness, dizziness or feelings of nausea. If you do experience any of these conditions you should consult your doctor before continuing with your exercise program.
4. Keep children and pets away from the equipment. The equipment is designed for adult use only.
5. Use the equipment on a solid, flat level surface with a protective cover for your floor or carpet. To ensure safety, the equipment should have at least 1.7 feet of free space all around it.
6. Before using the equipment, check that the nuts and bolts are securely tightened. Always use the equipment as indicated. If you find any defective components while assembling or checking the equipment, or if you hear any unusual noises coming from the equipment during use, stop immediately. Do not use the equipment until the problem has been rectified.
7. There are many functions of the computer; the data will show when using the equipment and will display information about your exercise routine.
8. Wear suitable clothing while using the equipment. Avoid wearing loose clothing that may get caught in the equipment or that may restrict or prevent movement.
9. This equipment is designed for indoor and home use only, not intended for commercial use.
10. Care must be taken when lifting or moving the equipment so as not to injure your back.
11. The equipment is not suitable for therapeutic use.
12. Please save this manual and the assembling tools as well.
13. Maximum weight of user: 220LB.

ROWING MACHINE

PARTS LIST

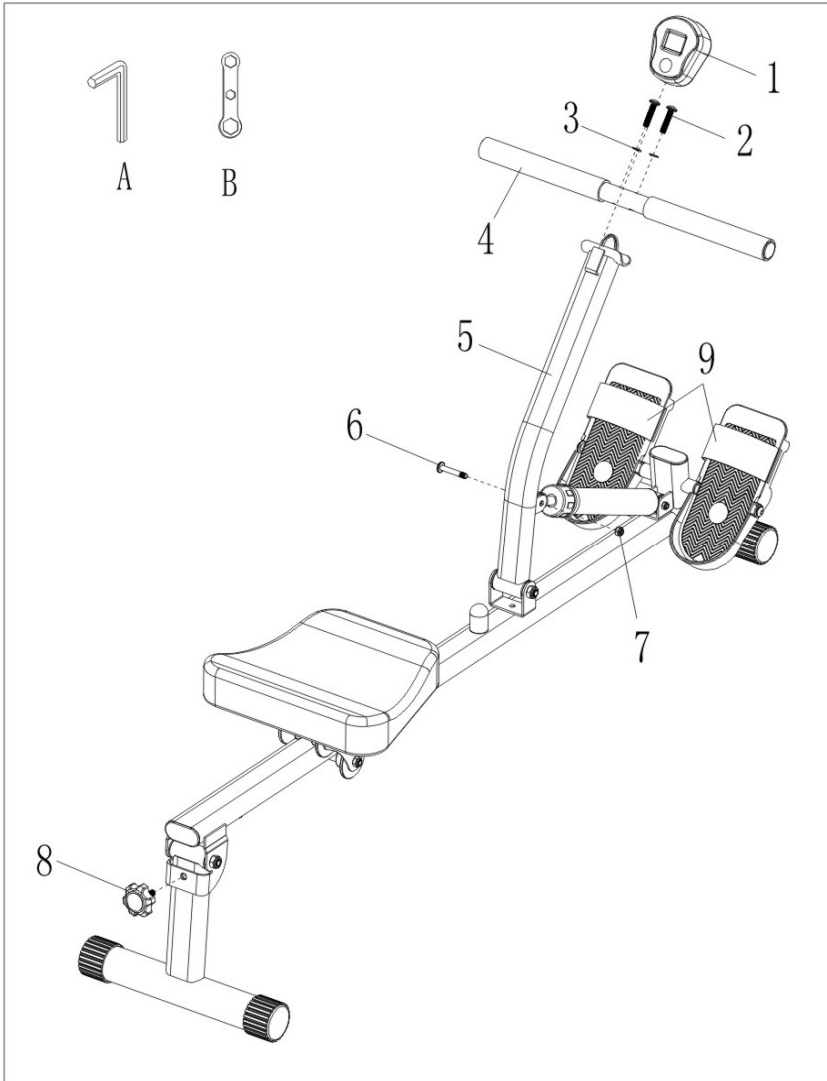

NO	Parts	QTY
1		1
2		2
3		2
4		1
5		1
6		1
7		1
8		1
9		2
A		1
B		1

ROWING MACHINE

ASSEMBLY INSTRUCTIONS



Verify you have these components.

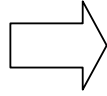

Take out the adjust knob (#8) and open the Rear Support Tube. Then, secure the adjust knob (#8).

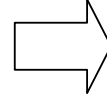

Take out the screw (#6) and nut (#7). Use the allen key (#A) and allen wrench (#B) to secure the cylinder with screw (#6) and nut (#7).

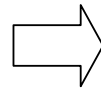
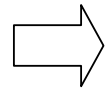

Use the allen key (#A) to loosen the screws, and washers (#2,3).



Use the allen key (#A) to secure the the handle bar (#4) using the screws and washers (#2,3).

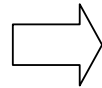

Attach the meter (#1) on the handle bar and connect to the meter wire.

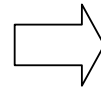

Slide the foot strap (#9) through both slits under the pedal. Make sure the fluff side is facing upward.



Slide one side through the hoop.

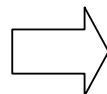

Stick the foot strap (#9) together.

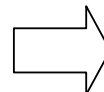

Assembly completed!

ROWING MACHINE

WARNING: Consult a physician before using this equipment.

SAFETY INSTRUCTIONS:

1. Do not allow children to use or play on this equipment. Keep children and pets away from this equipment when it is in use.
2. Set up and use this equipment on a solid level surface. Do not use it on loose rugs or uneven surfaces.
3. Consult your personal physician before using this equipment, especially if you are pregnant, or suffer from any illness. Stop and consult your physician, if you feel faint, dizzy, or any pain during exercise.
4. Before using the machine, always do stretching exercises to properly warm up.
5. Never operate the machine if it is not functioning properly.
6. Ensure that all nuts and bolts are tightened properly before each use.
7. The time limit of exercise is 10-15 minutes each time.
8. The ROWING MACHINE is designed for HOME USE only, it is not for commercial use.
9. Persons weighing over 220LB should not use this equipment.

EXERCISE INSTRUCTIONS:

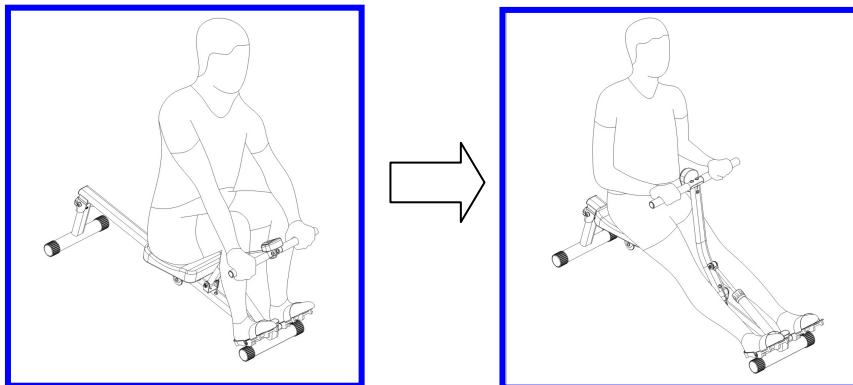

Step 1. Step on the pedals and hold the handle bar.

Step 2. Pull the handle bar towards you as you push your legs out.

If you want to adjust the level of tension, please turn the adjustment knob of the cylinder carefully as seen below. Level 1 is the lowest level. (The tension increases from level 1 to level 12)



ROWING MACHINE

FUNCTION OF METER

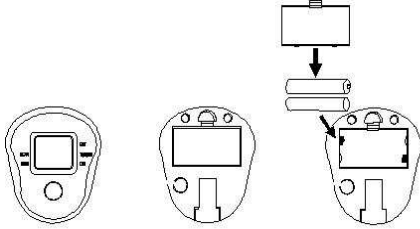
SCAN	Press "mode" key to select "scan", this will automatically scan through all the functions displayed on the bottom line of the monitor.
TIME	Automatically accumulates workout time when starting exercise.
COUNT	Automatically accumulates workout counts when starting exercise.
TOTAL COUNT	Automatically accumulates different sessions workout counts when starting exercise.
CALS	Automatically accumulates the amount of calories consumed when starting exercise.
Function Button	<p>Press and release to select functions. Press and hold four seconds to reset TIME、CNT、CAL to zero.</p> 
BATTERY	The meter operates with two 1.5v AA batteries. Replace the battery if you see an improper display on the monitor.

OPERATION PROCEDURES

AUTO ON/OFF :

The monitor will be automatically shut off if there is no signal coming in for 4 to 5 minutes.

The monitor will be auto-powered when you start to exercise, push button or signal in.