

PORTBROOK™

FP7948**

Desktop/Wall Oscillating Fan

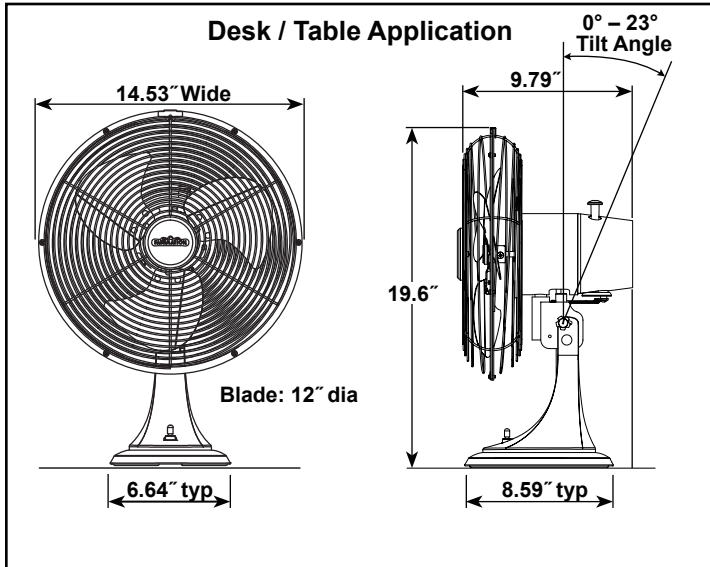

Available Finishes	
OB	Oil-rubbed bronze
SN	Satin nickel

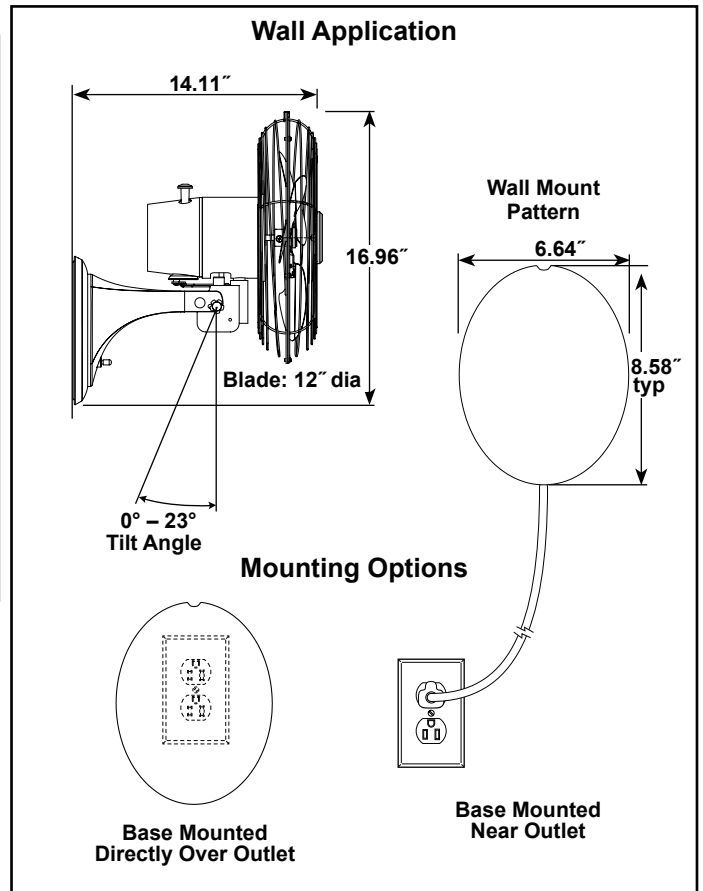

ELECTRICAL REQUIREMENTS:

Requires a grounded electrical supply line of 120 volts AC, 60 Hz, 15 amp circuit. 8 ft power cord included.

MOTOR SPECS:

74 x 18 motor is designed for optimal performance with this fan.

CONTROL / SPEED:

3-speed rotating switch (on back of motor). Approximate speeds High—1280 rpm; Med—970 rpm; Low—830 rpm

FEATURES:

- Included 8 ft power cord with replace fuse.
- Oscillates 50°
- Can be mounted on wall, near or directly over outlet (mounting bracket included)
- Includes protective rubber pad in button of base
- Weighs 11 lbs
- Ships fully assembled

LOCATION USE:

Fan is using in dry and damp locations.