

ASSEMBLING & INSTALLATION INSTRUCTIONS FOR PRODUCT# 6470

For Ceiling Mount Fixtures

WARNING! SHUT POWER OFF AT FUSE OR CIRCUIT BREAKER .

MOUNTING THE FIXTURE (Fig.1)

1. Shut off the power at the circuit breaker box. Remove old fixture and all hardware from Junction Box.
2. Carefully unpack your new fixture and lay out all the parts on a clear area. Take care not to lose any small parts necessary for installation.
3. Thread the pipe screw part way into the center hole of the single bar and secure with hex nut.
4. Attach the single bar to the junction box using two box screws. The side of the single bar marked "GND" must face out.
5. While holding the plate(A) assembly towards the ceiling, connect the electrical wires as Shown in Fig.2, making sure that all wire nuts are secured. You may have to wrap the connections with electrical tape. If your outlet has a ground wire (green or bare copper), connect the fixture ground wire to it. Otherwise connect fixture's ground wire directly to the Mounting strap with the green screw provided. After wires are connected, tuck them carefully inside the Junction Box.
6. Raise plate(A) onto the junction box, aligning pipe screw on single bar with center hole in plate and lock it securely with the ball nut(E).
7. Attach the glass shade(B) and collar ring(C) to bottom of the lamp socket, then lock it securely with ring(D) until snug.
8. Install the light bulbs in accordance with the fixture's specifications. **NOTE: DO NOT EXCEED THE SPECIFIED WATTAGE.**

Your installation is now complete. Return power to the junction box and test the fixture.

Fig.1

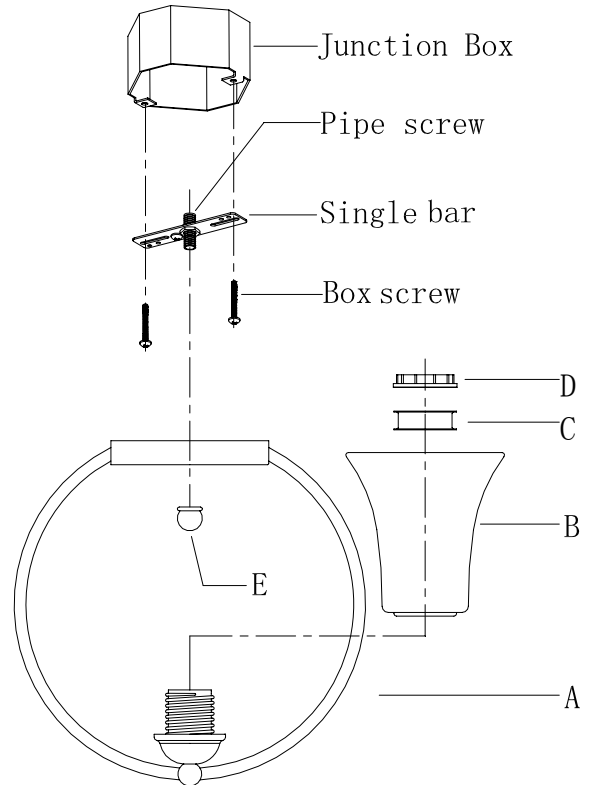

MIN 90°C SUPPLY CONDUCTORS

Fig.2

