

INSTALLATION INSTRUCTIONS FOR 4167

For Flush Mount Ceiling Fixtures

WARNING! SHUT POWER OFF AT FUSE OR CIRCUIT BREAKER .

MOUNTING THE FIXTURE (Fig.1)

1. Shut off the power at the circuit breaker box. Remove old fixture and all hardware from Junction Box.
2. Carefully unpack your new fixture and lay out all the parts on a clear area. Take care not to lose any small parts necessary for installation.
3. Attach the mounting screw part way into the side hole of the crook cross bar, then lock it securely with hex nut until becoming.
4. Attach the cross bar to the Junction Box with the two Box screws as shown. The side of the cross bar marked "GND" must face out.
5. While holding the column assembly towards the ceiling, connect the electrical wires as Shown in Fig.2, making sure that all wire nuts are secured. You may have to wrap the connections with electrical tape. If your outlet has a ground wire (green or bare copper), connect the fixture ground wire to it. Otherwise connect fixture's ground wire directly to the Mounting strap with the green screw provided. After wires are connected, tuck them carefully inside the Junction Box.
6. Put fixture body (A) onto the junction box, aligning screws on mounting strap with mounting holes in canopy and lock it securely with the ball nut(G).
7. Thread pipe frame(C) into the nipple bottom of fixture body, then fix it tightly with hex nut (B).
8. Install the light bulbs in accordance with the fixture's specifications. **NOTE: DO NOT EXCEED THE SPECIFIED WATTAGE.**
9. Attach the glass shade(D) to the fixture body (A), then fasten the screw (C) and attach the cover (E) using the finial (F) by turning it clockwise until tight.

Your installation is now complete. Return power to the junction box and test the fixture.

Fig.1

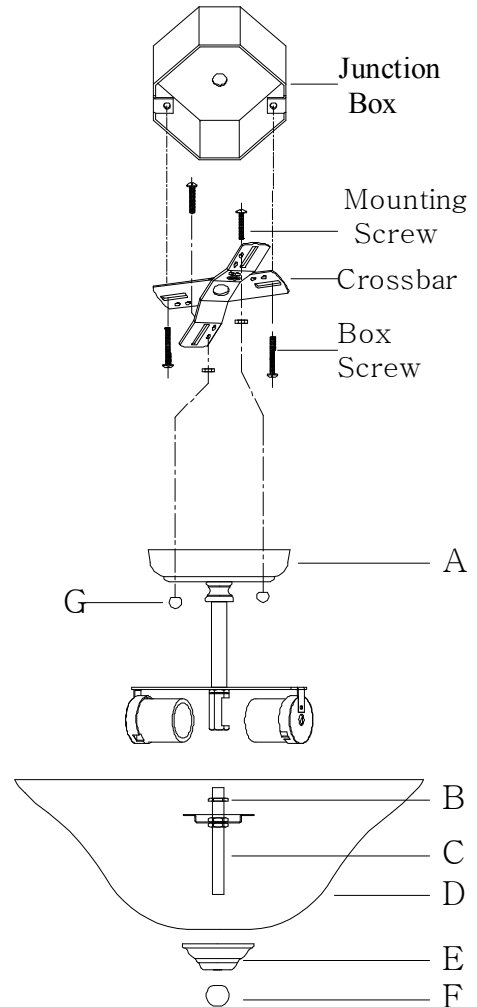

MIN 90°C SUPPLY CONDUCTORS

Fig.2

