

Middle Atlantic Products

EXCEPTIONAL SUPPORT & PROTECTION™



TOR Series Tilt Out Wall Rack

Ideal for small sound systems, paging and patching applications in schools, hotels, offices or anywhere a secure, low-profile wall mount solution is required

Features

- Convenient design allows easy access to equipment controls
- Two models available: surface mount or flush between studs
- Tamper resistant design ideal for use in non-secure areas
- Front rackrail is adjustable from 1-1/2" to 3-1/2" from top to accommodate handles and knobs
- Mount non-rackmount equipment using included clamp bars
- Engineered to provide effective passive thermal management
- Includes removable panel to accommodate Middle Atlantic Products UCP series universal connector panels, mounts BNC, XLR and other popular connectors
- Knockout provided in back box for cable pass-through
- Knockouts on face of rack accept Decora® style low-voltage switches or devices
- Abundant cable management tie points integrated throughout enclosure
- Includes electrical box for high-voltage connections
- Available in 2, 3, or 4 rackspaces
- Up to 20" useable depth with a 100 lb. weight capacity
- UL Listed in the US and Canada



TOR SERIES
(open in operation position)



(closed position)

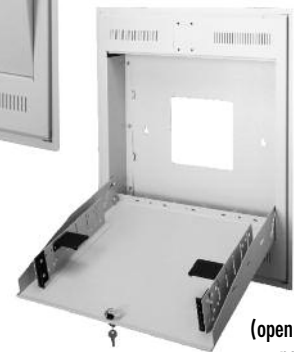

(open in service position)

Architects' and Engineers' Specifications

EIA/TIA compliant 19" tilt out wall rack shall be Middle Atlantic Products model #TOR-X-20XX (refer to chart). Overall dimensions shall be 24.5" W x 30.2" H x XX" D (refer to chart). TOR rack shall be constructed of 18-gauge steel, ears and fascia shall be constructed of 16-gauge steel. TOR shall have a weight capacity of 100 lbs. Rackrail shall be constructed of 11-gauge steel with tapped 10-32 mounting holes in universal EIA spacing with black e-coat finish and marked rackspaces. TOR-(3/4)-20 SP/RP shall include 4" x 4" electrical box, TOR-2-20 SP/RP shall include 4" x 2-1/8" electrical box. TOR Series shall include two Decora R style knockouts at top face of rack. Cable management features shall include a 8.5" X 8.5" cable pass-through on backpan, abundant cable tie points and electrical cable duct knockouts on top, bottom for electrical connections. TOR shall pivot X degrees with positive stop for unit operation and 105 degrees with positive stop for servicing (refer to chart). TOR shall be UL Listed in the US and Canada. TOR shall be GREENGUARD Indoor Air Quality Certified for Children and Schools. TOR shall be RoHS EU Directive 2002/95/EC compliant. TOR shall be manufactured by an ISO 9001 and ISO 14001 registered company. TOR shall be warranted to be free from defects in material or workmanship under normal use and conditions for the lifetime of the product.

OPTIONS

- Partial recess trim kit for mounting between 2 x 4 or 2 x 6 studs (refer to chart) shall be Middle Atlantic Products model #TOR-PRT

CUSTOMIZABLE SPECIFICATION CLIPS AVAILABLE AT MIDDLEATLANTIC.COM

TOR Series basic dimensions

All dimensions in inches unless otherwise noted
[All bracketed dimensions are in millimeters]

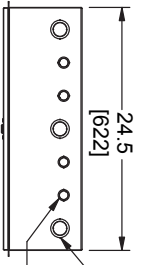

TOP VIEW

1" [25] & 1.5" [38] combo EKO (6 places)
.5" [13] & .75" [19] combo EKO (7 places)

FRONT VIEW

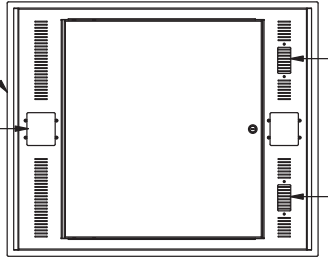

SIDE VIEW

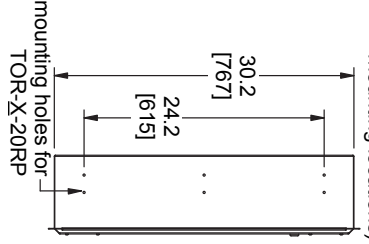
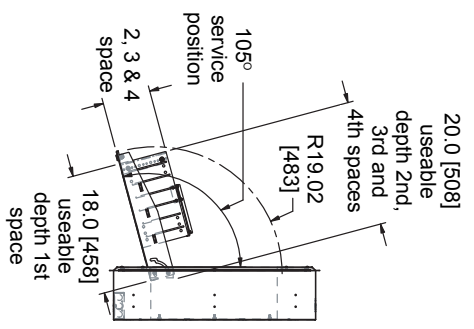
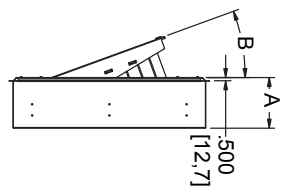
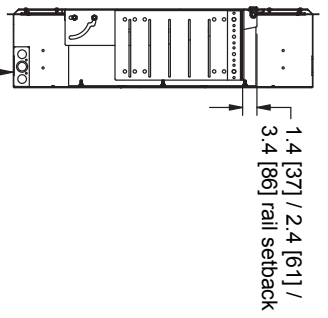

25.7 [653] x 31.4 [798] fascia (refer to chart)

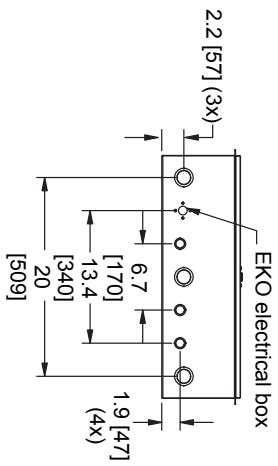
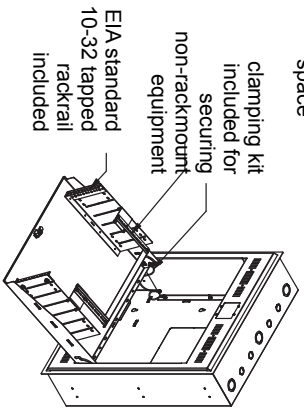

REAR VIEW (TOR-X-20SP surface mount mounting locations)

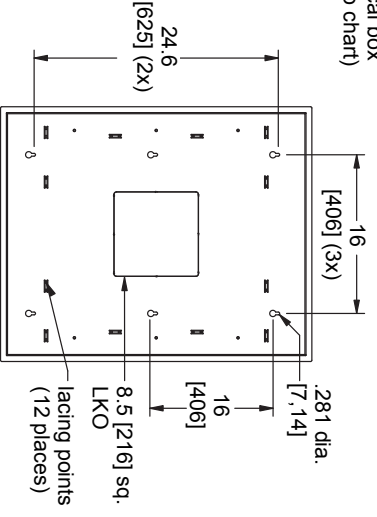

PART#	'A' OVERALL DEPTH	'B' OPERATING POSITION	ROUGH OPENING	RECOMMENDED STUD SIZE FOR FLUSH MOUNT	FASCIA	ELECTRICAL BOX	OPTIONAL PARTIAL RECESS FASCIA	RACKING HEIGHT	MOUNT METHOD
TOR-2-20RP	4.44 [113]	12°	24.75 [629] x 30.31 [770]	2" x 4"	included	4" x 2-1/8"	-	3-1/2" (2 space)	Flush Mount
TOR-3-20RP	6.19 [157]	18°	24.75 [629] x 30.31 [770]	2" x 6"	included	4" x 4"	TOR-PRT*	5-1/4" (3 space)	Flush Mount
TOR-4-20RP	7.94 [202]	20°	24.75 [629] x 30.31 [770]	2" x 8"	included	4" x 4"	TOR-PRT**	7" (4 space)	Flush Mount
TOR-2-20SP	4.38 [111]	12°	-	-	-	4" x 2-1/8"	-	3-1/2" (2 space)	Surface Mount
TOR-3-20SP	6.13 [156]	18°	-	-	-	4" x 4"	-	5-1/4" (3 space)	Surface Mount
TOR-4-20SP	7.88 [200]	20°	-	-	-	4" x 4"	-	7" (4 space)	Surface Mount

* For use when mounting in a 2 x 4 studded wall
** For use when mounting in a 2 x 4 or 2 x 6 studded wall