







Fixture Name: Alston Place 8118-BA4 PW

This fixture assembled PO: _____ Date: _____

Notice: Please review the parts listing and check for all parts before assembling the fixture. If any parts are missing or damaged, please note on this sheet and contact the place of purchase to arrange for replacement parts.

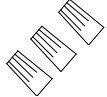
PARTS LIST

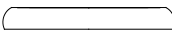
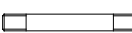
Company Name: _____ Co. Account #: _____
to be filled out by retailer

Mounting Strap  1ea $\varnothing 4'' \times H2\text{mm}$	Mounting Screws  2ea 8#32-IP*1"	Deco Nut  2ea 5/32-IP*H9mm
Wire connectors  3ea P3 Orange	Mounting Screws  2ea 5/32-IP*7/8"	Hex Nut  2ea 5/32-IP*H3mm
Cap  2ea $\varnothing 1-1/2'' \times H5\text{mm}$	Nipple  2ea 5/32-IP*H45mm	Crystal ball  2ea $\varnothing 1-1/2'' \times H32\text{mm}$
Finial  2ea $\varnothing 3/4'' \times H34\text{mm}$		

Part Needed _____	Quantity _____
Part Needed _____	Quantity _____
Reason why (missing, scratched, broken glass, bent, bad finish)	
Comments _____	

FIXTURE ASSEMBLY INSTRUCTIONS

Read and review installation instruction sheet, but do not install before assembling the fixture.

1. Thread Nipple (R) onto end of fixture bar. Put Cap (S), then Crystal Ball (T) onto Nipple (R) and secure with Finial (U).
2. Repeat for other side.
3. Slide the Glass Shade (J) over Socket (I). Secure Glass Shade (J) by threading the Socket Ring (O) onto Socket (I) until tight.
4. Install the light bulb in accordance with the fixture's specifications.
DO NOT EXCEED MAXIMUM WATTAGE RATING!

NOTE: INSTALL THE GLASS ASSEMBLY AFTER THE FIXTURE IS HUNG.

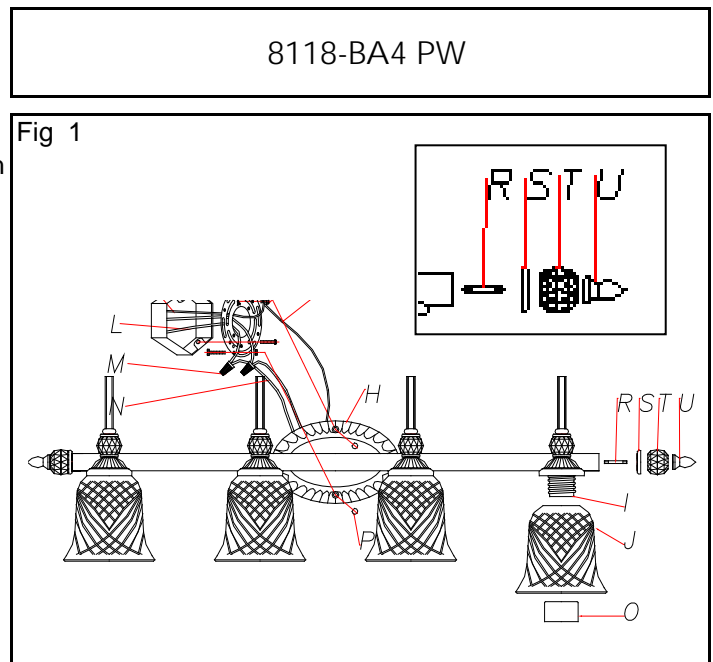

For Customer Service, contact the place of purchase to arrange for replacement parts.

WARNING ! SHUT OFF POWER AT FUSE OR CIRCUIT BREAKER.

HANGING THE FIXTURE (Fig.1)

1. Carefully remove the new fixture from the carton and the yellow bag that holds all your parts. Check that all parts are included as shown in the illustration and parts list.
2. Shut off power at the circuit breaker and remove the old fixture from wall, including the old mounting strap.
3. The Mounting Strap (F) contains several pairs of threaded holes, find the pair of holes that match the holes spacing in your fixture Back Plate(H) and thread the two Mounting Screws(D) half way into the Mounting Strap (F) and secure with Hex Nut (G).
4. Place the Mounting Strap (F) over the Junction Box (A) so the Mounting Screw s(D) are vertical or horizontal, as required by fixture type.
5. Attach the Mounting Strap (F) to the Junction Box using the two mounting screws (H) and tighten securely with screw driver.

CONNECTING THE WIRES (Fig. 2)

6. Attach the power supply wires to the fixture lead wires by connecting BLACK to BLACK (or SMOOTH) and WHITE to WHITE (or RIBBED).
 7. Attach the GROUND wire(GREEN or COPPER) from the Junction Box and the fixture Ground wire to the green Ground Screw (I) on the Mounting Bracket (F) or connect both wires together using a wire connector.
- NOTE: Twist the wires together in the same direction you twist the wire connector (L) onto the wires.
8. Tuck these wire connections neatly into the Junction Box.

FINISHING THE INSTALLATION (Fig. 3)

9. After tucking these wire connections neatly into the Junction Box, place the fixture Back Plate(H) over the two Mounting Screws (B).
 10. Secure the Back Plate (H) against the wall by threading two Deco Nuts (P) over the two Mounting Screws (D) until tight as shown on Fig.1.
 11. Install the light bulbs and glass shade as per the fixture assembly sheet.
- YOUR INSTALLATION IS NOW COMPLETE. RETURN POWER TO THE JUNCTION BOX AND TEST THE FIXTURE.

Fig. 1

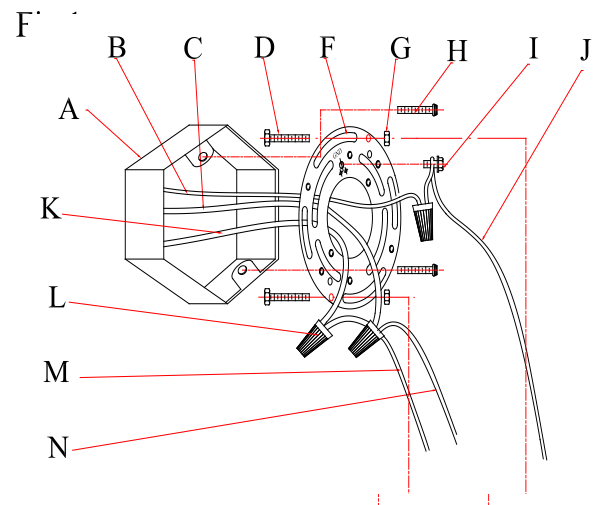

Fig. 2

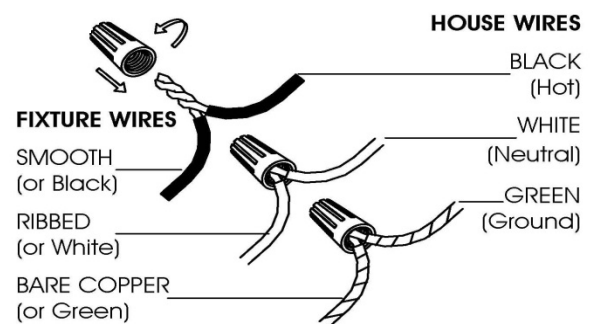

Fig. 3

