



Model No.: M661/662

PO #:

Serial #:

Convertible Crib and Changer (M661/662)



THIS PRODUCT IS NOT INTENDED FOR INSTITUTIONAL OR COMMERCIAL USE.

If you have any questions or missing parts, please contact us. DO NOT return product parts to the store where it was purchased before contacting AFG Customer Service.

AFG Customer Service:

E-mail: service@afgbabyfurniture.com

Tel: (323) 722-6268

 **WARNING:** Failure to follow these warnings and the assembly instructions could result in serious injury or death. Read all instructions BEFORE assembly and USE of product. KEEP INSTRUCTIONS FOR FUTURE USE.

- First remove hardware from box and sort by size. Check to see that all hardware and wooden pieces are present before assembling.
- Follow instructions listed below in the proper sequence as numbered to assure fast, easy and correct assembly.
- DO NOT use this crib if the enclosed or attached instructions cannot be strictly adhered to.

 **WARNING:**

- DO NOT attempt to repair or modify parts with cracks or defects. Please contact us for immediate replacement.
- This product is for home use and is not intended for use in schools, day care centers or other commercial establishments.
- Must be assembled by a capable adult.
- **CHOKING HAZARDS:** DO NOT put small / loose components on top of the unit where baby could reach.

Crib Warning

 **CAUTION:** Any mattress used in this crib should be at least 27-1/4 by 51-5/8 in. with a thickness not exceeding 6 in.

-  **WARNING:** Infants can suffocate on soft bedding. Never add a pillow or comforter. Never place additional padding under an infant.
- This crib conforms to applicable regulations promulgated by the Consumer Products Safety Commission.
 - Never use plastic shipping bags or other plastic film as mattress covers.
 - Infants can suffocate in gaps between crib sides and a mattress that is too small.
 - To reduce the risk of SIDS, pediatricians recommend healthy infants be placed on their backs to sleep, unless otherwise advised by your physician.
 - DO NOT use a water mattress with this crib.
 - Do not remove any wood screws in the normal disassembly of the crib.
 - Replace teething rail if damaged, cracked or loose.
 - If refinishing, use a non-toxic finish specified for children's products.
 - Follow warnings on all products in a crib.

Strangulation Hazard

- Strings can cause strangulation! Do not place items with a string around a child's neck, such as hood strings or pacifier cord. Do not suspend strings over a crib or attach strings to toys.
- To help prevent strangulation, tighten all fasteners. A child can trap parts of the body or clothing on loose fasteners.
- DO NOT place crib near windows where cords from blinds or drapes may strangle a child.

Fall Hazard

- When child is able to pull to a standing position, set mattress to lowest position and remove bumper pads, large toys and other objects that could serve as steps for climbing out.
- Stop using crib when child begins to climb out or reaches the height of 35 in. (89 cm).
- Check this product for damaged hardware, loose joints, loose bolts or other fasteners, missing parts, or sharp edges before and after assembly and frequently during use. Securely tighten loose bolts and other fasteners.
DO NOT use crib if any parts are missing, damaged or broken. Contact (AFG International Products Inc) for replacement parts and instructional literature if needed. DO NOT substitute parts.

Storage: The crib must be kept in a dry and clean area. Solid wood tends to exchange moisture with the surrounding air and reacts to major changes in temperature and humidity. The ideal environment for the crib is at a temperature between 65 and 75 degrees and a relative humidity between 35 and 40 percent. If the room is too humid, the crib will absorb moisture and expand; in verse, the crib will lose moisture and shrink in a dry environment. It is best to place your furniture away from heating or air-conditioning vents. Also, direct exposure to sunlight can discolor the wood, so do not place your product where it will receive prolonged sunlight exposure.

Care and Cleaning: Do not scratch or chip the finish. Do not use abrasive chemicals for cleaning. Clean with mild soap on a soft rag. Rinse and dry thoroughly. If you choose to refinish this furniture, be sure to use only a non-toxic finish specified for children's products.

Changer Warnings

WARNING- KEEP THE INSTRUCTIONS FOR FUTURE USE

FALL HAZARD: TO PREVENT DEATH OR SERIOUS INJURY ALWAYS KEEP CHILD WITHIN ARM'S REACH.

- NEVER LEAVE THE CHILD UNATTENDED.
- SECURE THE CHILD IN THE RESTRAINT WHEN USING CHANGER.
- KEEP THE CHILD IN VIEW WHILE CHILD IS IN THE CHANGER.
- STOP USING THE CHANGER WHEN THE CHILD IS ABLE TO SIT UP OR ROLL OVER.
- PERIODICALLY CHECK FOR LOOSE OR WORN PARTS, TIGHTEN, REPAIR, OR REPLACE AS NEEDED.
- THIS PRODUCT IS FOR RESIDENTIAL USE ONLY. ANY INSTITUTIONAL USE IS STRICTLY PROHIBITED.
- CAN ONLY RETAIN CHILD WITH MAXIMUM WEIGHT UP TO 30 LBS.
- ALWAYS SECURE CHANGING PAD TO THE CHANGER SURFACE BY FASTENING THE BELTS.
- DO NOT USE CHANGING TABLE, ADD-ON CHANGING UNIT, OR CONTOURED CHANGING PAD IF IT IS DAMAGED OR BROKEN.
- THIS PRODUCT IS NOT INTENDED TO BE USED AS A CHANGING TABLE WITHOUT FASTENING THE SAFETY BELT. USE OF THE PRODUCT WITHOUT THIS MAY RESULT IN DEATH OR SERIOUS INJURY TO YOUR CHILD FROM FALLING. FOLLOW ALL INSTRUCTIONS ON ATTACHING AND USING THE SAFETY BELT.
PARENT SHOULD ENSURE A SAFE ENVIRONMENT FOR THEIR CHILD BY CHECKING THE FURNITURE CAREFULLY BEFORE PLACING CHILD IN THE PRODUCT. PLEASE MAKE SURE EVERY COMPONENT IS PROPERLY AND SECURELY IN PLACE.

M661/662 Crib Parts Identification Sheet

DO NOT assemble crib if parts and hardware are defective or missing.
Contact AFG for exchange or keep the original box for return authorization.



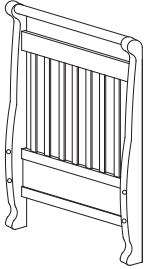
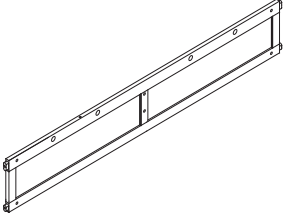
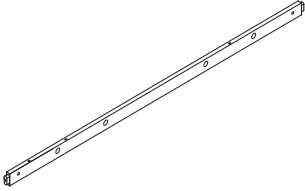
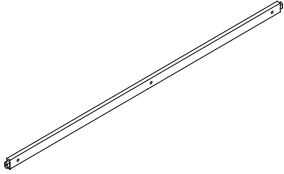
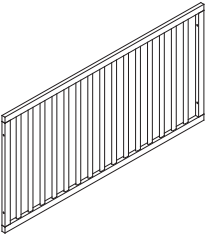
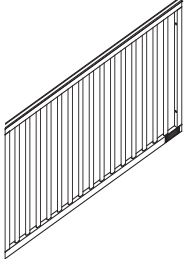
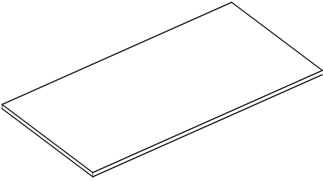
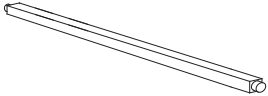
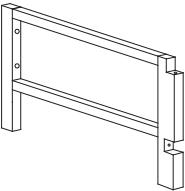
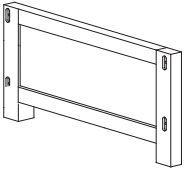
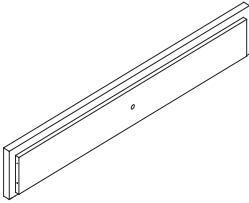
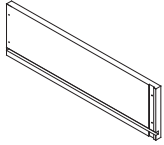
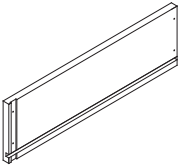
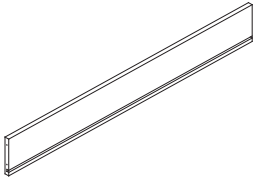
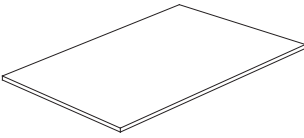



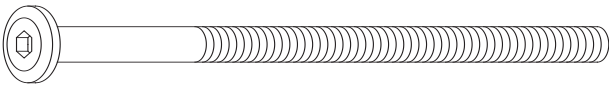
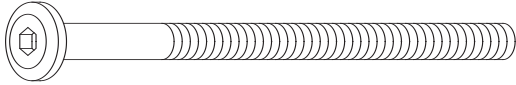
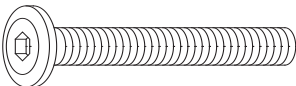

~ Crib Assembly Parts ~

<p>A. Headboard (1 pc)</p> 	<p>B. Fixed Side Bottom Panel (1 pc)</p> 	<p>C. Front Top Rail (1 pc)</p> 	<p>D. Front Bottom Rail (1 pc)</p> 
<p>E. Back Panel (1 pc)</p> 	<p>F. Front Panel (1 pc)</p> 	<p>G. Mattress Support Board (1 pc)</p> 	<p>H. Mattress Crossbar (4 pcs)</p> 
<p>I. Middle Side Panel (1 pc)</p> 	<p>J. Foot Board Bottom (1 pc)</p> 	<p>K. Drawer Front (2 pcs)</p> 	<p>L. Drawer Left Side (2 pcs)</p> 
<p>M. Drawer Right Side (2 pcs)</p> 	<p>N. Drawer Back (2 pcs)</p> 	<p>O. Drawer Bottom (2 pcs)</p> 	

M661/662 Hardware Identification Sheet

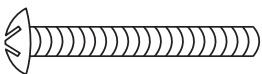
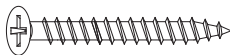
DO NOT assemble crib if parts and hardware are defective or missing.
Contact AFG for exchange or keep the original box for return authorization.

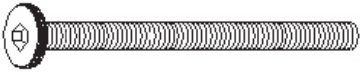
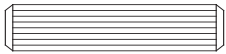
~ Crib Assembly Hardware ~

Item #	Fittings	Qty
1. Bolt 1/4" x 3"		(6 pcs)
2. Bolt 1/4" x 2-1/2"		(4 pcs)
3. Bolt 1/4" x 1-1/4"		(3 pcs)
4. Bolt 1/4" x 2-1/4"		(4 pcs)
5. Wood Dowel 8 mm x 20 mm		(2 pcs)
6. Nut 1/4" x 15 mm		(8 pcs)
7. Handle		(2 pcs)
8. Bolt 5/32" x 1-1/4"		(2 pcs)
9. Screw F4 x 1"		(16 pcs)
10. Wrench		(1 pc)
11. Bolt 1/4" x 1-3/4"		(4 pcs)
12. Wood Dowel 10 mm x 30 mm		(4 pcs)
13. Security Bracket		(2 pcs)

PHILLIPS SCREWDRIVER   (NOT INCLUDED)

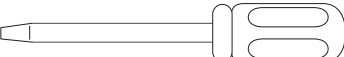
FLATHEAD SCREWDRIVER   (NOT INCLUDED)

M661/662 Changer Parts Identification Sheet

DO NOT assemble crib if parts and hardware are defective or missing.
Contact AFG for exchange or keep the original box for return authorization.

~ Changer Assembly Parts ~

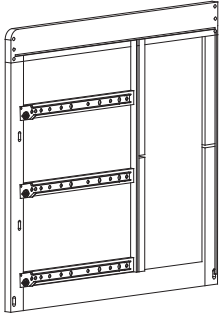
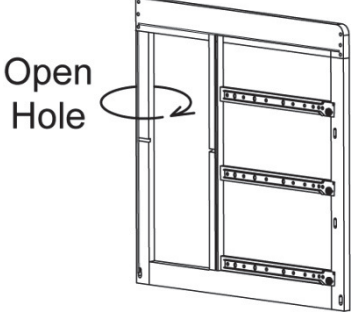
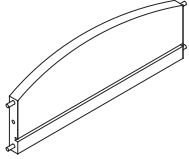
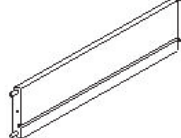
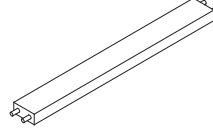
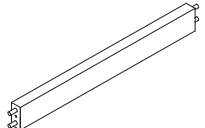
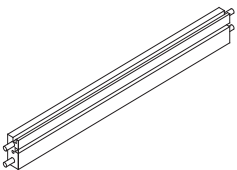
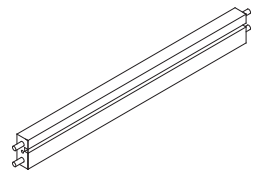
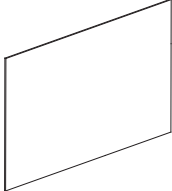
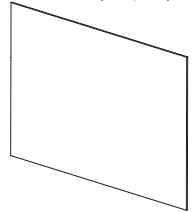
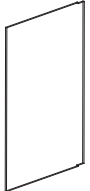
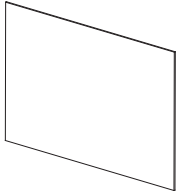
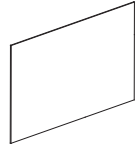
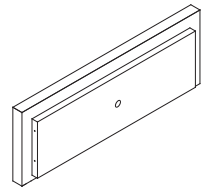
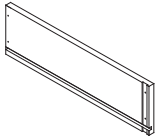
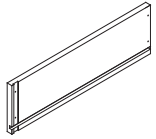
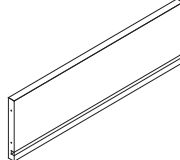
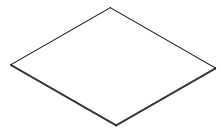
<p>A1. Left Panel (1 pc)</p> 		<p>A2. Right Panel (1 pc)</p> 	
<p>A3. Top Back Panel (1 pc)</p> 	<p>A4. Top Support Bar (1 pc)</p> 	<p>A5. Middle Support Bar (2 pcs)</p> 	<p>A6. Front Bottom Support Bar (1 pc)</p> 
<p>A7. Middle Bottom Support Bar (1 pc)</p> 	<p>A8. Back Bottom Support Bar (1 pc)</p> 	<p>A9. Dresser Top (1 pc)</p> 	<p>A10. Dresser Back Panel (1 pc)</p> 
<p>A11. Shelf Bottom (1 pc)</p> 	<p>A12. Dresser Middle (1 pc)</p> 	<p>A13. Shelf (1 pcs)</p> 	<p>A14. Drawer Front (3 pcs)</p> 
<p>A15. Drawer Left (3 pcs)</p> 	<p>A16. Drawer Right (3 pcs)</p> 	<p>A17. Drawer Back (3 pcs)</p> 	<p>A18. Drawer Bottom (3 pcs)</p> 

M661/662 Hardware Identification Sheet

DO NOT assemble crib if parts and hardware are defective or missing.
Contact AFG for exchange or keep the original box for return authorization.

~ Changer Assembly Hardware ~

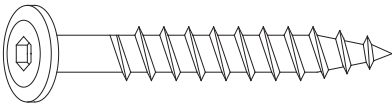
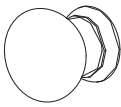
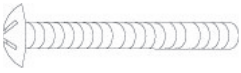
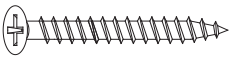
Item #	Fittings	Qty
S1. Screw 1/4" x 2"		(10 pcs)
S2. Handle		(3 pcs)
S3. Bolt 1/4" x 2-1/4"		(4 pcs)
S4. Screw F4 x 1"		(24 pcs)

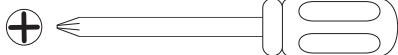
PHILLIPS SCREWDRIVER  (NOT INCLUDED)