

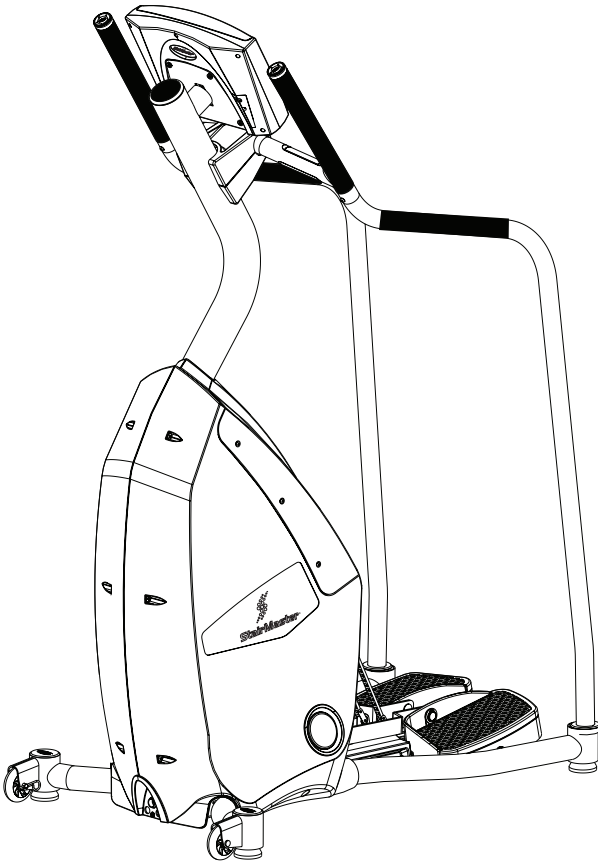

SC5 StairClimber



Owner's Manual



Introduction

Thank you for purchasing the StairMaster® Stair Climber 5. For more than 25 years StairMaster has been producing superior fitness equipment used in health clubs and homes around the globe. We hope this product exceeds your expectations and proves to be a valuable tool.

Read through this manual to familiarize yourself with the operation of your new SC5 StairClimber. Doing so will help to insure that you get the most out of your SC5 StairClimber, enjoying safe and effective workouts in the many miles ahead.

StairMaster
4400 NE 77th Ave, Suite 300
Vancouver, WA 98662
USA

1-888-678-2476
www.stairmaster.com

Table of Contents

Product Specifications	4
Safety Warning Labels	6
Getting Started	7
Operations D-1 LCD Console	8
Display Definitions and Functions.....	8
Key Functions.....	10
Programs	12
Quick Start Program	12
Manual Profile	12
Fat Burner Profile	13
Calorie Burner Profile	13
Intervals Profile	13
Heart Rate Zone Trainer Profile	13
Workout Program Options	14
CPAT Program	16
WFI Program	16
Heart Rate Monitoring.....	17
Telemetry Heart Rate	18
Console Codes	18
Machine Status Codes.....	20
Diagnostic Codes.....	21
Configuration Codes	23
Operations TS-1/TSE-1 Console	25
Display Definitions and Functions.....	25
Button Functions.....	27
Programs	28
Quick Start Program	29
Manual Profile	29
Fat Burner Profile	29
Calorie Burner Profile	29
Intervals Profile	30
Bell-Shaped Profile	30
Heart Rate Zone Trainer Profile	30
Workout Program Options.....	31
CPAT Test Program	32
WFI Test Program	32
Service Menu Options	34
Maintenance	36
Moving Your Machine	36
Schedule	37
Charging the Battery Backup	38
Battery Disposal & Recycling	38
Contacting StairMaster	39

Product Specifications

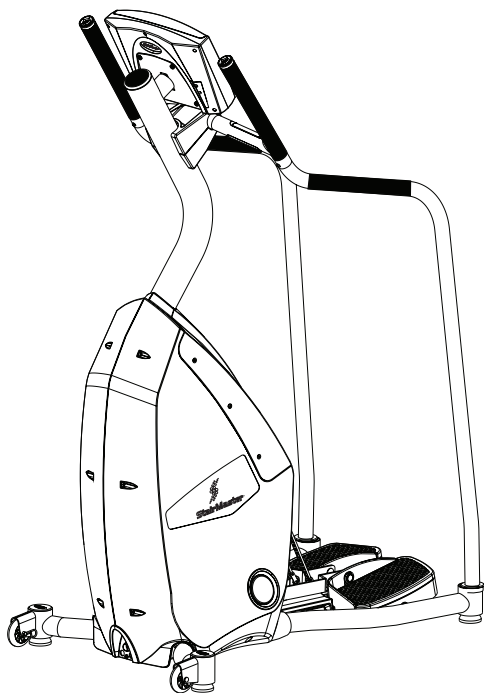

Model SC5

Dimensions: 27" W x 43" L x 68" H (68 cm x 109 cm x 173cm)

Unit Weight: 150 lbs (68 kg)

Shipping Package Weight: 178 lbs (81 kg)

Workout Area: 50" W x 81" L (127 cm x 205.74 cm)

Input Power Rating: 9V DC 1.00 Amps

External Power Adapter Ratings:

USA & Canada, 120V 60 Hz input, 9V DC 1.5 A output

Japan, 100V 50-60 Hz input, 9V DC 1.5 A output

International (EU & Australia/New Zealand), 230V (or 220-240V) 50 Hz input, 9V DC 1.0 A output

Max user weight: 300lbs (136 kg)

Important Safety Instructions



This icon means a potentially hazardous situation which, if not avoided, could result in death or serious injury.

Before using this equipment, obey the following warnings:



Read and understand the complete Owner's Manual.

Read and understand all Warnings on this machine.

- If this machine is being used in a commercial setting, end users may not have access to this Owner's Manual. It is the responsibility of the facility to instruct users as to the proper usage of the equipment, as well as making them aware of potential hazards.
- Keep children away from this machine. Watch them closely when near the machine. Moving parts that appear dangerous to adults may not appear so to children.
- Consult a physician before starting an exercise program. Stop exercising if you feel pain or tightness in your chest, become short of breath, or feel faint. Contact your doctor before using the machine again.
- Examine this machine for loose parts or signs of wear. Pay special attention to the pedals. Contact StairMaster® Customer Service for repair information. Use only genuine StairMaster® replacement parts.
- Set up and operate your StairClimber on a hard, level surface.
- Do not wear loose clothing or jewelry while exercising.
- Maximum user weight limit: 300 lb. (136 kg). Do not use if you are over this weight
- Stabilize the pedals before stepping on them and use caution when stepping off the machine.
- Keep at least 19 inches (50 cm) clear area around the machine. This is the recommended safe distance for access and passage around and emergency dismounts from the machine.
- Warn bystanders to keep a safe distance, at least 3 feet (1 m). Do not allow anyone to touch the operator while the machine is in motion.
- Do not over exert yourself during exercise. Do not try to exercise with more resistance than you can physically handle.

When you use an electrical appliance, basic precautions must always be followed, including the following:

DANGER – To decrease the risk of electric shock always unplug this appliance from the electrical outlet immediately after use and before cleaning.



To decrease the risk of burns, fire, electric shock, or injury to persons:

- An appliance must not be left unattended when plugged in. Unplug from outlet when not in operation, and before you put on or removing parts.
- Close supervision is necessary when this appliance is used by or near children or disabled persons.
- Use this appliance only for its intended use as described in this manual. Do not use attachments that are not recommended by the manufacturer.
- Do not operate this appliance if it has a damaged cord or plug, if it is not working correctly, if it has been dropped or damaged, or fallen into water. Return the appliance for examination and repair.
- Keep the cord away from heated surfaces.
- Do not drop or put any object into any opening.
- Do not use outdoors.
- To disconnect, turn all controls to the off position, then remove plug from outlet.

KEEP THESE INSTRUCTIONS

Safety Warning Labels

Before Using Your Product: Find and read all warning labels located on the StairMaster® SC5, prior to using your product be sure to replace any warning label if damaged, illegible, or missing . If you need replacement labels, please call a StairMaster® representative at 1-888-678-2476.

Label 1: General warning label.

Location: Affixed to the lower front of the left side cover (see Figure 1).

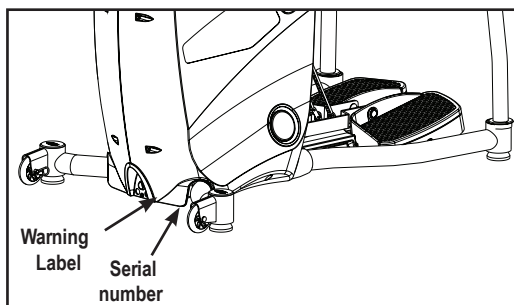

Figure 1

Label 2: General exercise warning label.

Location: Affixed to the mast below the console (see Figure 2).

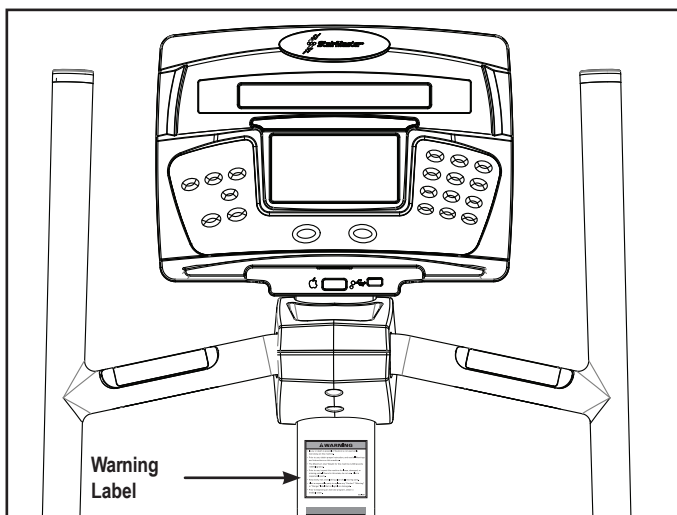

Figure 2

Getting Started

Note: Throughout this manual, all references to the left or right side and to the front or back, are made as if you were on the machine, ready to exercise.

Guidelines for Getting On and Off the SC5 StairClimber:

Instruct each user in the following guidelines for getting on and off the StairClimber.



To avoid injury, please carefully follow the instructions.

1. You should see the CHOOSE WORKOUT GOAL message on the display.
2. Select the QUICK START exercise program so you can control the pace of your first workout and get used to the exercise motion.
3. As you become comfortable with exercise motion, press [Level ↑] and [Level ↓] to adjust the step rate.
4. Relax while exercising.
5. Before stepping off the StairClimber, stop and let the pedals slowly bring you to the floor. Use the Side rails for support and lift one foot slowly until the pedal arm contacts the upper stop. Place that foot on the floor. Repeat for the other foot. Do not let the pedals slam into the upper stops, since this may cause unnecessary wear and tear.

Operation - D-1 LCD Console

Understanding the Display and Controls

The SC5 console is a computerized panel used to operate the StairClimber® 5 display workout data and operational status. Take time to read through and familiarize yourself with the operation of the SC5, and the location of all keys, to take full advantage of all of your machine's workout options.



Display Definitions and Functions

Computer Display and Functions:

- TIME** The selected workout time is displayed in the left section of the upper display window. In most of the workouts, the timer will count down, in minutes and seconds, until the workout is finished or stopped. If (0) is entered in the (MANUAL) or (HR ZONE TRAINER) workout, the timer will count up.
- INTERVAL TIMER** The interval timer is displayed in the center of the lower display. The interval timer counts down the remaining time within each interval.
- LEVEL** Pressing the ↑ key increases the workload intensity. Pressing the ↓ key decreases the workload intensity.

Operation - D-1 LCD Console

HEART RATE Current Heart Rate (HR), in Beats Per Minute (BPM), is displayed next to the heart icon on the upper display.

 **User should consult a physician to determine an appropriate Target Heart Rate (THR) in which to exercise, based on age, weight and physical condition.**

CALORIES Provides a current total of the number of calories burned during a workout.

Note: This number is only an approximation as a user's caloric expenditure will vary significantly based on a person's age, gender, weight and metabolism.

FLOORS PER MINUTE Displays the step rate in floors per minute (FPM).

LEVEL Displays the current level from 1-20.

FLOORS Displays the current number of floors climbed.

WATTS During a workout, this statistic displays the power output at the current RPM and intensity level, displayed in watts (746 watts = 1 hp).

METs MET (multiple of the resting metabolic rate) indicates the relative energy cost of exercise. While you are sitting quietly, your body consumes oxygen at the rate of 1 MET or about 3.5 milliliters per kilogram of body mass per minute. When you exercise, your body needs more oxygen in order to function. For example, exercising at 10 METs requires 10 times the resting rate of oxygen consumption, or about 35 milliliters per kilogram per minute. During a workout, the display shows the current MET level. During the workout summary, the average MET level is displayed. During your workout, keeping track of the METs will show you how hard you are working—the higher the MET level, the harder you are working.

WORKOUT PROFILE The dot-matrix area of the lower display shows the actual course profile of the selected exercise program. The taller the column, the higher the step rate and/or METs for that interval. The flashing column shows your current interval.

Operation - D-1 LCD Console

Key Functions

Workout Selection Keys

The Workout Selection Keys are located to the left of the display. There are 3 keys to select a Workout Goal, and one key for More Workouts which includes multiple advanced workout options.

While the console is in SELECT WORKOUT mode, pressing one of the Workout Goal keys (Time, Calories, or Floors) will select the goal, and screen will prompt to enter the specific goal information for the program chosen.

Once the goal is entered you will be prompted to select a workout profile - use UP ↑ and DOWN ↓ arrow keys to scroll through the profile options, ENTER selects the option. Profile options are: Manual, Fat Burner, Calorie Burner, Intervals, Bell-shaped, Build, Mystery Challenge, and Steady. See below for descriptions of each profile.

Once the profile option is selected, screen will prompt to SET INTENSITY, from 1 (easiest) - 9 (hardest). Use number keys and/or up/down arrows to set desired intensity, ENTER to select.

After intensity is selected, screen will prompt to ENTER WEIGHT (in either lbs or kgs depending on setting of console) which is used for calorie calculation. Use number keys and up ↑/down ↓ arrows to set desired weight, ENTER to select. If no weight is entered, machine will use default of 160 lbs/65 kg.

MORE WORKOUTS

Pressing the More Workouts key provides access to three advanced workout options: HR Zone Trainer, CPAT Test and WFI Test. Use UP and DOWN arrow keys to scroll through the profile options, ENTER selects the option.

QUICK START KEY The Quick Start Key provides an immediate start to a workout session without having to provide any user information.

LEVEL (STEP RATE) UP & DOWN KEYS The exercise Step Rate may be changed at any time during workout. Pressing the ↑ key increases the step rate and pressing the ↓ key decreases the step rate.

STOP KEY Press the STOP Key any time you want to pause the workout program for up to 2 minutes. Press the STOP Key a second time,

Operation - D-1 LCD Console

and the workout statistics will be displayed, then the console will return to the SELECT WORKOUT prompt.

NUMERIC KEYPAD (0-9) The numeric keypad is located on the right side of the console. During program setup, this keypad allows you to quickly enter requested information such as Time, Age, Intensity Level , Weight and HR.

Enter: The ENTER Key confirms workout selections and stores the information used by the console to calculate workout statistics.

Clear: During data entry, the CLEAR Key erases information from the console memory and backs up to the previous data entry prompt.

PROGRAMS



Operation - D-1 LCD Console

Time Goal

Time goal program allows you to enter a set amount of time you want to work out, and workout will continue over 30 time intervals to complete in desired amount of time.

Floor Goal

Floor Goal program allows you to enter a set number of floors you would like to climb during your workout. Based on your selected level of intensity, the console will calculate how long it will take you to complete the desired number of floors and workout will continue until completion.

Calorie Goal

Calorie Goal program allows you to enter a set number of calories you would like to burn during your workout. Based on your selected level of intensity, the console will calculate how long it will take you to burn the desired number of calories and workout will continue until completion.

The Quick Start Program

Provides an immediate start, without having to enter any user information. This program uses the standard default settings to calculate calories burned during a workout session.

1. Press the [QUICK START] key. The workout begins with exercise statistics accumulating.
2. During the workout:
The step rate may be changed at any time during the workout by pressing the [Level: UP] key to increase the step rate, or the [Level: DOWN] key to decrease the step rate. Any changes to the step rate will be displayed in the current flashing column. The new step rate will continue through the rest of the workout until changed using the Level keys.
3. Press [STOP] to pause the workout. Press [STOP] again to end the workout. The workout statistics will be displayed, and then the console will revert back to the SELECT WORKOUT message.

Manual Profile

Manual allows you to control the step rate of the StairClimber® 5 during the workout, while accurately calculating exercise statistics based on your weight. The workout profile in the display window is divided into 30 equal intervals within the selected workout time.

Operation - D-1 LCD Console

Fat Burner Profile

Fat Burner is a 30-interval workout designed with moderate changes in intensity level designed to stimulate fat store assimilation for users on a weight control program. Any changes to speed during workout will change levels for rest of workout.

The Calorie Burner Profile

Calorie Burner is a 30 interval workout designed for users wanting to increase their aerobic capacity. The changes of the intensity in the program are greater than the changes in the Fat Burner program, and are designed specifically to tax the cardiorespiratory system. The profile in the center display indicates relative intensity. Any changes to speed during workout will change levels for rest of workout.

The Intervals Profile

Intervals is an interval workout containing 8 alternating rest intervals with 7 exercise intervals.

An interval cycle consists of a work phase and a rest phase. You may scale the rest intensity level and the work intensity level independently—which will be saved for the remainder of the workout.

Bell-Shaped Profile

The Bell-shaped is a 30 interval workout that steadily increases intensity for the first half of the workout, and then decreases over the second half of the workout. Any changes to Level during the workout will alter the remaining intervals in the profile by the same amount.

Build Profile

The Build is a 30 interval workout that steadily increases intensity over the course of the workout. Any changes to Level during the workout will alter the remaining intervals in the profile by the same amount.

Mystery Challenge Profile

The Mystery Challenge is a 30 interval workout with intensity changes randomly selected and applied to create a unique workout profile every time. Any changes to Level during the workout will alter the remaining intervals in the profile by the same amount.

Steady Profile

The Steady is a 30 interval workout that includes a warm-up period, then goes to a selected intensity level and remains there for the duration of the workout. Any changes to Level during the workout will alter the remaining intervals in the profile by the same amount.

Heart Rate (HR) Zone Trainer Profile

The HR Zone Trainer program allows you to exercise at a selected THR by automatically

Operation - D-1 LCD Console

varying the intensity level (resistance) during the workout. The default THR is 100 beats per minute.

To choose a different THR (between 50 and 190 beats per minute) at any time during the workout, use the numeric keypad to enter the new THR, followed by the [ENTER] key.

The HR Zone Trainer program:

1. Program requires telemetry HR chest belt. Remember to wet the electrodes underneath the chest strap. The console must detect a HR signal to allow selection of the HR Zone Trainer program.
2. After selection, the console will first display Checking for HR. When the console detects a valid signal from the HR belt it will then proceed to the next step.
3. The console will then display CHOOSE GOAL button, TIME- CALORIES-FLOORS. Push one of the three goal buttons to the left of the screen.
4. The console will then prompt to enter goal information for selected goal.
5. Once goal information is selected...screen will prompt to ENTER WEIGHT (in either lbs or kgs depending on setting of console) which is used for calorie calculation. Use number keys and up/down arrows to set desired weight, ENTER to select. If no weight is entered, machine will use default of 160 lbs/65 kg.
6. The workout will begin.

The following message may be displayed during a workout:

CHECK HR BELT	Indicates that the telemetry HR signal has been missing for the last 30 seconds.
----------------------	--

7. Press [STOP] to pause the workout. Press [STOP] again to end the workout. The workout statistics will be displayed, and then the console will revert back to the SELECT WORKOUT message.

Options During a Workout

Once the workout begins, your workout statistics will begin to accumulate. The exercise statistics include, in order:

- **FLOORS/MIN**
- **FLOORS**
- **WATTS**

Operation - D-1 LCD Console

- **METS**
- **CALORIES**

Changing Step Rate (SR) or Target Heart Rate (THR) during a Workout

During the workout, the SR may be changed at any time during the workout by pressing the [Level: UP] key to increase the level, or the [Level: DOWN] key to decrease the level. The console will display STEP RATE.

In HR Control programs, you can use the numeric keys to change the THR. If the user presses a numeric key in a HR Control program, then the message line will display TARGET HR.

Once you enter your desired THR, press [ENTER] to accept, and the console will gradually change the resistance to move you to the new THR.

Pausing Your Workout

The program automatically enters the PAUSE state from a workout when the STOP key is pressed. The workout will be suspended, and the program will display the following alternating messages every 3 seconds for up to 2 minutes: WORKOUT PAUSED. PRESS STOP OR START.

When the program enters a PAUSE state, the interval timer begins to count down from 2 minutes to show you the time remaining in the pause condition.

To exit the PAUSE state:

- At the end of the two minutes count down, the current workout ends, the accumulated exercise statistics are scrolled, and the program returns to the opening message.
- If the user presses [STOP], then the program ends, the accumulated exercise statistics are scrolled, and the program returns to the opening message.
- If the user presses the [QUICK START] key, then the workout proceeds from where it was suspended.

End of Your Workout

The program is at the end of the workout when the workout goal is completed, or from the PAUSE state when the [STOP] key is pressed. At this point, each workout statistic is scrolled with averages calculated and displayed for TIME, CAL, Avg FLOORS/MIN, FLOORS, Avg WATTS, Avg METS.

After the statistics are scrolled, the program returns to the opening message.

Operation - D-1 LCD Console

CPAT Test Program

The first phase is a warm up interval at intensity of 56 step/min and lasts 20 seconds. At the end of the first interval the time counter will reset to zero.

The second phase continues through nine 20 second intervals at an intensity of 68 steps/min. The CPAT Stair Climb Test has a total of 10 intervals and lasts for 3 minutes, 20 seconds (including warm up).

Upon completion, screen displays TEST COMPLETE or INCOMPLETE.

WFI Test Program

The WFI test assesses the fire fighter's aerobic capacity expressed as VO_2 max. The results are calculated and recorded in milliliters (ml) of oxygen per kilogram (kg) of body weight per minute (VO_2 max).

These aerobic assessments are submaximal and are based on the heart rate response during graded exercise. Accurate estimation of maximal heart rate (MHR) is critical to the submaximal prediction used in these assessments. A new formula for calculating maximal heart rate is utilized with these protocols, it more accurately accounts for age-related reduction of MHR. Be aware that the heart rate can be affected by variables such as body temperature, hydration state, anxiety, stress and medications. In addition to heart rate, body mass (height-to-weight ratio), is also a significant variable in both prediction equations. The relationship between height and weight is recorded as Body Mass Index (BMI). It is important to note that BMI is not being used in these aerobic protocols to estimate body composition; but rather, is used to represent the mass of each participant.

The test starts at 46 steps/min for 2 minutes, then 53 steps/min for 1 minute (warm-up period). The test time includes the warm-up time. The test is a series of 1-minute intervals with increasing work loads on each subsequent minute.

Note: Once the test starts, the user should not maintain a hold or lean on the handrails; this will result in overestimation of aerobic capacity.

The test is complete when the heart rate exceeds the Target Heart Rate (THR) for 15 seconds. The total Test Time (TT) begins from the time the user starts on the StepMill, to the point at which the user exceeds their THR. It does not include the final 15 second qualification period that the heart rate was above the THR.

The qualification period is to verify the user's heart rate does not exceeds the target, and then drop down to the THR or below for 15 seconds, if it does, then the test continues.

$$\text{Target HR} = [208 - (0.7 * \text{Age})] * 0.85$$

$$\text{BMI (in - lbs)} = 703 * \text{Weight (lbs)} / \text{Height (inches)}^2$$

Operation - D-1 LCD Console

$BMI (cm - kg) = \text{Weight (Kg)} / \text{Height (cm}/100)^2$

$VO_2\text{max} = 57.774 + (1.757 \times \text{time}) - (0.904 \times BMI)$

Once the test is completed, the user should cool down for a minimum of 2 minutes at 39 steps/min.

The test is aborted with no results if any of the following occurs:

- The user stops or pauses the workout at any point during the test.
- The [STOP] key is pressed.
- The THR has not been met after 16 minutes previous work level.
- The Heart Rate signal is lost.
- The equipment malfunctions.

WFI Workout

1. Program requires telemetry HR chest belt. Remember to wet the electrodes underneath the chest strap. The console must detect a HR signal to allow selection of the HR Zone Trainer program.
2. After selection, the console will first display Checking for HR. When the console detects a valid signal from the HR belt it will then proceed to the next step.
3. Screen will walk you through entry of Weight, Age and Height information. These numbers are used in calculation of results, so for accurate results it is important to enter them correctly.
4. After successful completion of the WFI test, the following statistics will be displayed: EST VO2 MAX, HIGHEST STEP RATE, TOTAL TIME.

Heart Rate Monitoring

HR monitoring helps users monitor their levels of exertion by displaying the HR during exercise. There is one method of monitoring HR on the StairClimber® 5.



Pacemaker users should not use the telemetry transmitter without first consulting with their doctor.

- Telemetry (e.g. using a Polar® or Polar-compatible transmitter belt). A Polar-compatible HR chest belt transmits the heart beat signal to the receiver in the display. The display shows the HR in beats per minute and uses the HR value in HR control mode.

Operation - D-1 LCD Console

Telemetry Heart Rate

If your HR is not being displayed, try the following:

- Move closer to the display.
- Tighten the elastic band on the chest belt.
- Adjust the belt higher or lower on your chest.
- Remoisten the electrodes.
- Test your chest strap with a machine that you know is working, or with a HR watch that you know is working.

CONSOLE CODES

There are 4 groups of console codes as follows:

- Customization (codes starting with 2 or 3)
- Machine Status (codes starting with 4)
- Diagnostic (codes starting with 6 or 7)
- Configuration (codes starting with 8)

Each group of codes is defined below. To access these console codes and the options within each group, follow the instructions for each section.

Customizing the StairClimber® 5

You can customize several parameters on the StairClimber® 5 to conform to your individual requirements, including changing the workout default values and setting custom parameters such as time limits, changing screen contrast, changing language, and changing units.

To change the workout default values:

1. Press [Level: UP], [2], [ENTER]. The console will display DEFAULTS.
2. Press [Level: UP] or [Level: DOWN] to scan through the default choices. Select the option you want to change by pressing [ENTER]. Then use the [Level: UP] or [Level: DOWN] keys or the numerical keypad to change the value for the selected option. Press [ENTER] to accept the choice for that option.

DEFAULTS OPTIONS

Change default Weight

Use the numeric keypad or [Level: UP] or [Level: DOWN] keys to change the desired default weight for your facility. Press [ENTER] to accept the new value.

Operation - D-1 LCD Console

Change default Workout Time

Use the numeric keypad or [Level: UP] or [Level: DOWN] keys to change the desired default workout time between 5 and 180 minutes. Press [ENTER] to accept the new value.

Change default Age

Use the numeric keypad or [Level: UP] or [Level: DOWN] keys to change the desired default age used to calculate target HR. Valid age range is between 5 and 100. Press [ENTER] to accept the new value.

Change default Starting Level

Use the numeric keypad or [Level: UP] or [Level: DOWN] keys to change the desired default level between 1 and 20. Press [ENTER] to accept the new value.

Change default Starting Intensity

Use the numeric keypad or [Level: UP] or [Level: DOWN] keys to change the desired default intensity between 1-9. Press [ENTER] to accept the new value.

To customize the console:

1. Press [Level: UP], [3], [ENTER]. The console will display CUSTOMIZE.
2. Press [Level: UP] or [Level: DOWN] to scan through the customize choices. Select the option you want to change by pressing [ENTER]. Then, use the [Level: UP] or [Level: DOWN] keys or the numerical keypad to change the value for the selected option. Press [ENTER] to accept the choice for that option.

Change units

Use the [Level: UP] and [Level: DOWN] keys to toggle between USA units and Metric units. Press [ENTER] to select your option.

Language

Use the [Level: UP] and [Level: DOWN] keys to view the choices (English, German, French, Spanish, Italian, Dutch, Portuguese, Japanese). Press [ENTER] to select your option.

Adjust upper LCD screen contrast

Use the [Level: UP] and [Level: DOWN] keys to increase or decrease the contrast level of the upper LCD (1-100). Press [ENTER] to select your option.

Operation - D-1 LCD Console

Adjust lower LCD screen contrast

Use the [Level: UP] and [Level: DOWN] keys to increase or decrease the contrast level of the lower LCD (1-100). Press [ENTER] to select your option.

Adjust upper LCD screen backlight

Use the [Level: UP] and [Level: DOWN] keys to increase or decrease the backlight level of the upper LCD (1-100). Press [ENTER] to select your option.

Adjust lower LCD screen backlight

Use the [Level: UP] and [Level: DOWN] keys to increase or decrease the backlight level of the lower LCD (1-100). Press [ENTER] to select your option.

Auto Repeat (Not Used)

3. To exit CUSTOMIZE, press the [CLEAR] key.

Machine Status Codes

To view maintenance information such as the run time in hours, number of workouts and distance, as well a machine type and software revision:

1. Press [Level: UP], [4], [ENTER]. The console will display MACHINE STATUS
2. Press [Level: UP] or [Level: DOWN] to scan through the choices to view. Press [CLEAR] to exit the machine status codes.

Machine run time in hours

Display the machine run time in hours. The console will display RUN HOURS #####.

Number of workouts

Display the number of times a workout key has been pressed. The console will display WORKOUTS #####.

Floors

Display the total floors traveled. The console will display FLOOR #####.

Software revision

Display the console software revision number. The console will display CONS 41375-###.

Operation - D-1 LCD Console

Machine type

Display the machine type the console is currently configured to. The console will display STAIRCLIMBER or other machine type.

Machine run time in hours since last cleared (used for maintenance)

Display the machine run time since last cleared. The console will display MAINT HOURS #####. This will provide the number of hours between service or maintenance calls. The machine run time is reset to zero in the following Diagnostics section.

Prog Checksum

Displays a 4 byte number that uniquely identifies the program binary image, this number can be used in conjunction with the version number to ensure that the correct image is stored in the console.

3. To exit MACHINE STATUS, press the [CLEAR] key.

Diagnostic Codes

Diagnostic codes are used to test various components of the machine such as the display, keyboard, serial port, alternator, and tachometer, as well as viewing the error log information and resetting the time between service or maintenance calls.

1. Press [Level: UP], [6], [ENTER]. The console will display DIAGNOSTICS
2. Press [Level: UP] or [Level: DOWN] to scan through the choices. Select the option you want to view by pressing [ENTER].

Test display

To test the LCD display, press [ENTER] when the message, DISPLAY TEST is displayed. The console screen alternates turning on all LCD segments and a representative program screen. Verify that all LCD segments turn on.

Test keyboard

To test all the keys on the keyboard, press [ENTER] when the message, KEY TEST is displayed. Then, press any key on the keyboard and that key's name will be displayed in the text line. Press [CLEAR] as the last key to exit this test.

Test serial port

To test the serial port, press [ENTER] when the message, SERIAL TESTS is displayed. This test performs a serial loop back test. Select the CSAFE RS-232 selection. You will need a loop-back test cable inserted into the appropriate connector port to successfully run this test. Console will display either PASS or FAIL.

Operation - D-1 LCD Console

Test alternator

To test the machine's alternator, press [ENTER] when the message, ALT TEST is displayed. This test verifies the alternator field routines through the console. Position yourself on the machine and press [Level: UP] for field on. After exercising briefly you should build up resistance. For field off, press [Level: DWN].

Test tach response

To test the machine's tachometer, press [ENTER] when the message, TACH TEST is displayed. Start exercising on the machine. The console should regulate the alternator resistance based on the tach signal to maintain approximately 2,000 RPMs while you are exercising. If not, there is a possible problem in the AC tap or field circuit. Check the alternator, the AC tap wire, the field wire, the diode, the terminal posts, and the main cable.

HR Test

Press Enter when the message HR Test is displayed. The screen will show the current BPM readings for the telemetry HR receiver.

3. To exit DIAGNOSTICS, press the [CLEAR] key.

To review the error log and reset the service timer:

1. Press [Level: UP], [7], [ENTER]. The console will display MAINTENANCE LOG.
2. Press [Level: UP] or [Level: DOWN] to scan through the choices. Select the option you want by pressing [ENTER].

Error log

To display the machine's error log, press [ENTER] when the message, ERROR LOG, is displayed. The console will report various error messages in the display window. The total amount of errors will be displayed in the upper right window. Note that only the highest priority reported error will be displayed. Errors are handled in two ways. First, as a non-fatal WARNING which will display the text message but continue system operation until you press the [CLEAR] key. The second way is a fatal ERROR which will stop the exercise and return the system to an idle intensity state. The console will display the error text and not let you restart the program unless power has been turned off and then back on. There are 16 error entries available.

Reset service time

To reset the time between service or maintenance calls, press [ENTER] when the message, MAINT HOURS is displayed. Press the [0] key, then [ENTER] to reset.

Operation - D-1 LCD Console

QA ID

N/A

Maintenance Hours

Maintenance hours will display the number of run time hours accumulated since the last time service time was reset.

3. To exit MAINTENANCE LOG, press the [CLEAR] key.

Configuration Codes

1. Press [Level: UP], [8], [ENTER]. The console will display CONFIGURATION.
2. Press [Level: UP] or [Level: DOWN] to scan through the choices. Select the option you want by pressing [ENTER].

Change Machine

Changes the machine type from StairClimber to StepMill® machine. Scroll through the screen until CHANGE MACHINE is displayed. Press (ENTER), then press [Level: UP] or [Level: DOWN] to scan through the choices. Select the machine type you want by pressing [ENTER].

Reset Data Set Up

Scroll through the screen until RESET DATA SET UP is displayed and press (ENTER). All customized customer settings will be cleared.

NOTE: The Console will need to be reconfigured.

Clear Error Log

Scroll through the screen until CLEAR ERROR LOG is displayed and press (ENTER). The word DONE will appear and all accumulated errors in the Error Log will be cleared.

Reset Console

Scroll through the screen until RESET CONSOLE is displayed and press (ENTER). Resets all defaults to original manufacturing settings.

NOTE: The Console will need to be reconfigured.

Update Software

Load new software file (.uc3 extension) onto root directory of USB device and plug into USB port (note: there can only be one .uc3 file in the director). Press

Operation - D-1 LCD Console

[Enter] on Update Software menu choice to begin update, screen will go black and process will take about 20 seconds, upon completion the console will reboot and return to the main menu screen.

Operation - TS-1/TSE-1 Touchscreen Console

Understanding the Display and Controls

The SC5 console is a computerized panel used to operate the StairClimber® 5 display workout data and operational status. Take time to read through and familiarize yourself with the operation of the StairClimber® 5, and the location of all keys, to take full advantage of all of your machine's workout options.

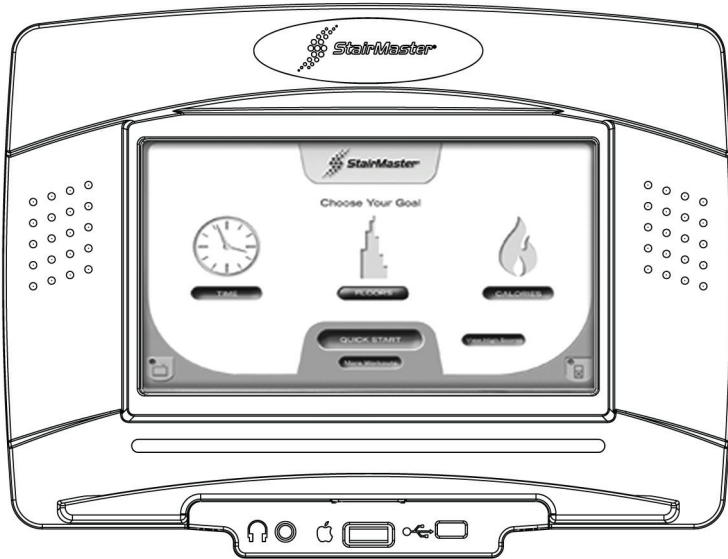

Display Definitions and Functions

Computer Display and Functions:

INTERVAL TIMER The interval timer is displayed in the center of the display window. The interval timer counts down the remaining time within each interval.

LEVEL Pressing the ↑ icon increases the workload intensity. Pressing the ↓ icon decreases the workload intensity.

HEART RATE Current Heart Rate (HR), in Beats Per Minute (BPM), is displayed next to the heart icon on the upper right display, if HR is detected.



User should consult a physician to determine an appropriate Target Heart Rate (THR) in which to exercise, based on age, weight and physical condition.

Operation - TS-1/TSE-1 Touchscreen Console

CURRENT CALORIES	Provides a current total of the number of calories burned during a workout.
ENDING CALORIES	Provides an estimate of the total calories that will be burned by the end of the workout, at the current work level. Note: This number is only an approximation as a user's caloric expenditure will vary significantly based on a person's age, gender, weight and metabolism.
FLOORS PER MINUTE	Displays the step rate in floors per minute (FPM).
LEVEL	Displays the current level from 1-20.
CURRENT FLOORS	Displays the current number of floors climbed.
ENDING FLOORS	Provides an estimate of the total floors that will be climbed by the end of the workout, at the current work level.
WATTS	During a workout, this statistic displays the power output at the current RPM and intensity level, displayed in watts (746 watts = 1 hp).
METs	MET (multiple of the resting metabolic rate) indicates the relative energy cost of exercise. While you are sitting quietly, your body consumes oxygen at the rate of 1 MET or about 3.5 milliliters per kilogram of body mass per minute. When you exercise, your body needs more oxygen in order to function. For example, exercising at 10 METs requires 10 times the resting rate of oxygen consumption, or about 35 milliliters per kilogram per minute. During a workout, the display shows the current MET level. During the workout summary, the average MET level is displayed. During your workout, keeping track of the METs will show you how hard you are working—the higher the MET level, the harder you are working.
WORKOUT PROFILE	The segmented area in the upper middle of the display shows the actual course profile of the selected exercise program. The taller the column, the higher the step rate and/or METs for that interval. The flashing column shows your current interval.

Operation - TS-1/TSE-1 Touchscreen Console

Button Functions

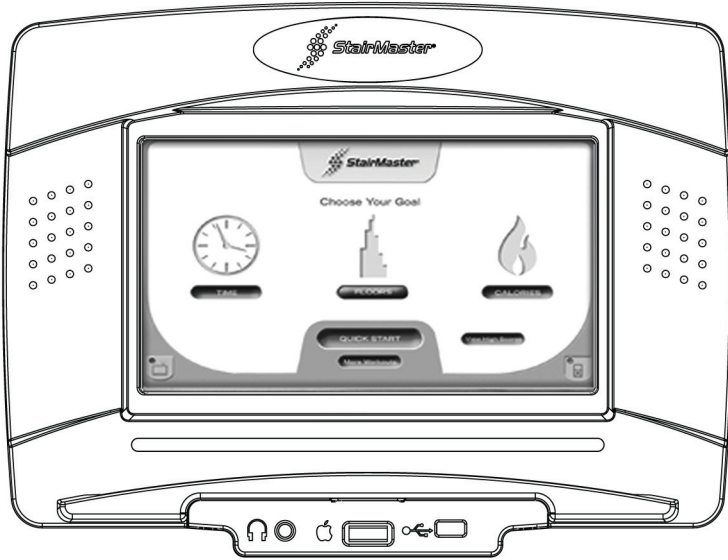

Workout Selection Buttons

The Workout Selection Buttons provide 3 workout goal options, a Quick Start button, and one key for More Workouts which includes multiple advanced workout options.

While the console is in SELECT WORKOUT mode, pressing one of the Workout Goal Buttons (Time, Calories or Floors) will select that goal, and screen will prompt to enter the specific goal information for the program chosen.

Once the goal is entered you will be prompted to select a workout profile, touch the icon for the desired profile. Profile options are: Manual, Fat Burner, Calorie Burner, Intervals, Bell-shaped, Build, Mystery Challenge, and Steady. See below descriptions of each profile.

Once the profile option is selected, screen will prompt to SET INTENSITY, from 1 (easiest) - 9 (hardest). Touch the bar to set desired intensity, touch ENTER to select.

After intensity is selected, screen will prompt to ENTER WEIGHT (in either lbs or kgs depending on setting of console) which is used for calorie calculation. Touch preset weight options, and use up/down arrows to set desired weight, touch ENTER to select.

Operation - TS-1/TSE-1 Touchscreen Console

MORE WORKOUTS

Pressing the More Workouts button provides access to three advanced workout options: HR Zone Trainer, CPAT Test and WFI Test. Touch the desired option on the screen to select.

QUICK START BUTTON

The Quick Start Button provides an immediate start to a workout session without having to provide any user information.

LEVEL (STEP RATE) UP & DOWN ICONS

The exercise Step Rate may be changed at any time during a workout. Pressing the **↑** key increases the step rate and pressing the **↓** key decreases the step rate.

PAUSE BUTTON

Press the PAUSE Key any time you want to pause the workout program for up to 2 minutes. Press the PAUSE Key a second time, and the workout statistics will be displayed, then the console will return to the SELECT WORKOUT prompt.

ENTER

The ENTER Key confirms workout selections and stores the information used by the console to calculate workout statistics.

BACK

During data entry, the CLEAR Key erases information from the console memory and backs up to the previous data entry prompt.

iPod CABLE

Console includes iPod connector cable to charge iPod/iPad/iPhone devices. Simply plug cable into device and control video and music content on-screen.

PROGRAMS

Time Goal

Time goal program allows you to enter a set amount of time you want to work out, and workout will continue over 30 time intervals to complete in desired amount of time.

Floor Goal

Floor Goal program allows you to enter a set number of floors you would like to climb during your workout. Based on your selected level of intensity, the console will calculate how long it will take you to complete the desired number of floors and workout will continue until completion.

Operation - TS-1/TSE-1 Touchscreen Console

Calorie Goal

Calorie Goal program allows you to enter a set number of calories you would like to burn during your workout. Based on your selected level of intensity, the console will calculate how long it will take you to burn the desired number of calories and workout will continue until completion.

The Quick Start Program

Provides an immediate start, without having to enter any user information. This program uses the standard default settings to calculate calories burned during a workout session.

1. Press the [QUICK START] key. The workout begins with exercise statistics accumulating.
2. During the workout:
The step rate may be changed at any time during the workout by pressing the UP arrow key to increase the step rate, or the DOWN arrow key to decrease the step rate. Any changes to the step rate will be displayed in the current flashing column. The new step rate will continue through the rest of the workout until changed using the Level keys.
3. Press [STOP] to pause the workout. Press [STOP] again to end the workout. The workout statistics will be displayed, and then the console will revert back to the SELECT WORKOUT message.

Manual Profile

Manual allows you to control the step rate of the StairClimber® 5 during the workout, while accurately calculating exercise statistics based on your weight. The workout profile in the display window is divided into 30 equal intervals within the selected workout goal.

Fat Burner Profile

Fat Burner is a 30-interval workout designed with moderate changes in intensity level designed to stimulate fat store assimilation for users on a weight control program. Any changes to speed during workout will change levels for rest of workout.

The Calorie Burner Profile

Calorie Burner is a 30 interval workout designed for users wanting to increase their aerobic capacity. The changes of the intensity in the program are greater than the changes in the Fat Burner program, and are designed specifically to tax the cardiorespiratory system. The profile in the center display indicates relative intensity. Any changes to speed during workout will change levels for rest of workout.

Operation - TS-1/TSE-1 Touchscreen Console

The Intervals Profile

Intervals is an interval workout containing 8 alternating rest intervals with 7 exercise intervals.

An interval cycle consists of a work phase and a rest phase. You may scale the rest intensity level and the work intensity level independently—which will be saved for the remainder of the workout.

Bell-Shaped Profile

The Bell-shaped is a 30 interval workout that steadily increases intensity for the first half of the workout, and then decreases over the second half of the workout. Any changes to Level during the workout will alter the remaining intervals in the profile by the same amount.

Build Profile

The Build is a 30 interval workout that steadily increases intensity over the course of the workout. Any changes to Level during the workout will alter the remaining intervals in the profile by the same amount.

Mystery Challenge Profile

The Mystery Challenge is a 30 interval workout with intensity changes randomly selected and applied to create a unique workout profile every time. Any changes to Level during the workout will alter the remaining intervals in the profile by the same amount.

Steady Profile

The Steady is a 30 interval workout that includes a warm-up period, then goes to a selected intensity level and remains there for the duration of the workout. Any changes to Level during the workout will alter the remaining intervals in the profile by the same amount.

Heart Rate (HR) Zone Trainer Profile

The HR Zone Trainer program allows you to exercise at a selected THR by automatically varying the intensity level (resistance) during the workout. The default THR is 100 beats per minute.

To choose a different THR (between 50 and 190 beats per minute) at any time during the workout, push the UP or DOWN arrows.

The HR Zone Trainer Program

1. Program requires telemetry HR chest belt. Remember to wet the electrodes underneath the chest strap. The console must detect a HR signal to allow selection of the HR Zone Trainer program.

Operation - TS-1/TSE-1 Touchscreen Console

2. After selection, the console will first display Checking for HR. When the console detects a valid signal from the HR belt it will then proceed to the next step.
3. The console will then display CHOOSE GOAL, TIME- CALORIES-FLOORS. Touch one of the three goal buttons.
4. The console will then prompt to enter goal information for selected goal.
5. Once goal information is selected screen will prompt to ENTER WEIGHT (in either lbs or kgs depending on setting of console) which is used for calorie calculation. Use number keys and up/down arrows to set desired weight, ENTER to select. If no weight is entered, machine will use default of 160 lbs/65 kg.
6. The workout will begin.

The following message may be displayed during a workout:

CHECK HR BELT	Indicates that the telemetry HR signal has been missing for the last 30 seconds.
----------------------	--

7. Press [PAUSE] to pause the workout. Press [STOP] to end the workout. The workout statistics will be displayed, and then the console will revert back to the SELECT WORKOUT message.

Options During a Workout

Once the workout begins, your workout statistics will begin to accumulate. The exercise statistics include, in order:

- **STEPS/MIN**
- **FLOORS/MIN**
- **FLOORS**
- **WATTS**
- **METS**
- **CALORIES**

Changing Step Rate (SR) or Target Heart Rate (THR) during a Workout

During the workout, the SR may be changed at any time during the workout by pressing the increase level, or the decrease level buttons. The console will display level and step rate.

In HR Control programs, you can use the numeric keys to change the THR.

When you change your THR, the console will gradually change the resistance to move you to the new THR.

Operation - TS-1/TSE-1 Touchscreen Console

Pausing Your Workout

The program enters the PAUSE state from a workout when the STOP key is pressed. The workout will be suspended, and the program will display the following buttons for up to 2 minutes: STOP or CONTINUE.

To exit the PAUSE state:

- At the end of the two minutes, the current workout ends, the accumulated exercise statistics are scrolled, and the program returns to the opening message.
- If the user presses [STOP], then the program ends, the accumulated exercise statistics are scrolled, and the program returns to the opening message.
- If the user presses the [CONTINUE] key, then the workout proceeds from where it was suspended.

End of Your Workout

The program is at the end of the workout when the workout goal is reached, or from the PAUSE state when the [STOP] key is pressed. At this point, each workout statistic is scrolled with averages calculated and displayed for TIME, CAL, Avg FLOORS/MIN, FLOORS, Avg WATTS, Avg METS.

After the statistics are scrolled, the program returns to the opening message.

CPAT Test Program

The first phase is a warm up interval at intensity of 56 step/min and lasts 20 seconds. At the end of the first interval the time counter will reset to zero.

The second phase continues through nine 20 second intervals at an intensity of 68 steps/min. The CPAT Stair Climb Test has a total of 10 intervals and lasts for 3 minutes, 20 seconds (including warm up).

Upon completion, screen displays TEST COMPLETE or INCOMPLETE.

WFI Test Program

The WFI test assesses the fire fighter's aerobic capacity expressed as VO_2 max. The results are calculated and recorded in milliliters (ml) of oxygen per kilogram (kg) of body weight per minute (VO_2 max).

These aerobic assessments are submaximal and are based on the heart rate response during graded exercise. Accurate estimation of maximal heart rate (MHR) is critical to the

Operation - TS-1/TSE-1 Touchscreen Console

submaximal prediction used in these assessments. A new formula for calculating maximal heart rate is utilized with these protocols, it more accurately accounts for age-related reduction of MHR. Be aware that the heart rate can be affected by variables such as body temperature, hydration state, anxiety, stress and medications. In addition to heart rate, body mass (height-to-weight ratio), is also a significant variable in both prediction equations. The relationship between height and weight is recorded as Body Mass Index (BMI). It is important to note that BMI is not being used in these aerobic protocols to estimate body composition; but rather, is used to represent the mass of each participant.

The test starts at 46 steps/min for 2 minutes, then 53 steps/min for 1 minute (warm-up period). The test time includes the warm-up time. The test is a series of 1-minute intervals with increasing work loads on each subsequent minute.

Note: Once the test starts, the user should not maintain a hold or lean on the handrails; this will result in overestimation of aerobic capacity.

The test is complete when the heart rate exceeds the Target Heart Rate (THR) for 15 seconds. The total Test Time (TT) begins from the time the user starts on the Stepmill, to the point at which the user exceeds their THR. It does not include the final 15 second qualification period that the heart rate was above the THR.

The qualification period is to verify the user's heart rate does not exceed the target, and then drop down to the THR or below for 15 seconds, if it does, then the test continues.

$$\text{Target HR} = [208 - (0.7 * \text{Age})] * 0.85$$

$$\text{BMI (in - lbs)} = 703 * \text{Weight (lbs)} / \text{Height (inches)}^2$$

$$\text{BMI (cm - kg)} = \text{Weight (Kg)} / \text{Height (cm/100)}^2$$

$$\text{VO}_2\text{max} = 57.774 + (1.757 * \text{time}) - (0.904 * \text{BMI})$$

Once the test is completed, the user should cool down for a minimum of 2 minutes at 39 steps/min.

The test is aborted with no results if any of the following occurs:

- The user stops or pauses the workout at any point during the test.
- The [STOP] key is pressed.
- The THR has not been met after 16 minutes previous work level.
- The Heart Rate signal is lost.
- The equipment malfunctions.

Operation - TS-1/TSE-1 Touchscreen Console

WFI Workout

1. Program requires telemetry HR chest belt. Remember to wet the electrodes underneath the chest strap. The console must detect a HR signal to allow selection of the HR Zone Trainer program.
2. After selection, the console will first display Checking for HR. When the console detects a valid signal from the HR belt it will then proceed to the next step.
3. Screen will walk you through entry of Weight, Age and Height information. These numbers are used in calculation of results, so for accurate results it is important to enter them correctly.
4. After successful completion of the WFI test, the following statistics will be displayed: EST VO2 MAX, HIGHEST STEP RATE, TOTAL TIME.

TS-1/TSE-1 SERVICE MENU OPTIONS

The touch screen consoles offer a variety of data and settings through the service menus. To access the main service menu, on the main workout selection screen, tap the top left corner, then the top right corner, and then the StairMaster logo in the top middle, one after the other.

Defaults

This menu allows you to set the default values for several workout inputs: Weight, Workout Time, Age, Target HR%, Starting Level and Step Rate.

Customize

This menu allows you to change custom settings on the console: Language and Units (Metric or US)

Machine Status

This menu displays a variety of information regarding the console software, setup, and usage (run hours, workouts, etc).

Diagnostics

This menu option provides access to three machine diagnostic tests: Alternator Test, Tach Test and Heart Rate Test.

Test alternator

To test the machine's alternator, press [ENTER] when the message, ALT TEST is displayed. This test verifies the alternator field routines through the console. Position yourself on the machine and press [Level: UP] for field on. After exercising briefly you should build up resistance. For field off, press [Level: DWN].

Operation - TS-1/TSE-1 Touchscreen Console

Test tach response

To test the machine's tachometer, press [ENTER] when the message, TACH TEST is displayed. Start exercising on the machine. The console should regulate the alternator resistance based on the tach signal to maintain approximately 2,000 RPMs while you are exercising. If not, there is a possible problem in the AC tap or field circuit. Check the alternator, the AC tap wire, the field wire, the diode, the terminal posts, and the main cable.

Heart rate test

Press [Enter] when the message HR Test is displayed. The screen will show the current BPM readings for the telemetry HR receiver.

Maintenance Logs

This menu displays errors that the machine encounters and records during operation.

Configuration

This menu allows setting of certain machine/console options: Equipment Type (StairClimber or StepMill, Max Workout Time, CSAFE On/Off, Cursor On/Off.

In addition, the menu allows you to Reset Console Data (return to defaults), Reset console, Clear Error Log, and Clear High Scores.

Utilities

This menu provides access to utility functions: TV Tuner Setup (this allows for adjustment of TV Tuner settings on the TSE-1 console), Touchscreen Calibration, Reset Configuration and Set the Time and Date in the Real Time Clock.

Manual Touchscreen Calibration

If screen calibration is so far off that it is not possible to access menus using the touchscreen, it is possible to enter calibration mode using a USB drive. Create a text file on the root directory of your USB drive titled: "touchscreen_calibration.txt". Inside the file should be the text: "touchscreen calibration". Insert the USB drive into the console and restart by turning power off and then back on. The console should restart at the touchscreen calibration screen.

To calibrate the touchscreen, touch each of the nine cross-hair locations in sequence, do not skip any. Then press the button labeled "Push After Calibration" to end calibration and return to the Home screen.

Maintenance

Maintenance Records

For ease of maintenance the SC5 StairClimber console will keep track of hours, number of workouts, time between last servicing, etc. You can quickly access any of the custom menus by pressing [LEVEL: UP], [4], [ENTER]. The console will then display "MACHINE STATUS." Use the [Level: UP] and [Level: DOWN] keys to scroll through the options. For details, refer to the Machine Status Console Codes in the previous section.

Resetting the Maintenance Hour Timer

After each maintenance period, reset the counter. Press [LEVEL: UP], [7], [ENTER]. Then use the Level keys to scroll through the options. When "MAINT HOURS" is displayed, press [ENTER]. Press the [0] key, then press [ENTER]. Press [CLEAR] to return to the opening screen.

Moving your SC5 StairClimber

Stand in front of the machine and grasp the handlebars. Pull down until the transport wheels are in contact with the ground.

Note: Do not push down on the plastic shroud with your feet when tilting the machine up to contact the transport wheels with the ground. Use the stabilizer bars instead, to avoid any damage to the plastic covers.

The machine can now be rolled on the transport wheels.

Note: The transport wheels are intended for indoor use only and should never be rolled on concrete or asphalt surfaces.

Initial Service

Upon receiving your machine, use a soft, clean towel to wipe off the dust, which may have accumulated during shipping. Your new machine will require minor assembly. Refer to the Assembly Manual for details.



The safety and performance of this product can be maintained only if it is inspected regularly for damage and wear.

Pay particular attention to components most susceptible to wear such as Contact Heart Rate housing, Foot pedal pads and Lower side covers.

Remove any damaged machine from service and replace damaged components immediately.

Direct any question regarding maintenance or its function to a qualified StairMaster® Technician. For contact information please see the Important Contact Numbers page at the back of this manual.

Maintenance

Maintenance Schedule

	Daily	Weekly	Monthly	Every 3 mos.	Comments
General Maintenance					
Check Safety & Warning Labels	X				
Spot Check Step Chains	X				
Lubrication					
Drive and Step Chains			Or every 300 hrs.		30W Oil
Leveling and Pedal Arm Shafts				Or every 900 hrs	Multi-Purpose grease
Spring Pulley and Pedal Shafts				Or every 900 hrs	Multi-Purpose grease
Cleaning					
Clean Console	X				Clean with a water dampened cloth and wipe dry after cleaning.
Clean Lower Side Covers	X				Clean exterior with soap and water or a diluted household cleaner.
Clean and Lubricate Pedal Springs		X			Clean, then wipe with lightly oil soaked rag.

Cleaning

1. Do not use glass cleaners or any other household cleaners on the console. Clean the console daily with a water-dampened cloth and wipe dry after cleaning.
2. Clean the exterior of the machine daily using soap and water or a diluted, non-mineral based household cleaner such as Fantastik®.

Inspection

1. Inspect the frame for any rust, bubbling, or paint chips during the daily cleaning. The salt in perspiration can damage the unpainted surfaces. Repair the damaged area with a touch-up paint kit purchased from StairMaster® Customer Service.

Parts and Service

Regular and scheduled maintenance will prolong the life of your StairMaster® equipment. Only use genuine StairMaster® replacement parts. The StairMaster® Customer Service Team invites you to call in your order for replacement parts.

Maintenance

Checking the Battery Charge

1. Using your multimeter, touch the red lead to the positive terminal a diluted, non-min of the battery and the black lead to the negative terminal.
2. If the voltage level is less than 6.1 VDC, charge the battery.

Charging the Battery Back-Up

The StairMaster® SC5 StairClimber is selfpowered (cordless) with a rechargeable battery back-up. Typically, the StairClimber can be operated without plugging in the external power supply. If, however, the console flickers during operation or the console display does not light up while using the machine, then use the external power supply to recharge the battery back-up.

The external power supply is supplied with the unit and plugs into a standard 115 volt, 15 amp outlet, or a 220 volt, 10 amp outlet. (All major voltage plugs are available.) The plug-in for the external power supply is located in the front of the machine at the base.

IMPORTANT: If you are using the TS-1 or TSE-1 consoles, the SC5 must be plugged in using the external power supply.

Plug the wall pack external power supply into the connector and charge the battery for approximately 24 hours and then recheck it. It is okay to use the machine while the external power supply is connected.

The console will power on as user starts to move the pedals of the machine, and will stay lit for up to 60 seconds in pause mode. The console will power off after 60 seconds of stopping exercise. The console will power on and remain powered whenever the external power supply is connected.

Battery Disposal

When ordering new batteries, you will need to properly dispose of (recycle) your old lead-acid batteries. Most federal and state regulations require lead-acid batteries to be recycled. Do not throw away old batteries. Lead is a toxic heavy metal, hazardous to living organisms.

Recycling

Do not dispose of this product as refuse. This product is to be recycled. For information on the proper method of disposal contact a StairMaster Customer® Service Representative.

If you have questions, contact the Customer Service Department at 1-888-678-2476.

Contact Information

CORPORATE HEADQUARTERS:

StairMaster

4400 NE 77th Ave., Suite 300

Vancouver, WA 98662 USA

Phone (888) 678-2476

www.stairmaster.com

Warranty

All warranty parts and technical support is provided by our in-house service team.

Phone: 1-888-678-2476, option 2

E-mail: parts@stairmaster.com

Please supply the serial number of your machine and the date of purchase when you call. Use the space in the boxes below to write down this information. To find the serial number on your machine, refer to the Safety Warning Label information page.

Please record the following information for future reference.

Serial Number

Date of Purchase

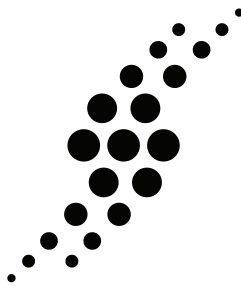

StairMaster[®]

© 2011 Core Fitness, LLC, dba StairMaster. All rights reserved. [™] and [®] indicates a trademark or registered trademark. Core Fitness, LLC trademarks include StairMaster[®], StepMil[®], Schwinn[®], A.C.[™], Smart Release[™], Ride Right[™], MPower[™], IC Pro[™], QuickFit[™], Triple Link[™] and respective logos. 1.888.678.2476, www.stairmaster.com. Other trademarks are the property of their respective owners.