

10 YEAR MANUFACTURER'S LIMITED WARRANTY

All parts of this Elements Of Design faucet are warranted to the original retail purchaser to be free from defects in material and workmanship for a period of ten(10) years from the date of purchase as shown on the purchaser's receipt. This warranty is limited to defective parts only, labor charges and/or damage resulting from improper installation, repair or replacements, as well as incidental and consequential damages connected therewith are excluded.

Any damage to this faucet as a result of misuse, abuse, neglect, accident for improper installation or any use not consistent with the instructions furnished by Elements of Design, will void this warranty. Replacement parts can be obtained from your local dealer.

CAUTION!!!

1. Water lines must be completely flushed before use, to avoid bris & clogs in your water system leading to malfunction and reduction of water flow.
2. Warranty to be void if water lines are not flushed before use of new faucet.
3. Use of abrasives of any strength may damage the finish of your faucet and void this warranty.

CODE APPROVAL: LA#M-000018

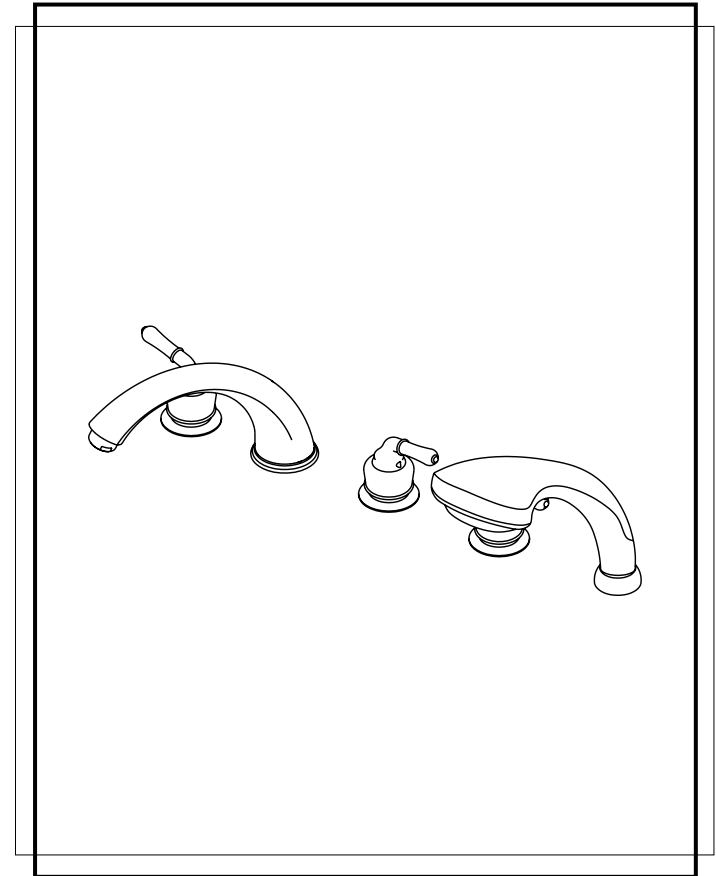

T 909.465.6687 F 909.548.6843 1877.FAUCET.1
www.eodfaucet.com
email: support@eodfaucet.com

INSTALLATION SHEET

NOTE:

1. FLUSH LINE BEFORE FAUCET INSTALLATION TO REMOVE DEBRIS IN LINES.
2. NO PLUMBER'S PUTTY ON ANY FINISH TO CORRODE FINISH OF FAUCET SURFACE.

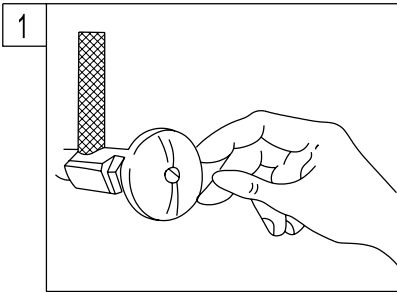
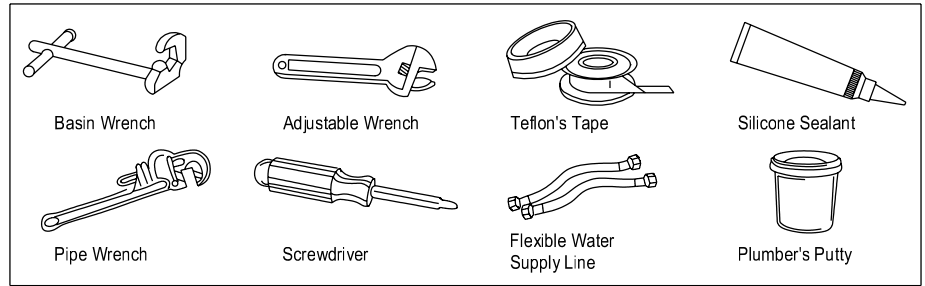

1. Shut off hot and cold water supply under sink. Plug sink drain with cloth to avoid losing small parts. Remove old faucet.

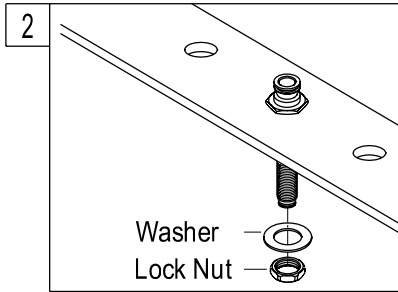

2. To keep spout from rotating after installation, screw brass pin into spout base. Then place spout escutcheon on over spout tube hub. Place mounting washer on spout shank and attach with spout shank locknut.

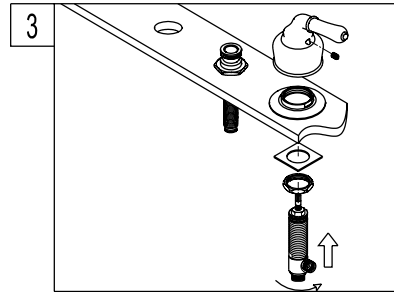

3. Hold the escutcheon of handle in proper position. Make sure that the top of the faucet handles is 5/8" above the top of the sink. Mount the metal washer and locknut from underneath the sink. Then reposition escutcheon as necessary to a desired height.

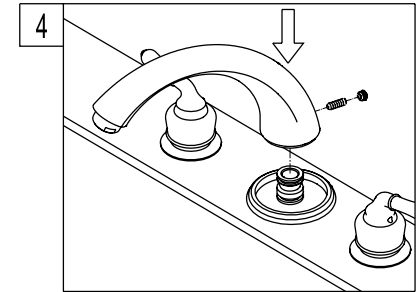

4. Place spout into spout hub. Complete installation by inserting set screw hole cover into access hole in back of spout.

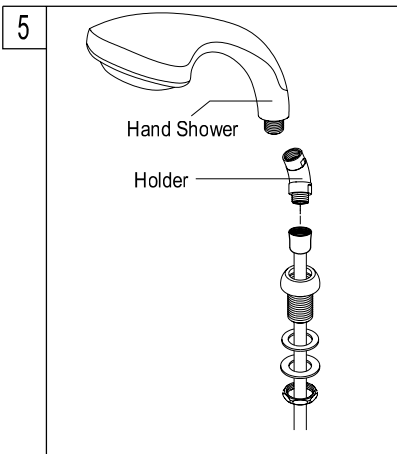

5. Apply thread sealant tape to threaded end of hose. Thread hose from top through the hand shower holder, and install tightly to the diverter valve. Attach hand shower.

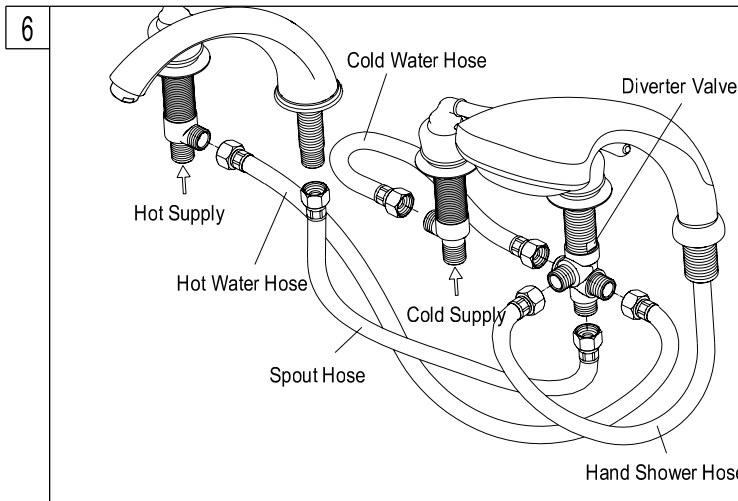

6. Connect the flexible tubes from the supply shank side port to the diverter valve. Also reattach the supply lines, turn on the water supply, and check for leaks.

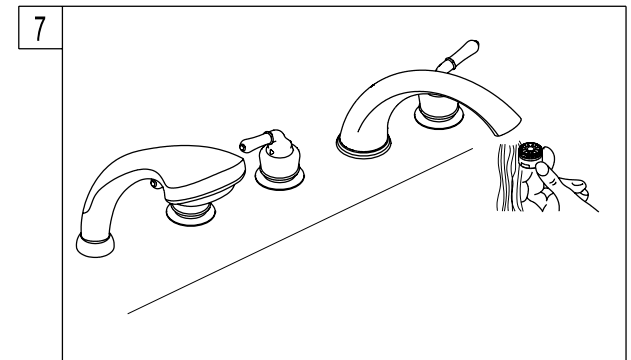

7. Remove the aerator before turning on your new faucet for the first time. Allow both hot and cold water to run for one minute. Replace aerator.